

buffet | tabletop | bar

# GASTRONOMIE- UND SERVIERARTIKEL

FOOD SERVICE EQUIPMENT  
EQUIPAMIENTOS PROFESIONALES  
EQUIPEMENT PROFESSIONNEL



# 2020

SINCE 1933

# „Enjoy the new APS catalogue 2020!“

APS - Mehrwert  
Inspiration & Service

APS - your added value  
inspiration and service

APS - su beneficio adicional  
inspiración y servicio

APS - votre bénéfice supplémentaire  
inspiration et service



**Reinhold Pott**  
managing director

**Johannes Becker**  
managing director

family-run company  
since 1933

Als inhabergeführtes Unternehmen in der 4. Generation legt APS viel Wert auf Kontinuität, Innovation und Vertrauen.

As a family-run company in the 4th generation, we value continuity, innovation and trust

Como empresa familiar administrada por la 4ª generación ponemos mucho énfasis en la continuidad, la innovación y la confianza.

En tant qu'entreprise familiale gérée par la 4ème génération, nous partageons nos valeurs en termes de continuité, d'innovation et de confiance.

## APS Germany



APS head office | Sundern Germany



APS production | stainless steel trays | Made in Germany



**Assheuer + Pott GmbH & Co. KG**

Talweg 11 | 59846 Sundern  
Germany

Phone: +49 (0) 29 33 / 97 35 - 0

E-Mail: [info@aps-germany.de](mailto:info@aps-germany.de)

[aps-germany.de](http://aps-germany.de)

buffet | tabletop | bar



Keep in touch  
[aps\\_germany](https://www.instagram.com/aps_germany)



Visit our  
website!



servicing ware & kitchen tools



S. 23



S.87



S.109

## Buffet & Display



S. 154



S. 199



S. 265

## Buffet & Tableware Melamin



S.269



S.315



S.339

## Tableware Tablepresentation



S.354



S.368



S.379

## Körbe baskets cestas corbeilles



S.382



S.401



S.422

## Chafing Dish, GN Container & Transport



S.429



S.438



S.479

## Bar Café Drinkware



S.496



S. 511



S.518

## Servier- & Küchenhelfer kitchen & serving tools herramientas de cocina outils de cuisine



S.532



S.534



S.535

## Hauben & Zubehör covers & accessories

# „NOVELTIES 2020 Design & Innovation“



FRIDA | S. 196



HAPPY BUFFET | S. 154 -155



S. 79



S. 84, 454

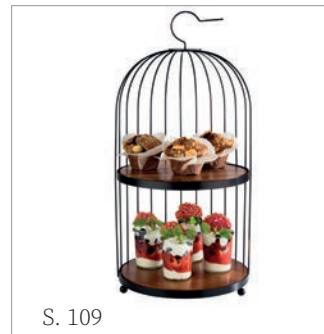

S. 109



S. 114



S. 440

*Streetfood  
Style*



S. 277



S. 277



S. 429



S. 441



S. 457

**Bar  
Café  
Drinkware**



S. 55

S. 54

S. 56

S. 57



ACACIA | S. 45, 293



CAST IRON | S. 270-271



Superboxen „VINTAGE“ | S. 23



S. 58



LOOPS | S. 182-183



INDUSTRIAL | S. 268

*Super trendy*



VINTAGE | S. 44, 269



S. 84, 429



S. 339



ENAMEL LOOK | S. 252



TIMBER | S. 212



POKE BOWL | S. 175

*Super trendy*



S. 256

**Buffet & Tableware  
Melamin**

# DEUTSCH

Artikel	Seite
<b>A</b>	
Abfalleimer	482-483
Abräumwagen	416-417
Abtropfmatte	458
Adapter / Zwischensteg	405
Allzweckgießer	332, 465-466
Antirutschmatte	166
Aschenbecher	478-483
Aufstrichmesser	508
Ausgießer	330, 461-462
Ausstellblech	516
Austernmesser	505
<b>B</b>	
Backblech	408
Backform	515
Backhandschuhe	517
Bain-Marie	382-383, 385-386, 388-396
Bar-Caddy	459
Barlöffel	448
Barmaß	445-447
Barmatte	458
Becher	437-442
Becher Emaille	279
Behälter	146-148
Bento Box	171
Beschriftungsetiketten	312
Beschriftungskarten	306
Besteckablage	259, 400
Besteckbehälter	27-28, 142-144, 146-148, 288, 300-302, 304, 341
Besteckständer	126, 147-148, 418
Besteckständer Melamin	126, 147, 418
Bestecktaschen	351
Beton	14-16, 150, 192-193, 308-310, 341, 344-346, 434, 481
Bierglasträger	62, 435, 474
Blattschale Melamin	195, 221, 250-251
Bonleiste	521
Bonspieß	521
Brennflüssigkeit	400
Brennpastenbehälter Edelstahl	399
Brezel- oder Wurstständer	59, 119
Brotstation	128, 379
Brotkorb	354-363, 367-369
Brotschneidebrett	128-129
Brötchenschütte	357
Brötchenspender Edelstahl	140
Brottasche	370-372
Buffet Kühlset	25
Buffet Kühlset Edelstahl	74-75
Buffet-Set	32, 39, 69
Buffetbrett	58-59
Buffet-Brücke	111
Buffetgestell	109-110, 112, 121, 126
Buffetleiter	122-125
Buffetschilder	308, 310, 312
Buffetständer	15, 35, 104-107, 126, 131, 199
Buffetständer Edelstahl	107, 173, 200, 377
Buffetständer Holz	15, 21, 104, 106
Buffetständer Metall	35, 105-107, 126, 173, 200
Buffetvitrine	67-68, 70-73
Buffetvitrine Edelstahl	70-73
Butter- und Saucenwärmer	294
Butterdose	334
Butterservierer	334
Bürste Bar	456

<b>C</b>	
Caddy	335-341
Cerealispender	27-28, 130-132
Cerealispender Edelstahl	131-132
Chafing Dish	382-393
Chafing Dish Rolltop	389-390, 392, 396
Champagnerkühler	430-431
Cocktailmesser	451, 504
<b>D</b>	
Darioiform	515
Deckel	26, 76-78, 124-125, 154, 168, 187, 204, 206, 215, 240, 243, 247, 254, 283, 393-395, 405-407, 410, 535-536
Deckel Edelstahl	386, 388
Dekoriermesser	451, 505
Dip-Schälchen	254-255
Dispenser Saft	27-28, 93, 95, 97-99, 101
Dispenser Saft / Milch	95, 97-98
Display	108
Dosier- & Vorratsflasche	461
Dosierer Zucker	331-333, 465-467
Dosierpumpe	524
Dosierspender	524
Dressingtopf Edelstahl	65-66
Dressingtopf Melamin	65-66
<b>E</b>	
Eier-Box	422
Eierbecher	259, 334
Eierkorb	372
Eierschneider	510
Eis-Kugel-Former	455
Eisbox	19, 84, 454
Eiseimer	426, 453
Eisportionierer	500
Eisschaufel	455
Eiswaffel-Ständer	522
Eiszerkleinerer	455
Emaille-Artikel	278-279, 334
Entkerner	504
Etagère	52, 113, 116, 118-119, 238
<b>F</b>	
Fadenschneider	503
Fast-Food Tablett	64, 423, 476
Fingerfood-Löffel	233, 260-261
Flambierbrenner	470, 510
Flaschenhalter Wein	435
Flaschenkühler	28, 426, 429-434, 437, 460
Flaschenöffner	460, 464
Flaschenträger	435
Fleisch- / Gemüseplatte	29
Folien-Abreibvorrichtung	521
Frischhaltedeckel	26, 283, 536
<b>G</b>	
Gabel Fleisch	412-413, 415, 488-489, 491, 495
Gabel Salat	415, 492, 494
Gebäckpalette	506
Genusspalette	53
Getränkspender	27-28, 86-102
Getränkewanne	429
Gewürzkasten	524
Gewürzmühle	314-319
Gewürzständer	329
Gläserschiene	435
Glasplatte	60, 109-110
Glasumrand	455
Glocke	483
Gourmetlöffel	296
GN Abtropfgitter	405-406
GN Behälter	401-404, 406-407, 409-411
GN Besteckbehälter	142, 361, 418

GN Buffet-Set	32
GN Buffetgestell	22-24, 110, 366
GN Buffetleiter	122-123
GN Buffetständer	173, 200
GN Buffetvitrine Edelstahl	70, 72
GN Chafing Dish	382, 385-386, 389-393
GN Deckel	404-407, 410
GN Haube	20-21, 32, 174, 190, 354, 364-365, 374, 411, 530-532
GN Konvektomatenblech	408
GN Korb	19, 374
GN Korb Metall	374
GN Korb Polypropylen	19, 354, 356, 361-364
GN Naturschieferplatte	23-24, 49-50
GN Partyplatte	40-41
GN Rost	408
GN Schale Melamin	154, 156, 158, 203, 205, 236, 240-241
GN Servierbrett	53
GN Serviergestell	120
GN Tablett	18, 24, 29, 33-34, 60-61, 160-161, 166-167, 176, 178, 181-182, 185, 187, 190, 193, 200, 204, 208, 211, 214, 218-219, 224, 232, 236, 239, 243, 248-249, 336, 409
GN Tablett Edelstahl	18, 29, 239
GN Tablett Melamin	18, 24, 60-61, 161, 166-167, 176, 178, 181-182, 185, 187, 190, 193, 200, 204, 208, 211, 214, 218-219, 224, 232, 236, 239, 243, 248-249, 336, 409
Gourmetgläser	281
<b>H</b>	
Haube	20-21, 32, 34, 37-38, 45-46, 48, 58-59, 104, 117, 163, 174, 190, 198, 216, 256-258, 289, 291-293, 354, 364-365, 374, 409, 411, 530-535
Haube Rolltop	37, 39, 51, 59, 69-75, 163, 258, 364, 396, 532-533
Haube Rolltop Edelstahl	396
Heizelement	94, 397-399
Hobel	59
Holzbox	57, 141, 287, 339-340
Hummerebrecher	510
Hygieneschutz	59, 119
<b>I</b>	
Induktionskochplatte	383-384, 386-388, 398
Isolierkanne	102-103
<b>K</b>	
Kaffeebecher	259
Kaffeedispenser Edelstahl	94, 102, 397
Kaffeekanne	102-103, 468
Kanne	82-83, 102-103, 467-468
Kanne Saft	82-83
Karaffe Glas	79-82
Kartenhalter	305-312
Käsehobel	505
Käseglocken-Set	39, 59
Kaviarkühler	42, 294
Kellnermesser	464
Kerzenleuchter	342-344
Konditorplatte	47-48, 216, 256-257, 290-291
Konferenzkühler	460
Korb Edelstahl	173, 364, 375-377
Korb Metall	161, 277, 373-376, 378-379
Korb Polypropylen	19, 299, 354-369, 421
Korkenzieher	464
Kronkorkenschale	460
Kugelausstecher	503
Kühlakku	26, 67-78, 81,

	87, 96, 460, 537
Kühlbox	17, 19, 25, 61, 69, 74-75
Kühlkaraffe	81
Kühlmanschette	434
Kühlschale	26, 76-78
Kühltablett	17, 71, 73
<b>L</b>	
Likör- und Fondanttrichter	513
Limettenpresse	452, 518
Löffel	260-261, 296, 412-415, 487-495, 500-502, 512
Löffel Backen	512
Löffel Feinkost	501
Löffel Fingerfood	233, 260-261
Löffel Frittieren	512
Löffel Gourmet	296
Löffel Salat	415, 492, 494
Löffel Saucen, Dressing	415, 493, 495, 501
Löffel Spaghetti	414, 493
<b>M</b>	
Magnet-Messerhalter	521
Mandoline	513
Menage	248, 323-329
Messbecher	514
Messlöffelsatz	500
Metallrahmen für Induktionskochplatte	386-388, 398
Milchgießer/-kännchen	85, 333, 467-469
Milchkanne	99-100
Minis	262-265
Moscow Mule Becher	437-439
Mühle Pfeffer	314-319
Mühle Salz	314-319
Multi Rack Edelstahl	135-136
Multibox	140
Muscheltopf	283
Müslispender	27-28, 130-132
<b>N</b>	
Naturschiefer	23-24, 39, 49, 50-52, 54, 118-119, 286, 288-289, 319, 475
Naturschieferplatte	23-24, 50-51, 288-289
<b>P</b>	
Palmbattschale Melamin	250-251
Parmesan Menage	328
Partyplatte	40-41
Pastateller Melamin	249
Pendelschäler	504
Permanent-Ausgießer	462
Pfanne	526
Pfannenwender	415, 486, 491, 494
Pfeffermühle	314-319
Pinself	518
Pinzettzange	456, 497
Pitcher	83, 435
Pizzaform	527
Pizzaschaufel	509, 517
Pizzaschneider	509
Platzsets	347-351
Platzteller	297
Pommes-Frites-Seiher	512
Porzellan	383, 388
<b>Q</b>	
Quetschflasche	523
<b>R</b>	
Rechnungstablett	313, 477
Reinigungsbürste	456-457
Rezeptionsglocke	483
Rolltop-Set	39, 51
Rührglas	461

**S**

Saftdispenser	27-28, 95, 97-99, 101
Saftkanne	82-83
Salzmühle	314-319
Sauciere	295
Schälchenspender	136-137
Schale Beton	14-16
Schale Edelstahl	26, 34, 276, 376
Schale Emaille	278-279, 334
Schale Holz	57, 284
Schale Melamin	26, 78, 121, 137, 154-159, 168, 175, 177, 179-180, 183-184, 186-187, 189, 191-193, 195, 198, 201-208, 212, 215, 221-223, 225-229, 231-232, 234-243, 246-255, 258, 262-265, 470
Schaufel Eis	455
Schaufel Mehl	517
Schaumlöffel	414, 487, 490-491
Schaumspesering	514
Schiefer	23-24, 39, 49-52, 54, 118-119, 286, 288-289, 319, 475
Schilder	308, 311, 536
Schlüsselschnur	463
Schneebesen	511
Schneidbrettständer	522
Schneidebrett	18, 128-129, 379, 451
Schöpflöffel	412-415, 487-490, 495
Sektkühler	426-429, 431-432
Senftöpfchen	325
Service Tower	134
Servier- / Tortenplatte Edelstahl	38, 47, 290
Servier- / Tortenplatte Holz	45, 117, 293
Servier- / Tortenplatte Melamin	46, 48, 183, 216, 256-257, 291-292
Servierbrett	53-57, 284-287, 341, 475
Serviergabel	415, 495
Serviergestell	114-116, 118-120, 282
Servierkelle	268, 471
Servierlöffel	412-415, 487-491, 494
Servierpfanne	35, 270-271, 275, 525, 526
Servierpfanne Schmiedeeisen	526
Servierpfanne Gusseisen	270-271, 525
Serviertablett	38, 42-44, 62-63, 269, 423, 472-475, 516
Servierwagen	416-417
Serviettenhalter	149-151
Serviettenringe	298
Serviettentaschen	351
Shaker	443-444
Sieb	449, 451, 511-513
Snackbox	268, 275
Snackholder	272-275
Snackpresenter	127
Sortierbox	422
Spachtel	508
Sparschäler	503
Speisenwärmer	382-391
Spießständer / Spieße	294
Spritzflasche	330, 461
Standascher	482-483
Ständer	199, 329, 428, 522
Ständer Wein- / Sektkühler	428
Staubkappen	463
Stielkasserolle	296
Stift	312
Stößel	450
Streichpalette	506
Streuer	320-322, 512
Streuer Pfeffer	314-319, 322
Streuer Salz	314-319, 322, 512
Superbox	22-24
Suppenkelle	492
Suppentopf	391, 394-396

Sushiboard Melamin	180-181, 185, 192, 207, 221, 223, 225, 230
<b>T</b>	
Table Caddy	146, 299, 335-336, 338-341
Tablett	18, 43-44, 62-63, 269, 313, 357, 409, 423, 472-477, 516
Tablett Edelstahl	18, 29-39, 42-44, 269, 313, 471-473, 477, 516
Tablett Fast Food	64, 423, 476
Tablett Holz	63-64, 162, 165, 336, 475, 476
Tablett Melamin	18, 24, 43, 60-62, 128, 160-161, 165-167, 176-178, 181-183, 185, 187, 190, 192-193, 199-202, 204-205, 207-211, 213-221, 223-225, 230-233, 236-241, 243-245, 248-249, 251, 258, 265, 319, 379, 472, 474
Tasse Melamin	259
Teebox	140-141
Teebrühsieb	85, 470
Teekanne ASIA	85, 467
Teigschaber / Abstecher	508
Teller Emaille	278
Teller Fingerfood	63, 194, 239, 259
Teller Melamin	63, 169, 177, 179, 180, 182, 184-185, 188, 194, 213, 222, 225, 230, 245-246, 252-253, 258-259, 264
Thermo Tablett-Set	67-68
Thermo-Set	75
Tischrestehbehälter	145-148, 302-304
Tischaufsteller	307, 311
Tischkartenhalter	305-310, 312
Tischkrümelentferner	147, 313, 477
Tischsets	347-350
Tortenheber	493, 495
Tortenmesser	493
Tortenplatte	38, 45-48, 117, 183, 216, 256, 257, 290-293
Tortenring	515
Transportwagen	416-417
Trenner	358
Tretbeutelhalter	483
Trinkbecher	89-93, 436
Trinkhalme	457
Tropfenschale Melamin	90-91, 93
<b>U</b>	
Universalbox	139-140, 524
Universalkanne	85, 468, 514
Untersetzer Edelstahl	298
Untersetzer Kork	89-92, 526
Untersetzer Naturschiefer	51, 289, 319
<b>V</b>	
Vase	346
Verschluss	462-463
Verschluss Wein / Champagner	462
Vorratsglas	138-139, 519-520
<b>W</b>	
Wachspapier	53, 269, 275
Wanne	18, 84, 423, 429
Warenträger	40, 347
Wärme-Kies	400
Warnschild	527, 537
Wasserbadschüssel	513
Wasserspender	86-93, 97
Weck Gläser	280-282
Wein-Vakuum-Pumpe	463
Weinkühler	426-429, 431-432
Weinkühlerständer	428
Weinpumpe-Ersatzstopfen	463
Wender	413-415, 486, 489-491, 494, 506, 507
Windaschenbecher	478-481
Windlicht	345

**Z**

Zange	456, 487, 496-500
Ziseliermesser	503
Zitronenschnitzelpresse	470
Zitruspresse	451, 518
Zitrusteiler	452
Zuckerdosierer	331-333, 465-467
Zuckerkugel	333, 470
Zuckerspender	333, 467
Zuckertüten-Box Edelstahl	469
Zutatenbehälter	459
<b>item</b>	<b>page</b>
<b>A</b>	
adapter	405
airtight cover	26, 283, 536
ashtray	478-483
<b>B</b>	
bain marie bailing bowl	513
bain marie	382-383, 385-386, 388-396
baking mittens	517
baking pan	515
baking sheet	408
bar caddy	459
bar knife	451, 504
bar shaker	443-444
bar spoon	448
barrel mug	437-442
basket metal	161, 277, 373-376, 378-379
basket polypropylene	19, 299, 354-369, 421
basket stainless steel	173, 364, 375-377
beaker	279
beer rack	62, 435, 474
Bento Box	171
beverage dispenser	27-28, 86-102, 459
beverage tub	429
bill presenter	313, 477
bill rail	521
bill spike	521
bottle cooler	28, 426, 429-434, 437, 460
bottle fuel	399
bottle opener	460, 464
bottle rack	435
bowl concrete	14-16
bowl enamel	278-279, 334
bowl holder	136-137
bowl melamine	26, 78, 121, 137, 154-159, 168, 175, 177, 179, 180, 183-184, 186-187, 189, 191-193, 195, 198, 201-208, 212, 215, 221-223, 225-229, 231-232, 234-243, 246-255, 258, 262-265, 470
bowl stainless steel	26, 34, 276, 376
bowl wood	57, 284
bread basket	370-372
breadbox	354-363, 367-369
brush	518
buffet bridge	111

buffet ladder	122-125
buffet set	32, 39, 69
buffet signs	308, 310, 312
buffet stand	15, 35, 104-107, 126, 109-110, 112, 121, 131, 199
buffet stand chrome plated steel	35, 105-107, 126, 173, 200
buffet stand stainless steel	107, 173, 200, 377
buffet stand wood	15, 21, 104, 106
Buffett-board	58-59
butter and sauce pan warmer	294
butter dish	334
<b>C</b>	
caddy	335-341
cake lifter	493, 495
cake plate melamine	46, 48, 183, 216, 256-257, 291-292
cake plate stainless steel	38, 47, 290
cake plate wood	45, 117, 293
cake setting ring	515
cake slice	493
cake stand	38, 45-48, 117, 183, 216, 256-257, 290-293
candle holder	342-344
canele / decorating knife	503
canister with lid	138-139, 519-520
cap bowl	460
cast iron pan	270-271, 525
caviar cooler	42, 294
cereal dispenser	27-28, 130-132
cereal dispenser stainless steel	131-132
Chafing Dish	382-393
Chafing Dish Rolltop	389-390, 392, 396
champagne bowl	426-429, 431-432
champagne saver	462
cheese dish	328
cheese slicer	505
chefs blow torch	470, 510
chopping board	18, 128-129, 379, 451
citrus squeezer	451, 518
citrus wedger	452
cleaning brush	456-457
clingfilm tear-off dispenser	521
cloche / dome cover	483
coaster cork, wood	89-92, 526
coaster natural slate	51, 289, 319
coaster stainless steel	298
coffee cup	259
coffee dispenser stainless steel	94, 102, 397
coffee pot	102-103, 468
condiment container	524
condiment holder	459
confectionery funnel	513
conference bottle cooler	460
container	18, 84, 146-148, 423, 429
cool collar	434
cooler	26, 67-78, 81, 87, 96, 460, 537
cooling bowl	26, 76-78
cooling box	17, 19, 25, 61, 69, 74-75
cooling carafe	81
cooling plates	17, 71, 73
corer	504
corkscrew	464
cornet stand	522
cover	20-21, 26, 32, 34, 37-38, 45-46, 48, 58-59, 76-78, 104, 117, 124-125, 154, 163, 168, 174, 187, 190, 198, 206, 215-216, 240, 243, 247, 254, 256-258, 283, 289, 291-293, 354, 364-365, 374, 405-407, 409-411, 530-536

 **ENGLISH**

cover stainless steel	386, 388	GN tray	18, 24, 29, 33-34, 60-61, 160-161, 166-167, 176, 178, 181-182, 185, 187, 190, 193, 200, 204, 208, 211, 214, 218-219, 224, 232, 236, 239, 243, 248-249, 336, 409	natural slate tray	23-24, 50-51, 288-289	snackbox	268, 275
crumber	147, 313, 477	GN tray melamine	18, 24, 60-61, 161, 166-167, 176, 178, 181-182, 185, 187, 190, 193, 200, 204, 208, 211, 214, 218-219, 224, 232, 236, 239, 243, 248-249	non slip mat	166	snackpresenter	127
cup melamine	259	GN tray stainless steel	18, 29, 239	<b>O</b>		snap mesh tea ball	85, 470
curler	59	GN-container	401-404, 406-407, 409-411	oyster knife	505	soup ladle	492
cutlery	14-16, 150, 192-193, 308-310, 341, 344-346, 434, 481	GN-convection oven trays	408	<b>P</b>		soup pot	391, 394-396
cutlery bag	351	GN-drainer	405-406	palm leaf melamine	250-251	spaghetti spoon	414, 493
cutlery basket	126, 147-148, 418	GN-lid	404-407, 410	pan	35, 270-271, 275, 525-526	spatula	506
cutlery basket melamine	126, 147, 418	gourmet glasses	281	paring knife	358	spice mill	314-319
cutlery organizer	27-28, 142-144, 146-148, 288, 300-302, 304, 341	graduated jug	514	party spoon	233, 260-261, 296	spider spoon	512
cutlery rest	259, 400	granite chips	400	partytray	40-41	spoon	260-261, 296, 412-415, 487-495, 500-502, 512
cutting board	128, 129	gravy boat	295	pasta plate melamine	249	squeeze bottle	330, 461, 523
cutting board rack	522	greaseproof paper squares	53, 269, 275	pastry spatula	506	stand for wine / champagne bowl	428
<b>D</b>		<b>H</b>		pedal bin	483	standing ashtray	482-483
dariol moulds	515	heating unit	94, 397-399	peeler	503	strainer	449, 451, 511-513
decorating knife	451, 505	hygienic cover	59, 119	pen	312	straws	457
decorator / zester	503	<b>I</b>		pepper mill	314-319, 322	sugar dispenser	331-333, 465-467
delicatessen spoon	501	ice ball former	455	pitcher	82-83, 102-103, 435, 467-468	sugar pocket holder	469
designation cards	306	ice box	19, 84, 454	pizza cutter	509	sugar pot	333, 470
dip bowl	254-255	ice bucket	426, 453	pizza dish	527	superbox	22-24
dispenser	27-28, 86-102	ice cream scoop	500	pizza peel	509, 517	sushiboard melamine	180-181, 185, 192, 207, 221, 223, 225, 230
dispenser dosing	524	ice crusher	455	placemat	347-350	swivel peeler	504
dispenser sugar	331-333, 465-467	ice scoop	455	plate enamel	278	<b>T</b>	
display	40, 108, 347	induction plate	383-384, 386-388, 398	plate melamine	63, 169, 177, 179-180, 182, 184-185, 188, 194, 213, 222, 225, 230, 245-246, 252-253, 258-259, 264	table caddy	146, 299, 335-336, 338-341
display tray	516	<b>J</b>		plate tray	297	table garbage bin	145-148, 302-304
dosing pump	524	jigger	445-447	plate warmer	382-391	table stands	305-312
dough scraper	508	jug	85, 468, 514	porcelain	383, 388	tea-box	140-141
dressing pot melamine	65-66	juice and milk dispenser	95, 97-98	pourer	332, 465-466	teapot ASIA	85, 467
dressing pot stainless steel	65-66	juice dispenser	27-28, 93, 95, 97-99, 101	pourer cleaning brush	456	thermo set	75
dressing/sauce spoon	415, 493, 495, 501	juice pitcher	82-83	pourers	330, 461-462	thermo tray	67-68
drinking cups	89-93, 436	<b>K</b>		pouring container	461	tong	456, 487, 496-500
drip mat	458	key cord	463	pretzel-/ sausage stand	59, 119	tray	18, 29, 38, 42-44, 52, 62-63, 113, 116, 118-119, 238, 269, 313, 357, 409, 423, 472-477, 516
drip tray	90-91, 93	<b>L</b>		<b>R</b>		tray melamine	18, 24, 43, 60-62, 128, 160-161, 165-167, 176-178, 181-183, 185, 187, 190, 192-193, 199-202, 204-205, 207-211, 213-221, 223-225, 230-233, 236-241, 243-245, 248-249, 251, 258, 265, 319, 379, 472, 474
dust & fly cap	463	labeling labels	312	refrigerated buffet display	25	tray stainless steel	18, 29-39, 42-44, 269, 313, 471-473, 477, 516
<b>E</b>		labels	308, 311, 536	refrigerator butter dish	334	tray wood	63-64, 162, 165, 336, 475-476
egg basket	372	ladle	412-415, 487-490, 495	ring bell	483	turner	413-415, 486, 489-491, 494, 506-507
egg cutter	510	leaf melamine	195, 221, 250-251	roll / bun basket	357	tweezer	456, 497
egg holder	259, 334	lemon slice squeezer	470	roll dispenser stainless	140	<b>U</b>	
eggs box	422	lime press	452, 518	rolltop cover	37, 39, 51, 59, 69-75, 163, 258, 364, 396, 532-33	universal box	139-140, 524
enamel	278-279, 334	lobster cracker	510	rolltop set	37, 39, 51, 59	<b>V</b>	
<b>F</b>		<b>M</b>		rolltop-cover stainless steel	396	vacuum jug	102-103
fingerfood plate	63, 194, 239, 259	magnetic knife rack	521	<b>S</b>		vacuum wine pump	463
flower vase	346	mandolin	513	salad fork	415, 492, 494	<b>W</b>	
fork	415, 495	meat platter	400	salad spoon	415, 492, 494	waiter's corkscrew	464
frame for induction plate	386-388, 398	meatfork	412-413, 415, 488-489, 491, 495	salt mill	314-319, 322, 512	Weck-bottles	280-282
free flow pourer	462	melon baller	503	sandwich knife	508	whisk	511
fry dripping tray	512	menage	248, 323-329	sauté pan / mini sauce pan	296	wind lights	345
<b>G</b>		milk dispenser	99-100	scoop	517	wine bowl	426-429, 431-432
glass carafe	79-82	milk jug	85, 333, 467-469	scraper	508	wine pump stopper	463
glass plate	60, 109-110	mini bowl	262-265	service tower	134	winebottle-stand	435
glass rack	435	mixing glass	461	service trolley	416-417	woodbox	57, 141, 287, 339-340
glass rimmer	455	Moscow Mule barrel mug	437-439	serving board	53-57, 284-287, 341, 475	wrought-iron pan	526
GN 1/1 buffet set	32	mousse ring	514	servicing cup	272-275		
GN 1/1 dispenser	142, 361, 418	muddler	450	servicing spoon	412-415, 487-491, 494		
GN basket	19, 374	multi rack stainless steel	135-136	servicing stand	114-116, 118-120, 199, 282, 329, 428, 522		
GN basket metal	374	multibox	140	servicing stand/rack	329		
GN basket polypropylene	19, 354, 356, 361-364	mussel pot	283	servicing trolley	388-389, 416-417		
GN bowl, square melamine	154, 156, 158, 203, 205, 236, 240-241	mustard glass	325	servicing trowel	268, 471		
GN buffet ladder	122-123	<b>N</b>		set measuring spoon	500		
GN buffet stand	22-24, 110, 173, 200, 366	napkin bag	351	shaker	320-322, 512		
GN Chafing Dish	382, 385-386, 389-393	napkin holder	149-151	shape sorter	422		
GN cover	20-21, 32, 174, 190, 354, 364-365, 374, 411, 530-532	napkin rings	298	showcase	67-68, 70-73		
GN grid	408	natural slate	23-24, 39, 49-52, 54, 118-119, 286, 288-289, 319, 475	showcase stainless steel	70-73		
GN natural slate tray	23-24, 49-50			skewer rack/skewer	294		
GN partytray	40-41			skimmer	414, 487, 490-491		
GN refrigerated buffet display	70, 72			skimmer spoon	512		
GN serving board	53			slate	23-24, 39, 49-52, 54, 118-119, 286, 288-289, 319, 475		
GN serving stand	120			snack tray	64, 423, 476		



**artículos** **pág.**

**A**

abre ostras 505  
 abridor 460, 464  
 acumulador de frío 26, 67-78, 81, 87, 96, 460, 537  
 adaptador 405  
 aro anti-goteo 90-91, 93  
 aro de tarta 515  
 aro redondo para semifríos 514  
 azucarero 331-333, 465-467, 470  
 azucarero para bolsitas 469

**B**

bano maría 382-383, 385-386, 388-396  
 bajo plato 297  
 bandeja 18, 38, 42-44, 52, 62-63, 113, 116, 118-119, 238, 269, 313, 357, 409, 423, 472-477, 516  
 bandeja acero inoxidable 18, 29-39, 42-44, 269, 313, 471-473, 477, 516  
 bandeja autoservicio y snacks 64, 423, 476  
 bandeja de pizarra natural 2324, 39, 49-52, 54, 118-119, 286, 288-289, 319, 475  
 bandeja de vidrio 60, 109-110  
 bandeja isotérmica 75  
 bandeja madera 63-64, 162, 165, 336, 475-476  
 bandeja melamina 18, 24, 43, 60-62, 128, 160-161, 165-167, 176-178, 181-183, 185, 187, 190, 192-193, 199-202, 204-205, 207-211, 213-221, 223-225, 230-233, 236-241, 243-245, 248-249, 251, 258, 265, 319, 379, 472, 474  
 bandeja para sushi melamina 180-181, 185, 192, 207, 221, 223, 225, 230  
 bandeja party 40-41  
 bandeja pastelería 408, 516  
 bandeja tartas acero inoxidable 38, 47, 290  
 bandeja tartas madera 45, 117, 293  
 bandeja tartas melamina 46, 48, 183, 216, 256-257, 291-292  
 bandeja termo 67-68  
 bandejas refrigeradas 17, 71, 73  
 barra magnética para cuchillos 521  
 barreño botellines 429  
 batidor 511  
 bento box 171  
 bol refrigerado 26, 76-78  
 bolsa cubiertos 351  
 bomba de salsa 524  
 bomba de vacío para vino 463  
 bote con tapa 138-139, 519-520  
 bote dosificador flexible 523  
 bote vertedor universal 332, 465-466  
 botella „store & pour“ 461  
 botella de combustible líquido 399  
 botella exprimible 330, 461  
 brocha 518

**C**

caballetes de mesa 307, 311  
 cacerola 526  
 caddy de mesa 146, 299, 335-341  
 cafetera 102-103, 468  
 caja de pan para buffet 354-363, 367-369  
 caja dispensadora 139-140, 524  
 caja madera 57, 141, 287, 339-340  
 caja para huevos 422  
 caja para té 140-141

caja surtida 422  
 cajón para cubiertos 27-28, 142-144, 146-148, 288, 300-302, 304, 341, 418  
 calentador de mantequilla y salsa 294  
 calienta platos 382-391  
 campana 20-21, 32, 34, 37-38, 45-46, 48, 58-59, 104, 117, 163, 174, 190, 198, 216, 256-258, 289, 291-293, 354, 364-365, 374, 409, 411, 530-535  
 campana abatible 37, 39, 51, 59, 69-75, 163, 258, 364, 396, 532-533  
 campana esférica 483  
 campana rolltop 396  
 candelabro 342-344  
 carro de servicio 416-417  
 cazo para baño maría 513  
 cazo recto bajo 96  
 cenicero 478-483  
 cenicero de pie 482-483  
 cepillo de limpieza 456-457  
 cesta acero inoxidable 173, 364, 375-377  
 cesta de huevos 372  
 cesta metal 161, 277, 373-376, 378-379  
 cesta para bollos 357  
 cesta para cubiertos 126, 147-148  
 cesta para cubiertos melamina 126, 147, 418  
 cesta polipropileno 19, 299, 354-369, 421  
 Chafing Dish 382-393  
 Chafing Dish Rolltop 389-390, 392, 396  
 coctelera 443-444  
 colador 449, 451, 511-513  
 conjunto aperitivo 248, 323-329  
 corta huevos 510  
 corta pasta 508  
 cortador de cítricos 452  
 cortador de pizza 509  
 cubeta 18, 84, 423, 429  
 cubierta higiénica antialiento 59, 119  
 cubiertos 14-16, 150, 192-193, 308-310, 341, 344-346, 434, 481  
 cubitera 19, 84, 454  
 cubitera isotérmica 426, 453  
 cubitera para vino y cava 426-429, 431-432  
 cubo champañera 430-431  
 cuchara 260-261, 296, 412-415, 487-495, 500-502, 512  
 cuchara de espaguetis 414, 493  
 cuchara gourmet 296, 501  
 cuchara para ensalada 415, 492, 494  
 cuchara para helado 500  
 cuchara para servir 412-415, 487-491, 494  
 cuchara party 233, 260-261  
 cucharilla de cóctel 448  
 cucharón 412-415, 487-490, 495  
 cucharón de salsa/alino 415, 493, 495, 501  
 cucharón de sopa 492  
 cuchillo acanalador 451, 505  
 cuchillo curvado 358  
 cuchillo de decoración cincelador 503  
 cuchillo para cóctel 451, 504  
 cuchillo para untar 508  
 cuenco acero inoxidable 26, 34, 276, 376  
 cuenco esmalte 278-279, 334  
 cuenco hormigón 14-16  
 cuenco madera 57, 284

cuenco melamina 26, 78, 121, 137, 154-159, 168, 175, 177, 179-180, 183-184, 186-187, 189, 191-193, 195, 198, 201-208, 212, 215, 221-223, 225-229, 231-232, 234-243, 246-255, 258, 262-265, 470  
 cuenco mini 262-265  
 cuenco para chapas 460  
 cuenco para dip 254-255

**D**

dispensador 27-28, 86-102  
 dispensador de bebidas 27-28, 86-102, 459  
 dispensador de bocadillos 127  
 dispensador de café acero inoxidable 94, 102, 397  
 dispensador de cereales 27-28, 130-132  
 dispensador de cereales acero inoxidable 131-132  
 dispensador de especias 459  
 dispensador de film 521  
 dispensador de leche 99-100  
 dispensador de panecillos acero inoxidable 140  
 dispensador de salsa 524  
 dispensador de zumo 27-28, 93, 95, 97-99, 101  
 dispensador en escalera 122-125  
 dispensador en escalera acero inoxidable 135-136  
 dispensador mixto zumo y leche 95, 97-98

**E**

embudo dosificador 513  
 enfriador de botellas 28, 426, 429-434, 437, 460  
 enfriador de caviar 42, 294  
 enfriador múltiple 460  
 escurridor de fritos 512  
 esmalte 278-279, 334  
 espátula 413-415, 486, 489-491, 494, 506-507  
 espátula plancha 508  
 especiero 524  
 espumadera 414, 487, 490-491  
 espumadera para fritos 512  
 esterilla antideslizante 166  
 esterilla escurridora 458  
 estructura o marco para placa de inducción 386-388, 398  
 etiquetas 308, 311-312, 536  
 expositor 40, 108, 347  
 expositor buffet 109-110, 112, 121, 126  
 expositor buffet frío 17, 19, 25, 61, 69-70, 72, 74-75  
 expositor de buffet 15, 35, 104-107, 126, 131, 199  
 expositor de buffet acero inoxidable 107, 173, 200, 377  
 expositor de buffet cromado 35, 105-107, 126, 173, 200  
 expositor de buffet madera 15, 21, 104, 106  
 exprimidor cítricos 451, 518

**F**

flaneras 515  
 florero 346  
 fuente de servicio 29  
 fuente en forma de hoja melamina 195, 221, 250-251  
 fuente para la mesa 35, 270-271, 275, 525-526  
 fuente servicio 400

funda de frío 434

**G**

GN 1/1 dispensador de cubiertos 142, 361, 418  
 GN 1/1 set de buffet 32  
 GN bandeja 18, 24, 29, 33-34, 60-61, 160-161, 166-167, 176, 178, 181-182, 185, 187, 190, 193, 200, 204, 208, 211, 214, 218-219, 224, 232, 236, 239, 243, 248-249, 336, 409  
 GN bandeja acero inoxidable 18, 29, 239  
 GN bandeja de pizarra natural 23-24, 49-50  
 GN bandeja melamina 18, 24, 60-61, 161, 166-167, 176, 178, 181-182, 185, 187, 190, 193, 200, 204, 208, 211, 214, 218-219, 224, 232, 236, 239, 243, 248-249  
 GN bandeja party 40-41  
 GN campana 20-21, 32, 174, 190, 354, 364-365, 374, 411, 530-532  
 GN cesta 19, 374  
 GN cesta metal 374  
 GN cesta polypropileno 19, 354, 356, 361-364  
 GN Chafing Dish 382, 385-386, 389-393  
 GN cubeta 401-404, 406-407, 409-411  
 GN cubeta para hornos de convección 408  
 GN cuenco cuadrado melamina 154, 156, 158, 203, 205, 236, 240-241  
 GN escurridor 405-406  
 GN rejilla 408  
 GN soporte buffet 120  
 GN soporte para buffet 173, 200  
 GN tabla de servir 53  
 GN tapa 404-407, 410  
 granulado térmico 400

**H**

huevera 259, 334

**I**

infusor de té, pinza con malla 85, 470

**J**

jarra 82-83, 85, 102-103, 435, 467-468, 514  
 jarra de leche 85, 333, 467-469  
 jarra de vidrio 79-82  
 jarra de zumo 82-83  
 jarra fría 81  
 jarra graduada 514  
 jarra termo 102-103  
 juego de cucharas medidoras 500

**L**

lavero enrollable 463

**M**

mandolina 513  
 manoplas de panadero 517  
 mantelín 347-350  
 mantequillera 334  
 mantequillera para nevera 334  
 marco pastelero 515  
 medidor jigger 445-447  
 mejillonera 283  
 molde de cubitos de hielo esféricos 455  
 molde de pizza 527  
 molinillo de pimienta 314-319, 322  
 molinillo de sal 314-319, 322, 512  
 molino de la especia 314-319  
 mortero 450  
 Moscow Mule taza 437-439  
 multibox 140

<b>O</b>	
olla para buffet	391, 394-396
organizador de bar	459
<b>P</b>	
pajás	457
pala	517
pala de hielo	455
pala de pizza	509, 517
pala de tartas	493, 495
paleta para servir	268, 471
paleta pastelera	506
panera	370-372
papel alimenticio	53, 269, 275
papelera de sobremesa	145-148, 302-304
pelador reversible	503-504
picadora de hielo	455
pie porta champañera / vino	428
piezas indicadores buffet	308, 310, 312
pinchanotas	521
pinza	456, 487, 496-500
pinza bogavante	510
pinza de emplatar	456, 497
pinza exprime limón	470
pizarra	23-24, 39, 49-52, 54, 118-119, 286, 288-289, 319, 475
placa de inducción	383-384, 386-388, 398
plato esmalte	278
plato melamina	63, 169, 177, 179-180, 182, 184-185, 188, 194, 213, 222, 225, 230, 245-246, 252-253, 258-259, 264
plato para el aperitivo	63, 194, 239, 259
plato para pasta melamina	249
polvoreador	320-322, 512
porcelana	383, 388
porcionador de pastel	493
porta botellas	435
porta cuenta	313, 477
porta vasos de cerveza	62, 435, 474
porta-etiquetas	305-310, 312
portafichas	521
portatarjetas	305-312
portavelas antiviento	345
posavasos acero inoxidable	298
posavasos corcho, madera	89-92, 526
posavasos pizarra natural	51, 289, 319
prensa de limón	452, 518
punteo de buffet	111
<b>Q</b>	
quesera parmesano	328
quita-rabillo	504
<b>R</b>	
rack de copas	435
rack dispensador para bols	136-137
rebanador de queso	505
recipiente organizador	146-148
recogemigas	147, 313, 477
reposa cuchara	259, 400
resistencia	94, 397-399
ribeteador de vasos	455
rizador	59
rotulador	312
<b>S</b>	
sacacorchos	464
sacacorchos de camarero	464
salsera	295
salsera acero inoxidable	65, 66
salsera melamina	65, 66
sartén de hierro fundido	270, 271, 525
sartén forjada	526
service tower	134
servilletero	149-151
servilleteros	298
set de buffet	32, 39, 69
set de buffet refrigerado	25
set rolltop	37, 39, 51, 59
snackbox	268, 275
soplete de cocina para flambear	470, 510
soporte	199, 329, 428, 522
soporte a pedal	483
soporte cucuruchos	522
soporte para botella de vino	435
soporte para brochetas	294
soporte para buffet	22-24, 110, 366
soporte para embutidos	59, 119
soporte para pastel	38, 45-48, 117, 183, 216, 256-257, 290-293
soporte para tablas	522
soporte platos	114-116, 118-120, 282
soporte salsas y condimentos	329
superbox	22-24
<b>T</b>	
tabla de corte	128-129
tabla de servir	53-57, 284-287, 341, 475
tabla para cortar	18, 128-129, 379, 451
tabla para el buffet	58-59
tapa	26, 76-78, 124-125, 154, 168, 187, 204, 206, 215, 240, 243, 247, 254, 283, 405-407, 410, 535-536
tapa de acero inoxidable	386, 388
tapa hermética	26, 283, 536
tapete escurridor	458
tapón antipolvo	463
tapón vertedor	462
tapones al vacío para el vino	463
tarjetas	306
tarros gourmet	281
taza	437-442
taza de café	259
taza melamina	259
tenedor de carne	412-413, 415, 488-489, 491, 495
tenedor de servicio	415, 495
tenedor de servicio para ensalada	415, 492, 494
tetera ASIA	85, 467
timbre	483
<b>V</b>	
vaciador de melón redondo	503
vaso coctelero	279
vaso mezclador vertedor	461
vaso para servir	272-275
vasos	89-93, 436
vasos mostaza	325
vertedor continuo	462
vertedores	330, 461-462
vitrina de buffet	67-68, 70-73
<b>W</b>	
Weck-botellas	280-282

## FRANÇAIS

item	pág.
<b>A</b>	
accumulateur de froid	26, 67-78, 81, 87, 96, 460, 537
adaptateur	405
anneau coupe-gouttes	90-91, 93
anneaux à serviettes 2	98
ardoise	23-24, 39, 49-52, 54, 118-119, 286, 288-289, 319, 475
assiette creuse mélamine	249
assiette de présentation	297
assiette émail	278
assiette mélamine	63, 169, 177, 179-180, 182, 184-185, 188, 194, 213, 222, 225, 230, 245-246, 252-253, 258-259, 264
assiette pour apéritif	63, 194, 239, 259
<b>B</b>	
bac	18, 84, 423, 429
bac à couverts	27-28, 142-144, 146-148, 288, 300-302, 304, 341
bain-marie	382-383, 385-386, 388-396
barre aimantée pour couteaux	521
barre porte-bons	521
base bois	57, 141, 287, 339-340
bassine à glace	429
Bento Box	171
beurrer	334
boîte à beurre pour le frigo	334
boîte à épices ou ingrédients	524
boîte à fruits et ingrédients	459
boîte à œufs	422
boîte à pain pour le buffet	354-363, 367-369
boîte à thés et infusions	140-141
boîte de tri	422
boîte distributrice	139-140, 524
bol béton	14-16
bol bois	57, 284
bol couvercle inox	26, 34, 276, 376
bol émail	278-279, 334
bol mélamine	26, 78, 121, 137, 154-159, 168, 175, 177, 179-180, 183-184, 186-187, 189, 191-193, 195, 198, 201-208, 212, 215, 221-223, 225-229, 231-232, 234-243, 246-255, 258, 262-265, 470
bol mélangeur	279
bol mini	262-265
bol récupérateur de capsules	460
bol réfrigéré	26, 76-78
bordeur à verres	455
bouchon à vide pour le vin	463
bouchon anti-poussières et anti-insectes	463
bouchons verseurs	330, 461-462
boule à thé avec pince	85, 470
bouteille „store & pour“	461
bouteille de combustible liquide	399
bouteille isotherme	102-103
bouteille verseuse souple	523
brosse lave	456-457
broyeur à glaçons	455
<b>C</b>	
caddy de table	146, 299, 335-336, 338-341
cadre support inox pour plaque induction	386-388, 398
caisson thermo	67-68
carafe en verre	79-82
casserole	526
casserole à moules	283
cendrier	478-483
cendrier sur pied	482-483
cercle à gâteaux	515
cercle à mousse rond	514
Chafing Dish	382-393
Chafing Dish Rolltop	389-390, 392, 396
chalumbeau e cuisine	470, 510
chandelier	342-344
chariot de service	416-417
chauffe-plat	382-391
chevalets de table	307, 311
cloche	20-21, 32, 34, 37-38, 45-46, 48, 58-59, 104, 117, 163, 174, 190, 198, 216, 256-258, 289, 291-293, 354, 364-365, 374, 409, 411, 530-535
cloche basculante	37, 39, 51, 59, 69-75, 163, 258, 364, 396, 532-533
cloche demi-sphère	483
cloche rolltop	396
coquetier	259, 334
corbeille	370-372
corbeille à petits pains	357
corbeille acier inox	173, 364, 375-377
corbeille métal	161, 277, 373-376, 378, 379
corbeille polypropylène	19, 299, 354-369, 421
coupe-agrumes	452
coupe-œufs	510
coupe-pâte	508
coupe-pizza	509
couteau à huitres	505
couteau à tarte	493
couteau à tartiner	508
couteau cannelé	451, 505
couteau cocktail	451, 504
couteau d'office bec d'oiseau	358
couteau tranche-fromage	505
couteau zesteur	503
couteau zesteur cannelé	503
couvercle	26, 76-78, 124-125, 154, 168, 187, 204, 206, 215, 240, 243, 247, 254, 283, 405-407, 410, 535-536
couvercle acier inox	386, 388
couvercle hermétique	26, 283, 536
couverts	14-16, 150, 192-193, 308-310, 341, 344-346, 434, 481
cuillère	260-261, 296, 412-415, 487-495, 500-502, 512
cuillère à cocktail	448
cuillère à glace	500
cuillère à salade	415, 492, 494
cuillère à sauce	415, 493, 495, 501
cuillère à spaghettis	414, 493
cuillère de service	412-415, 487-491, 494
cuillère gourmet	296, 501
cuillère party	233, 260-261
<b>D</b>	
décapsulateur	460, 464
dérouleur de film	521
distributeur	27-28, 86-102
distributeur à jus de fruit	27-28, 93, 95, 97-99, 101
distributeur à lait	99-100
distributeur de boissons	27-28, 86-102, 459
distributeur de café acier inox	94, 102, 397
distributeur de céréales	27-28, 130-132
distributeur de céréales acero inox	131, 132

distributeur de petits pains acier inox	140
distributeur mixte à lait et à jus de fruit	95, 97-98
doseur à sauce	524
<b>E</b>	
écumoire	414, 487, 490-491
écumoire à friture	512
égouttoir à couverts	126, 147-148, 418
égouttoir à couverts mélamine	126, 147, 418
égouttoir à friture	512
émail	278-279, 334
entonnoir à piston	513
équeuteur	504
étagère	52, 113, 116, 118-119, 238
étiquettes	306, 308, 311-312, 536
<b>F</b>	
flacon pulvérisateur	330, 461
forme à gateaux	515
fouet	511
fourchette à viande	412-413, 415, 488-489, 491, 495
fourchette de service	415, 495
fourchette de service pour la salade	415, 492, 494
frisette	59
<b>G</b>	
gants de boulanger	517
GN 1/1 bac à couverts	142, 361, 418
GN 1/1 set catering: plateau + cloche	32
GN bac	401-404, 406-407, 409-411
GN bac pour fours à convection	408
GN bol carré mélamine	154, 156, 158, 203, 205, 236, 240-241
GN Chafing Dish	382, 385-386, 389-393
GN cloche	20-21, 32, 174, 190, 354, 364-365, 374, 411, 530-532
GN corbeille	19, 374
GN corbeille métal	374
GN corbeille polypropylène	19, 354, 356, 361-364
GN couvercle	404-407, 410
GN égouttoir	405-406
GN grille	408
GN planche de service	53
GN plat ardoise naturelle	23-24, 49-50
GN plateau	18, 24, 29, 33-34, 60-61, 160-161, 166-167, 176, 178, 181-182, 185, 187, 190, 193, 200, 204, 208, 211, 214, 218-219, 224, 232, 236, 239, 243, 248-249, 336, 409
GN plateau acier inox	18, 29, 239
GN plateau mélamine	18, 24, 60-61, 161, 166-167, 176, 178, 181-182, 185, 187, 190, 193, 200, 204, 208, 211, 214, 218-219, 224, 232, 236, 239, 243, 248-249
GN plateau party	40-41
GN présentoir buffet	173, 200
GN support buffet	120
gobelet	437-442
gobelet à apéritif	272-275
gobelets	89-93, 436
gravier thermique	400
<b>H</b>	
housse isotherme	434
<b>J</b>	
jeu de cuillère à mesure	500

<b>L</b>	
louche	412-415, 487-490, 495
louche de service	492
<b>M</b>	
mandoline	513
marmite de buffet	391, 394-396
mesure jigger	445-447
Moscow Mule gobelet	437-439
moule à boule ronde simple	503
moule à glaçons en boules	455
moule à pizza	527
moules à flan	515
moulin à épices	314-319
moulin à poivre	314-319, 322
moulin à sel	314-319, 322, 512
multibox	140
<b>O</b>	
organisateur „bar caddy“	459
<b>P</b>	
pailles	457
panier à œufs	372
papier alimentaire	53, 269, 275
pare-haleine	59, 119
peleur	503
pelle à farine	517
pelle à gâteau	493, 495
pelle à glaçons	455
pelle à pizza	509, 517
petits chevalets de buffet	308, 310, 312
pichet	82-83, 85, 102-103, 435, 467-468, 514
pichet à café	102-103, 468
pichet à eau ou lait	85, 333, 467-469
pichet à jus de fruit	82-83
pichet gradué	514
pichet rafraîchisseur	81
pied pour seau à champagne / vin	428
pilon muddler	450
pince	456, 487, 496-500
pince à dresser	456, 497
pince à homard	510
pince presse citron	470
pinceau pâtissier	518
pique-bons	521
planche à découper	18, 128, 129, 379, 451
planche à découper buffet	58-59
planche de service	53-57, 284-287, 341, 475
plaque à induction	383-384, 386-388, 398
plaque à pâtisserie	408, 516
plat à gâteau acier inox	38, 47, 290
plat à gâteau bois	45, 117, 293
plat à gâteau mélamine	46, 48, 183, 216, 256-257, 291-292
plat à sauter	296
plat ardoise naturelle	23-24, 39, 49-52, 54, 118-119, 286, 288-289, 319, 475
plat ardoise naturelle	23-24, 50-51, 288-289
plat de service	29, 400
plat pour la table	35, 270-271, 275, 525-526
plateau	18, 38, 42-44, 62-63, 269, 313, 357, 409, 423, 472-477, 516
plateau bois	63-64, 162, 165, 336, 475-476
plateau buffet froid	70, 72
plateau couvercle inox	18, 29-39, 42-44, 269, 313, 471-473, 477, 516
plateau feuille mélamine	195, 221, 250-251

plateau mélamine	18, 24, 43, 60-62, 128, 160-161, 165-167, 176-178, 181-183, 185, 187, 190, 192, 193, 199-202, 204, 205, 207-211, 213-221, 223-225, 230-233, 236-241, 243-245, 248-249, 251, 258, 265, 319, 379, 472, 474
plateau party	40-41
plateau self-service et snacks	64, 423, 476
plateau sous-verre acier inox	298
plateau sushi mélamine	180-181, 185, 192, 207, 221, 223, 225, 230
plateau verre	60, 109, 110
plateaux réfrigérés	17, 71, 73
plucheur droitier/gaucher	504
pochette couverts	351
poêle à frire forgée	526
poêle en fonte	270-271, 525
pompe à sauce	524
pompe à vide pour le vin	463
pont de buffet	111
porcelaine	383, 388
porte condiments et sauces	329
porte verres à bière	62, 435, 474
porte-addition	313, 477
porte-bols	136-137
porte-bougies anti-vent	345
porte-bouteilles	435
porte-cartes	305-312
porte-clés avec câble à enroulement	463
porte-étiquettes à pince	305-310, 312
porte-sachets de sucre	469
porte-serviettes	149-151
pose-cuillère	259, 400
pot à épices	320-322, 512
pot à sauce acier inox	65-66
pot à sauce mélamine	65-66
pot en verre avec couvercle	138-139, 519-520
pot verseur universel	332, 465-466
poubelle à pédale	483
poubelle de table	145-148, 302-304
présentoir	40, 108, 347
présentoir à assiettes	114-116, 118-120, 282
présentoir à gâteaux	38, 45-48, 117, 183, 216, 256-257, 290-293
présentoir à sandwiches	127
présentoir buffet	15, 22-24, 35, 74-75, 104-107, 109-110, 112, 121, 126, 131, 199, 366,
présentoir buffet acier inox	107, 173, 200, 377
présentoir buffet bois	15, 21, 104, 106
présentoir buffet chromé	35, 105-107, 126, 173, 200
présentoir buffet de froid	17, 19, 25, 61, 69, 74-75
présentoir buffet en escalier	122-125
présentoir pour le buffet	32, 39, 69
presse citron	452, 518
<b>R</b>	
rack porte-verres	435
rack pour planches à découper	522
rafraîchisseur	460
rafraîchisseur de bouteilles	28, 426, 429-434, 437, 460
rafraîchisseur de caviar	42, 294
ramasse-miettes	147, 313, 477
ramequin	254-255
réchaud à beurre et sauce	294
réceptacle bain-marie	513
réceptacle de table	146-148

résistance	94, 397, 398-399
<b>S</b>	
saucière	295
seau à champagne	430-431
seau à glaçons	19, 84, 454
seau à glaçons isothermique	426, 453
seau à vin ou champagne	426-429, 431-432
service à parmesan	328
set apéritif	248, 323-329
set cloche à fromage	39, 59
set de table	347-350
set thermo	75
shaker	443-444
snackbox	268, 275
sonnette	483
soucoupes ardoise naturelle	51, 289, 319
soucoupes liège, bois	89-92, 526
spatule	413-415, 486, 489-491, 494, 506-507
spatule coudée spéciale grill	508
spatule pâtissière	506
stylo	312
sucrier	331-333, 465-467, 470
superbox	22-24
support	199, 329, 428, 522
support à bretzel ou à saucissons	59, 119
support à cornets	522
support multiple acier inox	135-136
support pour brochettes	294
<b>T</b>	
tamis	449, 451, 511-513
tapis antidérapant	166
tapis de bar	458
tapis égouttoir	458
tasse à café	259
tasse mélamine	259
théière ASIA	85, 467
tire-bouchons	464
tour de service	134
truelle de service	268, 471
<b>V</b>	
vase soliflor	346
verre mélangeur	461
verres à moutarde	325
verres gourmet	281
verseurs continus	462
vitrine de buffet	67-68, 70-73
<b>W</b>	
Weck-bouteilles	280-282





# Buffet & Display

**Tablets**  
**Karaffen**  
**Dispenser**  
**Buffetständer**  
**Isolierkannen**

bandejas  
jarras  
dispensadores  
soportes para buffet  
jarras termo

trays  
carafes  
dispensers  
buffet stands  
vacuum jugs

plateaux  
carafes  
distributeurs  
présentoirs buffet  
bouteilles isotherme

# ELEMENT



Bekannt aus dem Bereich der Inneneinrichtung, lässt sich Beton nun auch im Buffetbereich stilvoll einsetzen. ELEMENT bietet drei unterschiedliche Präsentationsschalen, die sehr ansprechend in jede rustikale, natürliche aber auch urbane Buffetlandschaft integriert werden kann.

Known from the interior design sector, concrete can now also be used stylishly in the buffet area. ELEMENT offers three different presentation bowls, which can be very attractively integrated into any rustic, natural but also urban buffet landscape.

Conocido del sector de diseño interior, ahora el homigón también puede ser utilizado en el área del buffet. ELEMENT ofrece tres cuencos de presentación diferentes, que pueden ser integrados atractivamente en cualquier paisaje de buffet rústico, natural, pero también urbano.

Connu dans le domaine du design d'intérieur, le béton peut désormais être utilisé avec élégance dans la zone du buffet. ELEMENT offre trois bols de présentation différents, qui peuvent être intégré très attrayante dans n'importe quel paysage de buffet rustique, naturel, mais aussi urbain.





Schale „ELEMENT“

bowl  
cuenco  
bol



	Ø cm	↑ cm	ltr.
30000	22	6,0 / 10,5	1,1



Schale „ELEMENT“

bowl  
cuenco  
bol



	Ø cm	↑ cm	ltr.
30001	26	7,5 / 13,0	1,7



Schale „ELEMENT“

bowl  
cuenco  
bol



	Ø cm	↑ cm	ltr.
30002	29,5	8,5 / 14,5	2,5



Buffetständer

buffet stand  
expositor de buffet  
présentoir buffet



Akazienholz  
acacia wood  
madera de acacia  
bois d'acacia

	Ø cm	↑ cm
33255	15	10



Buffetständer

buffet stand  
expositor de buffet  
présentoir buffet



Akazienholz  
acacia wood  
madera de acacia  
bois d'acacia

	Ø cm	↑ cm
33256	25	15

# COCONUT



Schale „COCONUT“

owl  
cuenco  
bol



	Ø cm	↑ cm	ltr.
30020	18	9,5	1



Schale „COCONUT“

owl  
cuenco  
bol



	Ø cm	↑ cm	ltr.
30021	23	12,5	2,2





# FRAMES



Die reduzierte, archetypische Formsprache von FRAMES nimmt sich elegant zurück und lässt damit viel Raum für die Inszenierung der Buffet-Speisen. Ein scheinbarer Widerspruch löst sich auf: das Design ist zeitgemäß und zeitlos zugleich.

Design in detail – The classic minimalist visual style of FRAMES is elegantly understated, leaving plenty of potential for creating appealing buffet arrangements. Its design transcends what at first seems to be an irreconcilable paradox, being at once both timeless and highly contemporary.



## Kühltablets SET 1 „FRAMES“

cooling plates  
bandejas refrigeradas  
plateaux réfrigérés



GN 1/1 Basiselement, GN 1/1 Edelstahl Tablett 18/10, Kühlakku  
GN 1/1 base element, GN 1/1 stainless steel platter 18/10, cooler  
elemento básico GN 1/1, bandeja GN 1/1 de acero inoxidable 18/10, acumulador de frío  
élément de base GN 1/1, plateau GN 1/1 inox 18/10, accumulateur de froid

	cm	↑ cm	GN	Farbe / Colour	
12940	53 x 32,5	8,5	1/1		stainless steel
14940	53 x 32,5	8,5	1/1		wenge wood
13940	53 x 32,5	8,5	1/1		ahorn wood



## Kühltablets SET 2 „FRAMES“

cooling plates  
bandejas refrigeradas  
plateaux réfrigérés



GN 1/1 Basiselement, GN 1/1 Edelstahl Tablett 18/10, Rolltop-Haube, Kühlakku  
GN 1/1 base element, GN 1/1 stainless steel platter, rolltop cover, cooler  
elemento básico GN 1/1, bandeja GN 1/1 de acero inoxidable 18/10, campana rolltop, acumulador de frío  
élément de base GN 1/1, plateau GN 1/1 inox 18/10, cloche rolltop, accumulateur de froid

	cm	↑ cm	GN	Farbe / Colour	
12941	53 x 32,5	27,5	1/1		stainless steel
14941	53 x 32,5	27,5	1/1		wenge wood
13941	53 x 32,5	27,5	1/1		ahorn wood

## Buffet & Display



### Schneidebrett „FRAMES“

chopping Board  
tabla para cortar  
planche à découper



**Ahorn, massiv**  
ahorn wood, solid  
madera de arce, masivo  
bois d'érable, massif

	cm		
13955	53 x 32,5	1/1	
13960	53 x 32,5	1/1	gerillt



### Schneidebrett „FRAMES“

chopping Board  
tabla para cortar  
planche à découper



	cm	GN
17910	53 x 32,5	1/1



### GN Edelstahl Tablett „FRAMES“

GN stainless steel platter  
GN bandeja acero inoxidable  
GN plateau acier inox



	cm	GN
11119	53,0 x 32,5	1/1
11118	32,5 x 26,5	1/2



### GN Tablett „FRAMES“

GN tray  
GN bandeja  
GN plateau



	cm	↑ cm	GN
84046	53,0 x 32,5	2	1/1
84047	32,5 x 26,5	2	1/2
84048	32,5 x 17,6	2	1/3



### GN Tablett „FRAMES“

GN tray  
GN bandeja  
GN plateau



	cm	↑ cm	GN
82355	53,0 x 32,5	2	1/1
82356	32,5 x 26,5	2	1/2
82357	32,5 x 17,6	2	1/3



### GN Polystyrolwanne „FRAMES“

GN polystyrene tray  
GN bandeja poliestireno  
GN plateau polystyrène



	cm	GN
17922	53 x 30	1/1



**Korb „GN LINE“**

GN basket  
GN cesta  
GN corbeille



**stabile Ausführung mit Edelstahldraht im Rand zur Stabilisierung**  
very solid with stainless steel wire frame to stabilize the basket  
muy resistente con refuerzo de alambre inox  
très résistante avec son fil de renfort inox

	cm	↑ cm	GN
40291	53,0 x 32,5	6,5	1/1
40290	32,5 x 26,5	6,5	1/2
40293	53,0 x 32,5	10,0	1/1
40292	32,5 x 26,5	10,0	1/2



**Buffetkorb**

buffet basket  
cesta de buffet  
corbeille de buffet



**Polyrattan, mit Haubenschiene (ohne Haube)**  
polyrattan, with frame to fix the (without cover)  
polyrattan, con fijación para campana (sin campana)  
polyrattan, avec fixation pour la cloche (sans cloche)

	Ø cm	↑ cm
40295	40	12,5



**GN Basket**

GN basket  
cesta GN  
corbeille GN



**Polyrattan, mit Haubenschiene (ohne Haube)**  
polyrattan, with frame to fix the (without cover)  
polyrattan, con fijación para campana (sin campana)  
polyrattan, avec fixation pour la cloche (sans cloche)

	cm	↑ cm
40294	56,5 x 36,0	10,0



**Rolltop-Haube**

rolltop cover  
campana abatible  
cloche basculante



	Ø cm	↑ cm
18389	38	20



**Eisbox „FRAMES“**

ice box  
bandeja para hielo para buffet  
caisse à glaçons pour le buffet



**3-teilig: 1 Basiselement Wenge + 1 Polystyrolwanne + 1 Tropfgitter**

3 pcs. set: 1 box wenge + 1 plastic deep tray + 1 drainer plate  
set de 3: 1 cajón color wengué, 1 cubeta plástico, 1 rejilla  
set de 3: 1 caisson couleur wengé, 1 bac plastique, 1 plaque perforée

	cm	↑ cm	GN	Farbe / Colour
14970	53 x 32,5	12,5	1/1	■

## Buffet & Display



**GN 1/1 Rolltop-Haube**  
 GN 1/1 rolltop cover  
 GN 1/1 campana abatible  
 GN 1/1 cloche basculante



	cm	↑ cm	GN
11018	53 x 32,5	17	1/1



**Besteck- / Universal-Box, 2-teilig „FRAMES“**  
 cutlery tray, 2 pcs.  
 cubertero o cajón multi-usos, 2pz.  
 caisson à couverts ou multi-usages



**Buche massiv, Wenge, 4 Fächer, inklusive herausnehmbaren Einsatz**  
 wood wenge, 4 compartments  
 madera de haya maciza, color wengué, 4 compartimentos, separadores removibles  
 hêtre massif, couleur wengé, 4 compartiments, séparateurs amovibles

	cm	↑ cm	GN	Farbe / Colour
14956	53 x 32,5	11	1/1	■

**Einsatz für GN 1/1 „FRAMES“ / insert for GN1/1 „FRAMES“ / interior para GN1/1 „FRAMES“ / insert pour GN1/1 „FRAMES“**

	cm	↑ cm	Farbe / Colour
14954	48,5 x 28	8	■



**Gestell für GN 1/1 „FRAMES“**  
 serving stand  
 cubertero o cajón multi-usos  
 caisson à couverts ou multi-usages



**Buche massiv, Wenge**  
 wood, wenge  
 madera de haya maciza, wengué  
 hêtre massif, wengé

	cm	↑ cm	Farbe / Colour
14953	57,5 x 27,5	22	■



**NEW ACACIA**

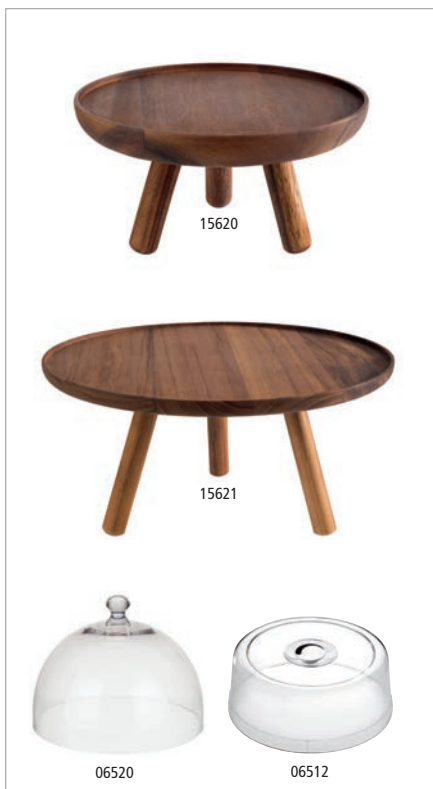

**Buffetständer „ACACIA“**

buffet stand  
soporte para buffet  
présentoir buffet



Akazienholz geölt / acacia wood oiled / madera de acacia aceitada / bois d'acacia huilé

	Ø cm	↑ cm
15620	20,0	10,5
15621	30,5	15,0
15622	30,5	20,0

**Frischhalte- Haube / cover / campana / cloche**



	Ø cm	↑ cm	fits to
06520	30	22	15621, 15622

**Frischhalte- Haube / cover / campana / cloche**



	Ø cm	↑ cm	fits to
06512	30	11,5	15621, 15622



**Buffetständer „ACACIA“**

buffet stand  
soporte para buffet  
présentoir buffet



Akazienholz geölt / acacia wood oiled / madera de acacia aceitada / bois d'acacia huilé

	cm	↑ cm	GN
15623	53 x 16,2	20	2/4

**GN Abdeckhaube / GN cover / GN cubierta/ GN cloche**



	cm	↑ cm	* mm	GN
11044	53 x 16,2	10,5	3	2/4

# SUPERBOX

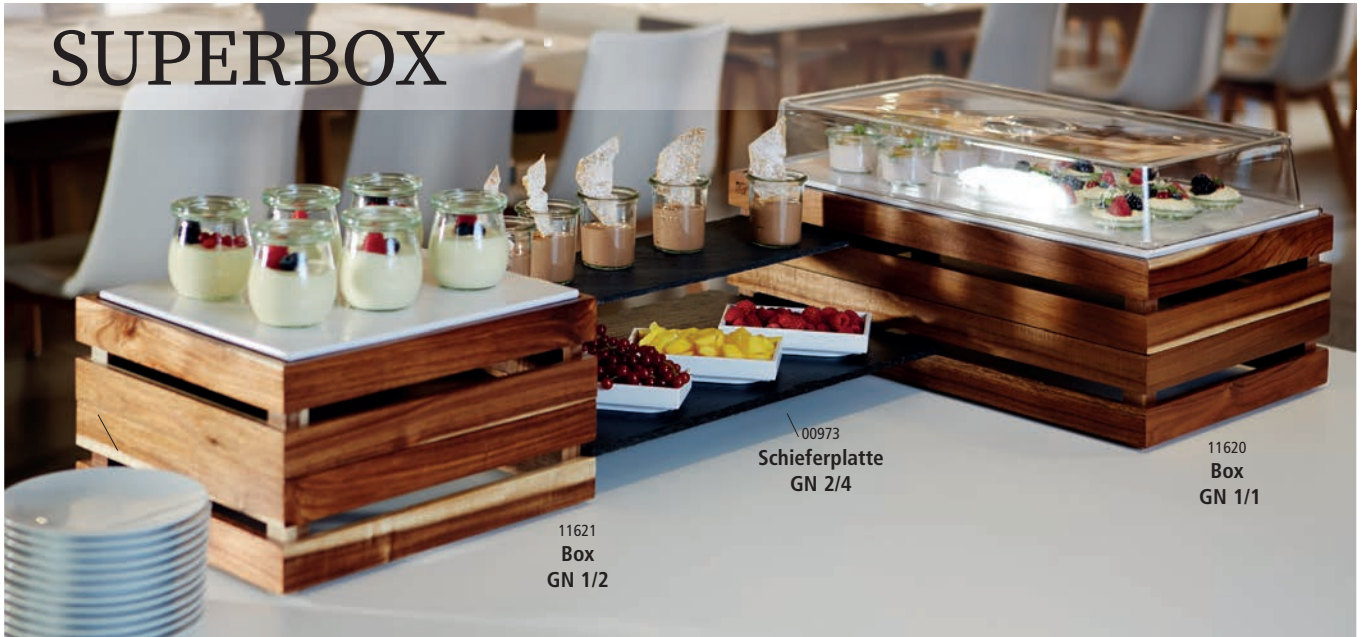

Die stapelbaren Wendeboxen lassen sich rutschfest stapeln und mit flachen GN Platten verbinden und einzeln nutzen. Individuell können Buffetlandschaften gebaut werden.

The stackable and non-slip reversible boxes can be connected to flat GN trays and can also be used individually. Different and individual buffet sceneries can be built up.

Las cajas girable y apilables son antideslizantes y se pueden conectar con bandejas planas GN o utilizar individualmente. Se pueden construir diferentes paisajes de buffet muy individuales.

Les boîtes de tournage empilables sont antiglissantes et peuvent être connectées avec des plateaux plats GN ou utilisées individuellement. Des paysages de buffet très personnalisés peuvent être construits.



## GN 1/1 „SUPERBOX“



Akazienholz / acacia wood / madera de acacia / bois d'acacia

	cm	↑ cm	Farbe / Colour
11620	55,5 x 35	10,5	
11626	55,5 x 35	10,5	



## GN 2/4 „SUPERBOX“



Akazienholz / acacia wood / madera de acacia / bois d'acacia

	cm	↑ cm	Farbe / Colour
11623	55,5 x 18,5	10,5	
11629	55,5 x 18,5	10,5	



## GN 1/2 „SUPERBOX“



Akazienholz / acacia wood / madera de acacia / bois d'acacia

	cm	↑ cm	Farbe / Colour
11621	35 x 29	10,5	
11627	35 x 29	10,5	



## GN 1/4 „SUPERBOX“



Akazienholz / acacia wood / madera de acacia / bois d'acacia

	cm	↑ cm	Farbe / Colour
11622	29 x 18,5	10,5	
11628	29 x 18,5	10,5	



GN „SUPERBOX VINTAGE“



Akazienholz  
 acacia wood  
 madera de acacia  
 bois d'acacia

	cm	↑ cm	GN	Farbe / Colour
11715	55,5 x 35,0	10,5	GN 1/1	■
11716	35,0 x 29,0	10,5	GN 1/2	■
11717	29,0 x 18,5	10,5	GN 1/4	■
11718	55,0 x 18,5	10,5	GN 2/4	■



Präsentationsmöglichkeit  
 presentation example



GN Naturschieferplatten



GN natural slate tray  
 GN bandeja de pizarra natural  
 GN plat ardoise naturelle

	cm	GN
00990	53,0 x 32,5	1/1
00991	32,5 x 26,5	1/2
00993	26,5 x 16,2	1/4
00973	53,0 x 16,2	2/4



GN Einsatz „SUPERBOX“



GN insert  
 GN bandeja  
 GN bac supérieur

	cm	↑ cm	GN	fits to
11616	53,0 x 32,5	8,5	GN 1/1	11620, 11626, 11700, 11715
11617	32,5 x 26,5	8,5	GN 1/2	11621, 11627, 11701, 11716



## Buffet & Display



### GN „SUPERBOX VINTAGE“



Leichtes Holz, Tannenholz

fir wood

madera de abeto

bois sapin

	cm	↑ cm	GN
11700	55,5 x 35,0	10,5	GN 1/1
11701	35,0 x 29,0	10,5	GN 1/2
11702	29,0 x 18,5	10,5	GN 1/4
11703	55,0 x 18,5	10,5	GN 2/4



### GN Tablett „ZERO“

GN tray  
GN bandeja  
GN plateau



	cm	↑ cm	GN	Farbe / Colour
84185	53,0 x 32,5	1,5	1/1	White
84195	53,0 x 32,5	1,5	1/1	Black
84186	32,5 x 26,5	1,5	1/2	White
84196	32,5 x 26,5	1,5	1/2	Black
84188	26,5 x 16,2	1,5	1/4	White
84198	26,5 x 16,2	1,5	1/4	Black
84189	53,0 x 16,2	1,5	2/4	White
84199	53,0 x 16,2	1,5	2/4	Black



mit Antirutschfüßchen  
with non-slip feet



### GN Naturschieferplatten

GN natural slate tray  
GN bandeja de pizarra natural  
GN plat ardoise naturelle



	cm	GN
00990	53,0 x 32,5	1/1
00991	32,5 x 26,5	1/2
00993	26,5 x 16,2	1/4
00973	53,0 x 16,2	2/4





Mit hohem Anspruch an Design und Funktionalität haben wir das Buffet-System „Bridge“ für Sie entwickelt. Die in den Holzoberflächen Ahorn und Wenge erhältlichen Artikel sind in ihren Höhen und ihren Volumina optimal aufeinander abgestimmt und gewährleisten einen einfachen und sicheren Umgang in Ihrem Gastronomiealltag.

The collection "Bridge" is bringing perfectly coordinated components for an uncomplicated and organized buffet system, finalizing in an unique buffet scenery. All pieces combine perfectly with one another in their variations of sizes and volumes. The wooden items are available in 2 colors, maple or wenge. A simple and safe handling is guaranteed.

Una colección universal para un buffet único: un Sistema funcional y fácil de componer, asociado a la elegancia de su exclusive diseño. Los elementos se combinan a la perfección entre variaciones de Alturas y volúmenes, realizando sus propuestas y composiciones culinarias y modelando el paisaje del buffet. Las piezas están disponibles en 2 colores, wengué o arce. Manejo sencillo y seguro.

Une collection universelle pour une présentation unique de votre buffet: fonctionnel et facile à composer, ce système est à la fois pratique, simple et spectaculaire par son élégant design. Les différents éléments se marient à la perfection pour construire sans difficulté différentes compositions, variant les hauteurs et les volumes et mettant en valeur vos créations culinaires. Les pièces sont disponibles en deux couleurs, bois wengué ou érable.



**Kühlbox „BRIDGE“**  
refrigerated buffet display  
set de buffet refrigerado  
présentoir buffet froid



Set bestehend aus: 1 Gestell aus Ahorn oder Wenge, 1 Behälter aus Kunststoff, 1 GN1/1 Tablett aus Melamin, 1 Kühlakku, 1 Rolltophaube (fix montiert)  
set consists of: 1 base element maple or wenge, 1 plastic insert black, 1 GN1/1 tray melamine, 1 cooler, 1 cover (fixed)

set compuesto por: 1 soporte de madera arce o wengué, 1 cubeta de plástico, 1 bandeja de melamina GN 1/1, 1 acumulador de frío, 1 campana rolltop (fija)

set composé de: 1 support en bois érable ou wengué, 1 bac plastique, 1 plat en mélamine GN 1/1, 1 accumulateur de froid, 1 cloche rolltop (fixe)

	cm	↑ cm	Farbe / Colour	
13990	63,5 x 42,5	31		ahorn wood
14990	63,5 x 42,5	31		wenge wood

## Buffet & Display



### Kühlschale „BRIDGE“

cooling bowl  
bol refrigerado  
bol réfrigéré



4-teilig: 1 Gestell aus Ahorn oder Wenge, 1 Behälter aus Edelstahl,  
1 Schale aus Melamin (Ø 14 cm o. 23 cm), 1 Kühlakku

4 pcs.: 1 base element maple or wenge, 1 bowl stainless steel,  
1 bowl melamine (Ø 14 o. 23 cm), 1 cooler

set de 4: 1 soporte de madera arce o wengué, 1 cuenco  
de acero inoxidable, 1 cuenco de melamina (ø 14 cm o 23 cm), 1 acumulador de frío

set de 4: 1 support en bois érable ou wengé, 1 bol en acier inox, 1 bol en mélamine  
(ø 14 cm ou 23 cm), 1 accumulateur de froid

	cm	↑ cm	ltr.	Farbe / Colour
13980	18,5 x 18,5	10	0,5	
13981	27,5 x 27,5	14	2,5	

	cm	↑ cm	ltr.	Farbe / Colour
14980	18,5 x 18,5	10	0,5	
14981	27,5 x 27,5	14	2,5	



### Edelstahlschale „BRIDGE“

stainless steel bowl  
cuenco acero inoxidable  
bol acier inoxydable



	Ø cm	↑ cm
30050	14	8,5
30052	23	13,5



### Schale „CASUAL MAXI“

bowl  
cuenco  
bol



	Ø cm	↑ cm	ltr.	Farbe / Colour
83700	14	6,5	0,5	
83702	23	10,5	2,5	

	Ø cm	↑ cm	ltr.	Farbe / Colour
83701	14	6,5	0,5	
83703	23	10,5	2,5	



### Frischhaltedeckel

airtight cover  
tapa hermética  
couvercle hermétique



	Ø cm
10890	14
10887	23

### Kühlakku / cooler / acumulador de frío / accumulateur de froid

	Ø cm	↑ cm
10661	10,5	2,5
10777	15,5	2,5



### Cerealispender „BRIDGE“

cereal dispenser  
dispensador de cereales  
distributeur de céréales



**Behälter herausnehmbar, „Feierabend-Deckel“ für das aromadichte Lagern, portionieren durch einfaches Drehen**

removable canister, special lid to keep the cereals fresh, easy to use, rotate the button to get the muesli

contenedor movible, tapa especial para mantener los cereales frescos, fácil de usar, se gira el pomo para servir los cereales

réceptif amovible, couvercle spécial pour conserver les céréales, usage facile en tournant le bouton

	cm	↑ cm	ltr.	Farbe / Colour	
13987	21 x 20	55,5	4,5		Ahorn / maple



### Saftdispenser „BRIDGE“

juice dispenser  
dispensador de zumo  
distributeur à jus



**Kühlung durch 2 Kühlakkus von oben und unten**

cooling with 2 cooling elements from the top and base

2 acum. de frío 1 en la base y 1 en la tapa

2 plaques de froid 1 dans le couvercle, 1 dans le socle

	cm	↑ cm	ltr.	Farbe / Colour	
10870	31,0 x 20	42	4		Ahorn / maple
10871	35,5 x 22	50	6		Ahorn / maple



### Besteckbehälter „BRIDGE“

cutlery organizer  
cajón para cubiertos  
bac à couverts



**2-teiliges Set: 1 Gestell, 1 Besteckbehälter (Nr. 11955), herausnehmbar**

2 pcs set: 1 base element, 1 removable plastic container (item 11955)

set de 2 piezas: 1 soporte + 1 cubeta extraíble 4 compartimentos de plástico (ref. 11955)

set de 2 pcs: 1 support + 1 bac plastique amovible à 4 compartiments (réf. 11955)

	cm	↑ cm	Farbe / Colour	
13995	57,5 x 37	12		Ahorn / maple



### Konferenzkühler „BRIDGE“

bottle cooler  
enfriador  
refraîchisseur



**2-teiliges Set, bestehend aus: 1 Gestell, 1 Behälter aus Edeldahl (doppelwandig)**

2 pcs set: 1 base element, 1 bowl stainless steel (double-wall)

set de 2 piezas: 1 soporte, champanera inox de doble pared

set de 2 pcs: 1 support, seau inox double paroi

	cm	↑ cm	Farbe / Colour	
13985	35 x 35	19		Ahorn / maple

## Buffet & Display



### Cerealispender „BRIDGE“

cereal dispenser  
dispensador de cereales  
distributeur de céréales



Behälter herausnehmbar, „Feierabend-Deckel“ für das aromadichte Lagern, portionieren durch einfaches Drehen

removable canister, special lid to keep the cereals fresh, easy to use, rotate the button to get the muesli

contenedor movable, tapa especial para mantener los cereales frescos, fácil de usar, se gira el pomo para servir los cereales

réceptif amovible, couvercle spécial pour conserver les céréales, usage facile en tournant le bouton

	cm	↑ cm	ltr.	Farbe / Colour	
14987	21 x 20	55,5	4,5		Wenge / wenge

inkl. 3 Magnetschilder:  
ORANGE, APPLE, GRAPEFRUIT



6 ltr.

10873

### Saftdispenser „BRIDGE“

juice dispenser  
dispensador de zumo  
distributeur à jus



Kühlung durch 2 Kühllakkus von oben und unten

cooling with 2 cooling elements from the top and base

2 acum. de frío 1 en la base y 1 en la tapa

2 plaques de froid 1 dans le couvercle, 1 dans le socle

	cm	↑ cm	ltr.	Farbe / Colour	
10872	31,0 x 20	42	4		Wenge / wenge
10873	35,5 x 22	50	6		Wenge / wenge



### Besteckbehälter „BRIDGE“

cutlery organizer  
cajón para cubiertos  
bac à couverts



2 teiliges Set: 1 Gestell, 1 Besteckbehälter (Nr. 11955), herausnehmbar

2 pcs set: 1 base element, 1 removable plastic container (item 11955)

set de 2: 1 soporte, 1 cajón para cubiertos (ref. 11955), extraíble

set de 2: 1 support, 1 bac à couverts (réf. 11955), amovible

	cm	↑ cm	Farbe / Colour	
14995	57,7 x 37	12		Wenge / wenge



### Flaschenkühler „BRIDGE“

bottle cooler  
enfriador  
refraîchisseur



2-teiliges Set, bestehend aus: 1 Gestell, 1 Behälter aus Edelstahl (doppelwandig)

2 pcs set: 1 base element, 1 bowl stainless steel (double-wall)

set de 2: 1 soporte, 1 cuenco de acero inoxidable (doble pared)

set de 2: 1 support, 1 bol en acier inox (double paroid)

	cm	↑ cm	Farbe / Colour	
14985	35 x 35	19		Wenge / wenge

# PROFI LINE



## GN Edelstahl-Tablett „PROFI LINE“

GN tray  
GN bandeja  
GN plat empilable système catering



	cm	↑ cm	GN	
11100	53,0 x 32,5	1,5	1/1	mit glattem Rand / without decor-edge sin borde decorado / bords lisses
12100	32,5 x 26,5	1,5	1/2	mit glattem Rand / without decor-edge sin borde decorado / bords lisses
11000	53,0 x 32,5	1,5	1/1	mit Dekor-Rand / with decor-edge con borde decorado / bords avec relief
12000	32,5 x 26,5	1,5	1/2	mit Dekor-Rand / with decor-edge con borde decorado / bords avec relief
11110	53,0 x 32,5	1,0	1/1	glatter schmaler Rand / smooth narrow edge / borde estrecho liso / bord étroit lisse



## Fleisch- und Gemüseplatte „PROFI LINE“

tray  
fuente de servicio  
plat de service

Dekorrand hochglanzpoliert  
decor edge mirror polished finish  
borde decorado pulido efecto espejo  
contour relief avec effet miroir



	Ø cm	↑ cm
11032	32	2,6
11038	38	2,6
11048	48	2,6



## Fleisch- und Gemüseplatte „PROFI LINE“

tray  
fuente de servicio  
plat de service

Dekorrand hochglanzpoliert  
decor edge mirror polished finish  
borde decorado pulido efecto espejo  
contour relief avec effet miroir



	cm	↑ cm
11023	50 x 36	2,6
11024	60 x 41	2,6
11025	70 x 46	2,6

## Buffet & Display



### GN Edelstahl-Behälter „PROFI LINE“

GN pan  
GN cubeta  
GN bac



	cm	↑ cm	GN	litr.
11020	53,0 x 32,5	2,0	1/1	1,7
11040	53,0 x 32,5	4,0	1/1	3,4
11065	53,0 x 32,5	6,5	1/1	7,0
12040	32,5 x 26,5	4,0	1/2	2,0
12065	32,5 x 26,5	6,5	1/2	3,3



### GN 1/1 System-Tablett „PROFI LINE“

GN 1/1 tray  
GN 1/1 bandeja  
GN 1/1 plateau



Dekorrand hochglanzpoliert, massive Griffe verchromt,  
inkl. fest verschraubten Distanzstücken, Nutzhöhe 4 cm

decor edge mirror polished finish, chrome plated handles,  
incl. mounted 4 cm distance pillars

borde decorado pulido brillante, asas cromadas,  
incl. distanciadores atornillados, con  
profundidad efectiva de 4 cm

bord avec reliefs poli miroir, poignées chromées,  
incl. distance bien fixée avec hauteur utile de 4 cm

	cm	GN
11300	53 x 32,5	1/1



### GN 1/1 System-Tablett „PROFI LINE“

GN 1/1 tray  
GN 1/1 bandeja  
GN 1/1 plateau



Rand hochglanzpoliert, massive Bügelgriffe vergoldet, inkl.  
fest verschraubten Distanzstücken, Nutzhöhe 4 cm

mirror polished finish edge, gold plated handles,  
stackable approx. 4 cm

borde pulido brillante, asas doradas, incl. distanciadores atornillados,  
con profundidad efectiva de 4 cm

bord poli miroir, poignées dorées, incl. distance bien fixée  
avec hauteur utile de 4 cm

	cm	GN
11290	53 x 32,5	1/1



### GN 1/1 System-Tablett „BUFFET-STAR“

GN 1/1 tray  
GN 1/1 bandeja  
GN 1/1 plateau



Rand hochglanzpoliert, inkl. fest verschraubten Griffen inkl. Distanzstücken, Nutzhöhe 4 cm

mirror polished finish edge, incl. screwed handles incl. distance pillars, 4 cm distance

borde pulido brillante, incl. asas atornillables, incl. distanciadores  
con profundidad efectiva de 4 cm

bord poli miroir, incl. poignées à visser, incl. distance avec hauteur utile de 4 cm

	cm	GN	
11150	53 x 32,5	1/1	mit verchromten Griffen / with chrome plated handles / con asas cromadas / avec poignées chromées
11155	53 x 32,5	1/1	mit vergoldeten Griffen / with gold plated handles / con asas doradas / avec poignées dorées



### System-Tablett „BUFFET-STAR“

system tray  
bandeja del sistema  
plat empilable système catering



Rand hochglanzpoliert, inkl. fest verschraubten Griffen inkl. Distanzstücken, Nutzhöhe 4 cm  
mirror polished finish edge, incl. screwed handles incl. distance pillars, 4 cm distance  
borde pulido efecto espejo, incluye asas atornillables, distanciadores a 4 cm  
contour effet miroir, poignées à visser, distance approx. 4 cm

	Ø cm	
11160	48	mit verchromten Griffen / with chrome handles
11165	48	mit vergoldeten Griffen / gold plated handles

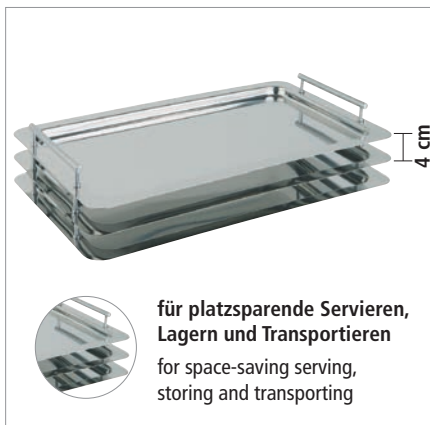

### GN 1/1 System-Tablett „CLASSIC“

GN tray  
GN bandeja  
GN plat empilable système catering



Rand hochglanzpoliert, mit fest verschraubten Griffen inkl. Distanzstücken, Nutzhöhe 4 cm  
mirror polished finish edge, incl. screwed handles incl. distance pillars, 4 cm distance  
borde pulido efecto espejo, incluye asas atornillables, distanciadores a 4 cm  
contour effet miroir, poignées à visser, distance approx. 4 cm

	cm	GN
11295	53 x 32,5	1/1



### Tablett „SWING“

tray  
bandeja  
plateau



Rand matt poliert, innen hochglanzpoliert  
satin polished finish edge, inside mirror polished finish  
borde pulido efecto satinado, interior pulido efecto espejo  
contour effet mat, intérieur poli miroir

	cm	↑ cm	GN
01415	28,5 x 20,0	1	
01416	32,5 x 32,5	1	
01420	53,0 x 32,5	1	1/1



### Tablett „SUNDAY“

tray  
bandeja  
plateau



hochglanzpoliert  
mirror polished finish  
acabado espejo pulido  
effet brillant

	cm	↑ cm	GN
11210	32,5 x 26,5	2	1/2
11220	53,0 x 32,5	2	1/1

## Buffet & Display



### GN 1/1 Buffet-Set „CATERER“

GN 1/1 buffet set  
GN 1/1 set de bufé  
GN 1/1 set catering: plateau + cloche



2-teilig: Tablett + Haube, Tablett fixiert sich auf der Haube - kein Rutschen möglich  
2 pcs. set: tray + cover, tray fixes itself on the cover and can not slip off  
set de 2: bandeja + tapa, la bandeja encaja encima de la tapa para que no se deslice  
set de 2: plateau GN 1/1 réf. + cloche spéciale empilement stable

	cm	↑ cm	GN
11195	53 x 32,5	10,5	1/1



### GN 1/1 Buffet-Set „HOCHSTAPLER“

GN 1/1 buffet set  
GN 1/1 set de bufé  
GN 1/1 kit catering plateau + cloche



2-teilig: Tablett + Haube, Tablett fixiert sich auf der Haube - kein Rutschen möglich  
2 pcs. set: tray + cover, tray fixes itself on the cover and can not slip off  
set de 2: bandeja + tapa, la bandeja encaja encima de la tapa para que no se deslice  
set de 2: plateau GN 1/1 réf. + cloche spéciale empilement stable

	cm	↑ cm	GN
11302	53 x 32,5	10,5	1/1



### GN 1/1 Haube „HOCHSTAPLER“

GN 1/1 cover  
GN 1/1 campana  
GN 1/1 cloche



glasklarer Kunststoff, Tablett fixiert sich auf der Haube - kein Rutschen möglich, nahezu bruchfest

clear plastic, tray fixes itself on the cover and can not slip off, nearly unbreakable

plástico transparente, la bandeja se fija a la tapa para que no se deslice, muy resistente a la rotura

en plastique transparent, le plat se fixe sur le dessous de la cloche pour ne pas glisser, très résistant à la casse

	cm	↑ cm	fits to	GN
11305	53 x 32,5	9	11300, 11290, 11295	1/1



### GN Abdeckhaube

GN cover  
GN cubierta  
GN cloche



	cm	↑ cm	✱ mm	GN
11041	32,5 x 26,5	9,5	3	1/2
11042	53,0 x 32,5	9,5	3	1/1
11043	32,5 x 17,6	10,5	3	1/3
11044	53,0 x 16,2	10,5	3	2/4





00382

Tablett „SCHÖNER ESSEN“

tray  
bandeja  
plateau



cm		
00383	35,0 x 24,0	
00382	42,0 x 31,0	
00381	50,0 x 36,0	
00384	63,5 x 44,5	
00385	60,0 x 40,0	
cm		
03824	42,0 x 31,0	leichte Ausführung 0,5 mm / extra light model 0,5 mm modelo extraligero 0,5 mm / qualité légère, ép. 0,5 mm
03814	50,0 x 36,0	leichte Ausführung 0,5 mm / extra light model 0,5 mm modelo extraligero 0,5 mm / qualité légère, ép. 0,5 mm



GN 1/1

GN 1/1 Tablett „SCHÖNER ESSEN“

GN tray  
GN bandeja  
GN plateau



cm	GN
00388	53,0 x 32,5 / 1/1



00081

Tablett „SCHÖNER ESSEN“

tray  
bandeja  
plateau



mit Dekorrand, Griffe Zinkdruckguss verchromt, genietet  
with decor edge, handles zinc alloy chrome plated, riveted  
borde decorado, asas fundición con zinc  
bord décor, poignées en fonte zinguée

cm		
00082	52 x 31,0	
00081	60 x 36,0	
00084	75 x 44,5	



Tablett „SCHÖNER ESSEN“

tray  
bandeja  
plateau



cm		
00087	38 x 23	rechteckig, abgerundet / rectangular, rounded edge rectangular / rectangulaire



oval

Tablett „SCHÖNER ESSEN“

tray  
bandeja  
plateau



cm		
00089	50 x 39,5	

## Buffet & Display



### Tablett „SCHÖNER ESSEN“

tray  
bandeja  
plateau



	Ø cm	
00075	31	
00085	35	



### Tablett mit Haube „SCHÖNER ESSEN“

tray with cover  
bandeja con cubierta  
plateau avec cloche



	cm	↑ cm
38202	42 x 31	8

Haube / cover / campana / cloche

	cm	↑ cm
08201	36,5 x 26,0	7,5



### GN 1/1 Tablett „STAR“

GN tray  
GN bandeja  
GN plateau



Rand hochglanzpoliert mit Prägung

polished decor edge  
borde pulido decorado  
bords polis miroir, avec relief sur les petits côtés

	cm	GN
11115	53 x 32,5	1/1



**griffig, keine Fingerabdrücke sichtbar, Randprägung auf kurzen Seiten**  
catchy, fingerprints are not visible, edge lettering on the short sides



### GN 1/1 Buffet-Tablett „HALBMOND“

GN tray  
GN bandeja  
GN plat demi-lune



mit klassischem Linienpräggedekor, passend für Thermoboxen GN 1/1 und Thermoporte

with decor edge, usable in thermoboxes GN 1/1  
con borde decorado, apto para cajas térmicas GN 1/1  
bords avec relief, apte pour conteneurs GN 1/1

	cm	GN
11111	53 x 32,5	1/1



### Edelstahl-Schale

bowl  
bandeja ovalada inox  
corbeille ovale inox



eingerollter Rand

rolled edge  
borde redondeado  
bord roulé

	cm	↑ cm
40110	26,5 x 18,5	4,0
40115	31,0 x 21,0	4,5



**Tablett**

tray  
bandeja  
plateau

mit gebördeltem, polierten Rand  
rolled and mirror polished edge  
borde redondeado acabado efecto espejo  
bord rond, effet miroir



	Ø cm	↑ cm
01336	35	3



**Buffetständer**

buffet stand  
soporte buffet  
support buffet



	Ø cm	↑ cm	fits to
74207	20 - 25	19	01336



Ø 19 cm - Ø 28 cm - Ø 40 cm

**Servierpfanne**

pan  
fuente para la mesa  
plat pour la table

mit vergoldeten Edelstahl-Griffen, 1 mm dick  
with gold plated handles, 1 mm thickness  
grosor 1 mm., asas doradas  
épaisseur 1 mm, poignées dorées



	cm	↑ cm	ltr.
61190	19	3,5	0,7
61280	28	4,0	2,0
61400	40	5,0	4,5



**Servierpfanne**

pan  
fuente para la mesa  
plat pour la table

mit vergoldeten Edelstahl-Griffen, 1 mm dick  
with gold plated handles, 1 mm thickness  
grosor 1 mm., asas doradas  
épaisseur 1 mm, poignées dorées



	cm	↑ cm	ltr.
60270	26,5 x 19,5	3	0,8
60310	31,0 x 21,5	3	1,2



Tablett „FINESSE“

tray  
bandeja  
plateau



cm

01314	30 x 24
01313	35 x 24
01317	39 x 26
01312	42 x 31
01318	48 x 30
01311	50 x 38
01310	58 x 42
01309	68 x 48



Tablett „FINESSE“

tray  
bandeja  
plateau



Ø cm

01332	32,0
01335	35,0
01338	38,0
01348	48,0
01349	48,5
01358	58,0



Tablett „FINESSE“

tray  
bandeja  
plateau



cm

01322	42 x 30
01323	50 x 36
01324	60 x 41
01325	70 x 46



Tablett „FINESSE“

tray  
bandeja  
plateau



verchromte Messing-Griffe  
chrome plated brass handles  
asas plateadas de latón  
poignées en laiton chromées

Ø cm

01738	38
01748	48



**Tablett „FINESSE“**

tray  
bandeja  
plateau

verchromte Messing-Griffe  
chrome plated brass handles  
asas de latón cromadas  
poignées en laiton chromées



	cm	
01712	44 x 31	
01711	52 x 38	
01710	60 x 42	
01709	70 x 48	



**Tablett mit Haube „FINESSE“**

tray with cover  
bandeja con campana  
plateau avec cloche



	cm		↑ cm
13122	42 x 31		8,5



**Tablett mit Haube „FINESSE“**

tray with cover  
bandeja con campana  
plateau avec cloche



	Ø cm	↑ cm
13622	22	9,5



**Tablett mit Haube „FINESSE“**

tray with cover  
bandeja con cubierta  
plateau avec cloche



	Ø cm	↑ cm	Ø cm Hauben / cover
13382	38	12	30
13385	38	13	33



**Edelstahltablett**

tray  
bandeja  
plateau



	cm		↑ cm
09010	43,5 x 32,5		1,5

**Rolltophaube „PURE“ / rolltop cover / campana abatible / cloche basculante**

	cm		↑ cm
09013	44 x 33,5		17

## Buffet & Display



### Tablett „ELEGANCE“

tray  
bandeja  
plateau



	cm
02310	41 x 26
02311	48 x 30
02312	60 x 37



### Tablett mit Haube „ELEGANCE“

tray with cover  
bandeja con cubierta  
plateau avec cloche



	cm	↑ cm
23642	35 x 19	10



### Serviertablett mit Haube

tray  
bandeja  
plateau



	cm	↑ cm
00064	33 x 17	10
00067	25 x 19	7

Haube für 00064 / cover for 00064 / campana para 00064 / cloche pour 00064

06401

Haube für 00067 / cover for 00067 / campana para 00067 / cloche pour 00067

06701



### Tortenplatte mit Haube

cake plate with cover  
bandeja tarta con campana  
plat à tarte avec cloche



	Ø cm	↑ cm	
00065	30	11	mit 1 Haube / with 1 cover
00652	30	7 + 11	mit 2 Hauben / with 2 cover



### Tortenplatte „BAROCK“

cake plate  
bandeja tartas  
plat à gâteau



2-teilig: Tortenplatte mit Barock-Rand + Haube (extra stabil)

2 pcs. set: cake plate with decor edge „Barok“ + cover (extra robust)

set de 2: porta tartas, borde decor „Barok“ + campana (extra fuerte)

set de 2: plateau bord décor „Barok“ + cloche ultra-résistante

	Ø cm	↑ cm
06503	32	10

Frischhalte-Haube / cover / campana / cloche

	Ø cm	↑ cm
06510	30	11,5



**Käseglocken-Set „BRAZIL“**

rolltop set  
set rolltop  
set cloche á fromage



**3-teilig: Tablett + Holzschneidebrett + Rolltophaube glasklar, rutschfeste Haubenfixierung**

3 pcs. set: tray + wooden board + rolltop cover, cover non-slip fixed  
set de 3: bandeja + tablero de madera + campana abatible, fijación antideslizante  
set de 3: plateau + planche à découper + cloche abattante, fixation antiglisse

	Ø cm	↑ cm
09085	45	24



Ø 38 cm / 50 cm

**Rolltop-Set**

rolltop set  
set rolltop  
set cloche à fromage



**2-teilig: Tablett + Rolltophaube glasklar, rutschfeste Haubenfixierung, klappbar**

2 pcs. set: tray + rolltop cover, cover non-slip fixed, mountable  
set de 2: bandeja + campana abatible fijación antideslizante, montable  
set de 2: plateau + cloche abattante, fixation antiglisse, montable

	Ø cm	↑ cm
09080	38	24
09099	50	28



**Rolltop-Set**

rolltop set  
set rolltop  
set rolltop



**2-teilig: Schneidbrett marmoriert + Rolltophaube glasklar, rutschfeste Haubenfixierung, klappbar**

2 pcs. set: plastic board + rolltop cover, cover non-slip fixed, mountable  
set de 2: tablero de plástico + tapa abatible, tapa antideslizante, montable  
set de 2: planche à découper + cloche abattante, fixation antiglisse, montable

	Ø cm	↑ cm
09081	38	24



**Rolltop-Set, 3-teilig**

rolltop set, 3 pcs.  
rolltop, set de 3  
rolltop, set de 3



**1 Edelfولاذtablett Ø 38 cm + 1 Naturschieferplatte Ø 33 cm + 1 Rolltophaube Ø 38 cm**

1 stainless tray Ø 38 cm + 1 natural slate tray Ø 33 cm + 1 rolltop cover Ø 38 cm  
1 bandeja de acero inoxidable Ø 38 cm + 1 bandeja de pizarra natural Ø 33 cm + 1 tapa abatible Ø 38 cm  
1 plat inox 38 cm + 1 plat ardoise naturelle 33 cm + 1 cloche 38 cm

	Ø cm	↑ cm
01000	38	24



**Buffet-Set, 2-teilig**

buffet set, 2 pcs.  
set de bufé, set de 2  
présentoir pour le buffet, set de 2



**1 Platte + 1 Rolltophaube, schneidfeste und porenfreie Oberfläche, rutschfeste Haubenfixierung, Platte mit rutschfesten Füßen**

2 pcs. set: glass board + rolltop cover, scratch-resistant surface, cover non-slip fixed, non-slip feet  
set de 2: bandeja vidrio redonda + campana abatible, fijación antideslizante, pies antideslizantes  
set de 2: plateau verre rond + cloche abattante, fixation antiglisse et pieds antidérapants

	Ø cm	↑ cm
00978	38	23

# PARTYPLATTEN

Nicht säure- und spülmaschinenfest, Lebensmittel nur mit Papierdeckchenunterlage servieren.

Non-acid and dishwasher-proof, serve food only with paper tray covers.

No resistente a los ácidos y al lavavajillas, servir alimentos sólo con papel para bandeja party.

Pas résistant aux acides et au lave-vaisselle, servent la nourriture seulement avec papier dentelles.



## Warenträger

display  
expositor  
présentoir

für Partyplatten

- platzsparende flexible Präsentation durch geringe Abmessungen
- als Zweitplatzierung für Ihre zusätzlichen Umsätze
- in weiß lieferbar

for partytrays- space saving presentation- small size- available in white  
para bandejas Party, ocupa poco espacio, disponible en blanco  
pour plateaux Party, occupe très peu d'espace, disponible en blanc

	cm	↑ cm
00397	55 x 65	190



## Partyplatte „CLASSIC“

partytray  
bandeja party  
plateau party



mit Liniendekor, Rand eingerollt

with line decor, rolled edge  
con filos en relieve  
avec décoration lignée, bord rond

	Ø cm	VE / unit
00396	35	48



## Partyplatte „CLASSIC“

partytray  
bandeja party  
plateau party



mit Liniendekor, Rand eingerollt

with line decor, rolled edge  
con filos en relieve  
avec décoration lignée, bord rond

	cm	VE / unit
00398	46 x 34	48



## Partyplatte „CLASSIC“

partytray  
bandeja party  
plateau party



mit Liniendekor, Rand eingerollt

with line decor, rolled edge  
con filos en relieve  
avec décoration lignée, bord rond

	cm	VE / unit	GN
00395	53,0 x 32,5	36	1/1
00399	41,0 x 31,0	48	
00389	35,4 x 32,5	48	2/3



hot price



**Partyplatte**

partytray  
bandeja party  
plateau party



**Innenfläche ziseliert, Rand eingerollt**

rolled edge, decorated surface

borde redondeado, superficie totalmente decorada

bord rond, surface entièrement ciselée

	Ø cm	VE / unit
00393	35	48

hot price



oval

**Partyplatte**

partytray  
bandeja party  
plateau party



**Innenfläche ziseliert, Rand eingerollt**

rolled edge, decorated surface

borde redondeado, superficie totalmente decorada

bord rond, surface entièrement ciselée

	cm	VE / unit
00391	46 x 34	48

hot price



**Partyplatte**

partytray  
bandeja party  
plateau party



**Innenfläche ziseliert, Rand eingerollt**

rolled edge, decorated surface

borde redondeado, superficie totalmente decorada

bord rond, surface entièrement ciselée

	cm	VE / unit
00392	41 x 31	48

hot price



GN 1/1

**GN 1/1 Partyplatte**

GN partytray  
GN bandeja party  
GN plateau party



**Innenfläche ziseliert, Rand eingerollt**

rolled edge, decorated surface

borde redondeado, superficie totalmente decorada

bord rond, surface entièrement ciselée

	cm	VE / unit	GN
00394	53 x 32,5	36	1/1

## Buffet & Display



### Serviertöpfchen

small serving pot  
olla pequeña de servir  
marmite petite de servir



gehämmerte Oberfläche  
hammered surface  
superficie martillada  
surface martelée

	Ø cm	↑ cm	ltr.	Griff
40186	9,5	5,5	0,30	2,5
40187	13,5	5,0	0,55	3,0
40188	15,5	5,0	0,75	3,0



### Kaviarkühler

caviar cooler  
enfriador de caviar  
rafraîchisseur de caviar



4-teilig: 1 Edelstahlschale, 1 Halter, 1 Glashalm, 1 Edelstahldeckel

4 pcs.: 1 stainless steel bowl, 1 holder, 1 glass bowl Ø 10 cm, 1 stainless steel cover

set de 4: 1 bol de acero inoxidable, 1 soporte, 1 bol de vidrio Ø 10 cm, 1 tapa de acero inoxidable

set de 4: 1 bol en acier inox, 1 support, 1 bol en verre Ø 10 cm, couvercle en acierinox

	Ø cm	↑ cm
01699	18	12



### Serviertablett „KAFFEEHAUS“

tray  
bandeja  
plateau



matt poliert  
satin polished finish

matt poliert, oval, Rand ingerollt

satin polished finish, oval, rolled edge

pulido acabado efecto satinado, oval, borde redondeado

effet satin, ovale, bord rond

	cm	↑ cm	
30111	19,0 x 15,0	1	für Zucker und Sahne / for sugar and cream
30112	26,5 x 19,0	1	für eine Tasse / for one cup
30113	29,0 x 22,0	1	für zwei Tassen / for two cups
30123	23,0 x 17,5	1	für zwei Tassen / for two cups



### Serviertablett „KAFFEEHAUS“

tray  
bandeja  
plateau



hochglanzpoliert  
mirror polished finish

hochglanzpoliert, oval, Rand ingerollt

mirror polished finish, oval, rolled edge

pulido efecto espejo, ovalado, borde redondeado

effet brillant, ovale, bord rond

	cm	↑ cm	
30115	19,0 x 15	1	für Zucker und Sahne / for sugar and cream para azúcar y crema / pour le sucre et la crème
30116	26,5 x 19	1	für eine Tasse / for one cup para una taza / pour une tasse
30117	29,0 x 22	1	für zwei Tassen / for two cups para dos tazas / pour deux tasses



Serviertablett „KAFFEEHAUS“

tray  
bandeja  
plateau

**matt poliert, Rand eingerollt**  
satin polished finish, rolled edge  
acabado pulido satinado, borde redondeado  
effet satin mat, bord rond



	cm	↑ cm
30118	21,5 x 13	1,5
30119	23,0 x 23	1,5
30120	20,0 x 11	1,5
30121	29,0 x 20	1,5



**mattiert**  
satin polished finish

Serviertablett „KAFFEEHAUS“

tray  
bandeja  
plateau

**mattiert / satin polished finish**  
acabado efecto satinado / fini mat effet satin



	cm	↑ cm	
30126	25,5 x 19,5	2	mattiert / satin polished finish acabado efecto satinado / fini mat effet satin



84253

Serviertablett „KAFFEEHAUS“

tray  
bandeja  
plateau

Farbe / Colour



	cm	↑ cm	Farbe / Colour
84251	26,0 x 20,0	1,5	■
84253	28,5 x 21,5	1,5	■



hot price

Serviertablett „KAFFEEHAUS“

tray  
bandeja  
plateau

**Innenfläche ziseliert, Rand eingerollt**  
rolled edge  
borde redondeado, superficie decor relieve  
bord rond, surface entièrement ciselée



	cm	pcs.
30114	30 x 22	48

NEW



30130



30131



30132



30132



30133



30133

Tablett „VINTAGE“

tray  
bandeja  
plateau



Edelstahl-Look vintage  
stainless steel vintage look  
acero inoxidable look vintage  
acier inox look vintage

	cm	↑ cm
30130	26,0 x 13,5	1,5
30131	34,0 x 18,0	1,5
30132	38,0 x 26,5	1,5
30133	25,5 x 16,0	3,0

passende Schälchen / fitting bowls / cuencos adecuados / bols apropiés



	Ø cm	↑ cm	ltr.
40655	7,5	5,5	0,17
40656	7,5	10,0	0,35



S. 276  
page 276



30130



30132

Servierbeispiel  
presentation example

Tablett „TREND“

baking sheet  
bandeja  
plateau



ein Backblech wird zum Serviertablett  
a baking sheet which becomes a serving tray  
una bandeja de hornear que se convierte en una bandeja de servir  
un moule qui devient un plateau de service

	cm	↑ cm
13380	32 x 21,5	2





**Servier- und Tortenplatte „ACACIA MINI“**

cake stand  
porta pasteles  
présentoir à gâteaux

Akazienholz geölt  
acacia wood oiled  
madera de acacia aceitada  
bois d'acacia huilé



	Ø cm	↑ cm
33290	9,5	7
33291	13,0	9



**Servier- und Tortenplatte „ACACIA“**

cake stand  
porta pasteles  
présentoir à gâteaux

Akazienholz geölt  
acacia wood oiled  
madera de acacia aceitada  
bois d'acacia huilé



	Ø cm	↑ cm
33292	24,0	8
33293	24,0	16
33294	33,0	8
33295	33,0	16
33296	38,5	8
33297	38,5	16



**Frischhalte- Haube / cover / campana / cloche**



	Ø cm	↑ cm	fits to
06519	21	17	33292, 33293
06520	30	22	33294, 33295
06521	36	27	33296, 33297

**NEW CLASSIC**

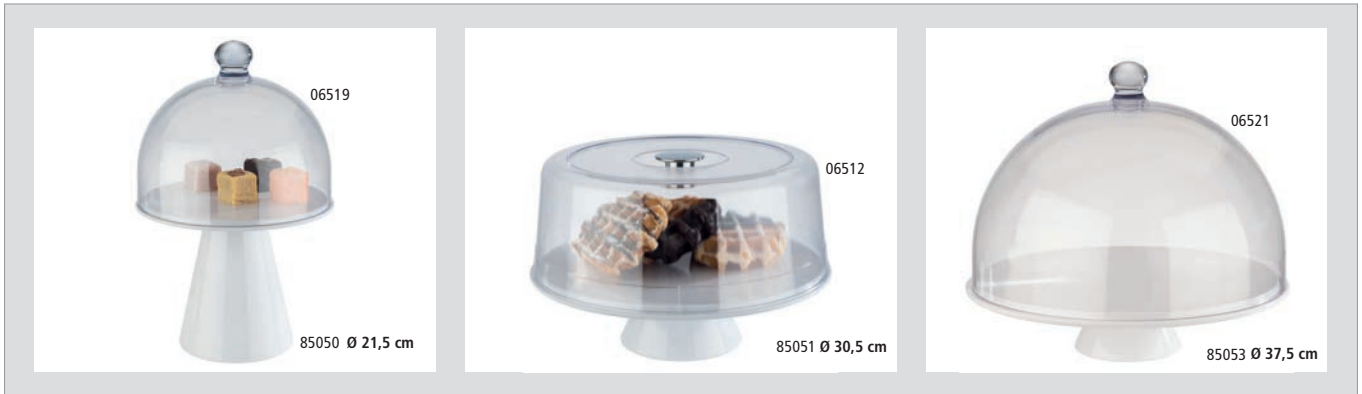

**Servier- und Tortenplatte „CLASSIC“**

cake stand  
porta pasteles  
présentoir à gâteaux



**Rand fixiert die Haube**  
carved edge fixes the cover  
ranura para fijar bien la campana  
bord rainuré pour maintenir ferme la cloche

	Ø cm	↑ cm
85049	21,5	9
85050	21,5	17
85051	30,5	9
85052	30,5	17
85053	37,5	9
85054	37,5	17

**Frischhalte- Haube / cover / campana / cloche**



	Ø cm	↑ cm	fits to
06519 <b>NEW</b>	21	17	85049, 85050
06520	30	22	85051, 85052
06521 <b>NEW</b>	36	27	85053, 85054

**Frischhalte- Haube / cover / campana / cloche**



	Ø cm	↑ cm	fits to
06512	30	11,5	85051, 85052



**Konditorplatte**  
 cake stand  
 soporte para pastel  
 présentoir à gâteaux



**matt poliert**  
 satin polished finish  
 acabado efecto satinado  
 poli mat effet satin

	Ø cm	↑ cm
00046	31	3



**Servier- / Tortenplatte**  
 cake stand  
 soporte para pastel  
 présentoir à gâteaux



**Fuß hochglanzpoliert, Platte matt poliert, stabil und sehr standsicher**  
 foot mirror polished finish, plate satin polished finish  
 pie pulido brillante, bandeja pulida mate  
 pied brillant, plateau poli satin mat

	Ø cm	↑ cm
00462	30	11



**Servier- / Tortenplatte**  
 cake stand  
 soporte para pastel  
 présentoir à gâteaux



**matt poliert, drehbar, möbelschonende Moosgummi-Unterseite**  
 satin polished finish, rotating, foam rubber below to save your furniture  
 acabado pulido satinado, giratorio, base revestida de goma para no rallar el mobiliario  
 poli satiné, plateau tournant, revêtement mousse sous le pied pour ne pas rayer les meubles

	Ø cm	↑ cm
00463	30,5	9



**Servier- / Tortenplatte**  
 cake stand  
 soporte para pastel  
 présentoir à gâteaux



**Fuß matt poliert, stabil und sehr standsicher, möbelschonende Moosgummi-Unterseite**  
 foot satin polished finish, foam rubber below to save your furniture  
 pie pulido con efecto satinado, base revestida de goma para no rallar el mobiliario  
 inox poli satin, revêtement mousse sous le pied pour ne pas rayer les meubles

	Ø cm	↑ cm
00464	30	11

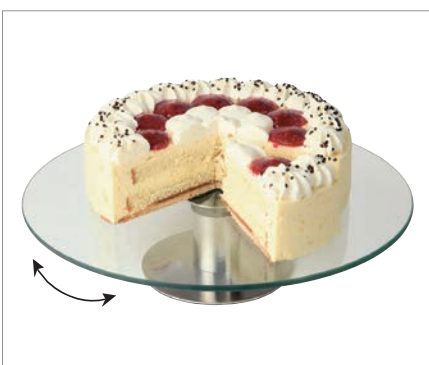

**Servier- / Tortenplatte**  
 cake stand  
 soporte para pastel  
 présentoir à gâteaux



**Fuß matt poliert, drehbar, möbelschonende Moosgummi-Unterseite**  
 foot satin polished finish, rotating, foam rubber below to save your furniture  
 vidrio, pie inox satinado giratorio, base de goma para proteger el mobiliario  
 plateau en verre, pied tournant inox poli satin, revêtement mousse sous le pied anti-rayures

	Ø cm	↑ cm
00444	30	7

## Buffet & Display

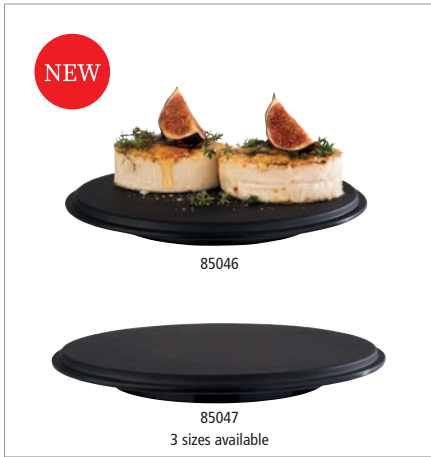

### Torten- / Konditorplatte „SLATE“

cake stand  
soporte para pastel  
présentoir à gâteaux



Rand fixiert die Haube, mit Antirutsch-Füßchen, Schiefer Look  
carved edge fixes the cover, with non-slip feet, slate look  
ranura para fijar bien la campana, con pies antideslizantes, aspecto pizarra  
bord rainuré pour maintenir ferme la cloche, avec pieds antidérapants, aspect ardoise



	Ø cm	↑ cm	passende Haube / suitable cover / campana adecuada / cloche appropriée
85046	21,5	2,5	06519 <b>NEW</b>
85047	30,5	3,5	06520, 06512, 6510
85048	37,5	4,0	06521 <b>NEW</b>



### Torten- / Konditorplatte „LOOPS“

cake stand  
soporte para pastel  
présentoir à gâteaux



	Ø cm	↑ cm	passende Haube / suitable cover / campana adecuada / cloche appropriée
85033	21,5	2,5	06519 <b>NEW</b>
85034	30,5	3,5	06520, 06512, 06510
85035	37,5	4,0	06521 <b>NEW</b>

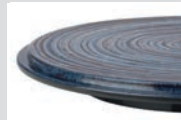

Rand fixiert die Haube, mit Antirutsch-Füßchen  
carved edge fixes the cover, with non-slip feet



### Torten- / Konditorplatte

cake stand  
soporte para pastel  
présentoir à gâteaux



Rand fixiert die Haube, mit Antirutsch-Füßchen  
carved edge fixes the cover, with non-slip feet  
ranura para fijar bien la campana, con pies antideslizantes  
bord rainuré pour maintenir ferme la cloche, avec pieds antidérapants



	Ø cm	↑ cm	Farbe / Colour	fits to
00468	31	3,5	■	06520
00469	31	3,5	■	06520



### Servier- und Tortenplatte „CASUAL“

cake plate  
porta pasteles  
présentoir à gâteaux



	Ø cm	↑ cm
83890	31	8
83891	31	16



### Servier- und Tortenplatte „CASUAL“

cake plate  
porta pasteles  
présentoir à gâteaux



	cm	↑ cm
83892	31 x 31	8
83893	31 x 31	16



# Naturschiefer



VERSIEGELT  
SEALED  
**PREMIUM  
QUALITY**  
EXTRA STARK  
STRONG



00990  
GN 1/1

00991  
GN 1/2

00992  
GN 1/3

00993  
GN 1/4

## GN Naturschieferplatten

GN natural slate tray  
GN bandeja de pizarra natural  
GN plat ardoise naturelle



hervorragende Kältespeicherung durch Naturschiefer, die Kanten der Platten sind gebrochen und nicht gesägt  
excellent coldness store, food safe, waterproof  
excelente conservador del frio, para reforzar la estética natural, los bordes ofrecen un canto irregular  
excellent maintien du froid, les bords sont volontairement cassés pour renforcer l'esthétique naturelle

	cm	✱ mm	GN
00990	53,0 x 32,5	6 - 9	1/1
00991	32,5 x 26,5	6 - 9	1/2
00992	32,5 x 17,6	6 - 9	1/3
00993	26,5 x 16,2	6 - 9	1/4
00973	53,0 x 16,2	6 - 9	2/4



## Naturschieferplatte

natural slate tray  
bandeja de pizarra natural  
plat ardoise naturelle



	cm	✱ mm
00996	45 x 30	6 - 9



00994

## Naturschieferplatte

natural slate tray  
bandeja de pizarra natural  
plat ardoise naturelle



	cm	✱ mm
00994	25 x 25	6 - 9
00995	30 x 30	6 - 9

## Buffet & Display



### Naturschieferplatte

natural slate  
bandeja de pizarra natural  
plateau ardoise naturelle



	cm	✱ mm
00941	24,0 x 15,0	6 - 9
00942	26,5 x 20,5	6 - 9
00945	47,0 x 10,0	6 - 9
00988	30,0 x 12,0	6 - 9

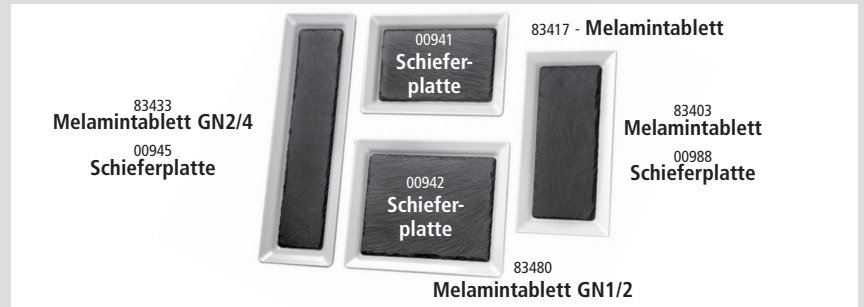

### GN 1/1 Naturschieferplatte „HOCHSTAPLER“

GN 1/1 natural slate tray  
GN 1/1 bandeja de pizarra natural  
GN 1/1 plat ardoise naturelle



	cm	↑ cm	✱ mm
00966	53 x 32,5	6	6 - 9



Griffe verchromt, 4 cm Nutzhöhe  
chrome plate handles, 4 cm distance



### Naturschieferplatte

natural slate tray  
bandeja pizarra natural  
plat ardoise naturelle



mit Absatz Ø 6 cm  
with hole Ø 6 cm  
con agujero Ø 6 cm  
avec trou Ø 6,0 cm

	cm	✱ mm
00986	25 x 12	6 - 9

passende Gläser:

82310, 82312, 82314, 82316



### Naturschieferplatte

natural slate tray  
bandeja pizarra natural  
plat ardoise naturelle



mit 3 Absätzen, Ø 6 cm  
with 3 holes, Ø 6 cm  
con 3 agujeros, Ø 6 cm  
avec 3 trous, Ø 6 cm

	cm	✱ mm
00987	28 x 10	6 - 9

passende Gläser:

82310, 82312, 82314, 82316



**Naturschieferplatte „STARTER“**

natural slate tray  
bandeja de pizarra natural  
plat ardoise naturelle carré



	cm	mm
00937	20 x 10	6 - 9



**Naturschieferplatte / Untersetzer**

natural slate tray  
bandeja de pizarra natural  
plateau ardoise naturelle



mit 2 Absätzen Ø 6 cm  
with 2 holes Ø 6 cm  
con 2 agujeros Ø 6 cm  
avec 2 trous Ø 6 cm

	cm	mm
00971	15 x 8	6 - 9



**Naturschieferplatte**

natural slate tray  
bandeja de pizarra natural  
plat ardoise naturelle



	Ø cm	mm
00968	22	6 - 9
00969	28	6 - 9
00998	33	6 - 9
00999	38	6 - 9



**Tortenplatte / Servierplatte drehbar**

cake stand  
soporte para pastel  
présentoir à gâteaux



	Ø cm	↑ cm	mm
00975	32	2,5	6 - 9



**drehbar**  
rotating



**Rolltop-Set, 3-teilig**

rolltop set, 3 pcs.  
rolltop, set de 3  
rolltop, set de 3



1 Edelmetalltablett Ø 38 cm + 1 Naturschieferplatte Ø 33 cm + 1 Rolltophaube Ø 38 cm  
1 stainless tray Ø 38 cm + 1 natural slate tray Ø 33 cm + 1 rolltop cover Ø 38 cm  
1 bandeja de acero inoxidable Ø 38 cm + 1 bandeja de pizarra natural Ø 33 cm + 1 tapa abatible Ø 38 cm  
1 plat inox 38 cm + 1 plat ardoise naturelle 33 cm + 1 cloche 38 cm

	Ø cm	↑ cm
01000	38	24



### 3-stufige Etagère

3-tier tray  
bandeja con tres alturas  
étagère carré 3 hauteurs

Naturschiefer, Akazienholz  
natural slate tray, wood akazie  
bandeja de pizarra natural, madera de acacia  
plateau ardoise naturelle, bois d'acacia



	∅ cm	↑ cm	* mm
00960	30 / 25 / 20	34	6 - 9



### 2-stufige Etagère

2-tier tray  
bandeja dos alturas  
étagère carré 2 hauteurs

Naturschiefer  
natural slate tray  
bandeja de pizarra natural  
plateau ardoise naturelle



	∅ cm	↑ cm	* mm
00989	25 / 20	24	6 - 9



### Naturschieferplatte, 2-teilig

natural slate tray, 2 pcs. set  
bandeja de pizarra natural y campana  
plateau ardoise naturelle et cloche en verre

mit Glashaube  
with glass cover  
con tapa de cristal  
avec cloche en verre



	∅ cm	↑ cm	* mm
00984	10,5	8	6 - 9



### Naturschieferplatten, 4er Set

natural slate tray, 4 pcs. set  
bandeja pizarra natural, set de 4  
plat ardoise naturelles, set de 4



	cm	* mm	pcs.
00997	10 x 10	6 - 9	4



# GENUSSPALETTE



## GN 1/1 Servierbrett „GENUSSPALETTE“

GN 1/1 serving board  
GN 1/1 tabla de servir  
GN 1/1 planche de service

HOLZ  
WOOD



Genusspalette im Kleinformat, Birke  
mini serving palett, birch  
tabla de servir, formato pequeño, abedul  
planche de service, petit format, bouleau

	cm	↑ cm	GN
00879	53 x 32,5	3	1/1



## Servierbrett „GENUSSPALETTE“

serving board  
tabla de servir  
planche de service

HOLZ  
WOOD



Genusspalette im Kleinformat, Birke  
mini serving palett, birch  
tabla de servir, formato pequeño, abedul  
planche de service, petit format, bouleau

	cm	↑ cm
00880	20 x 12	3
00881	30 x 20	3
00882	40 x 15	3

Wachspapier „SNACKHOLDER“ / greaseproof paper squares  
papel alimenticio para cucurucho / papier alimentaire pour cornet

	cm	pcs.	
40670	42 x 25	500	Motiv: Zeitung
40671	42 x 25	500	blank
40672	42 x 25	500	Motiv: rote Karos / red
40673	42 x 25	500	Motiv: blaue Karos / blue
40674	30 x 20	500	Motiv: Fast Food / black





mit Absatz Ø 5 cm  
with hole Ø 5 cm

**Servierbrett, 2-tlg.**  
serving board, 2 pcs. set  
tabla de servir, set de 2  
planche de service, set de 2

SCHIEFER  
SLATE

HOLZ  
WOOD



2-teilig:  
1 Holzbrett aus Akazienholz + 1 Naturschieferplatte  
1 wood board made of acacia wood + 1 natural slate tray  
1 tabla de madera de acacia + 1 pizarra natural  
1 planche en bois d'acacia + 1 ardoise naturelle

	cm	↑ cm
00814	28 x 17,5	2

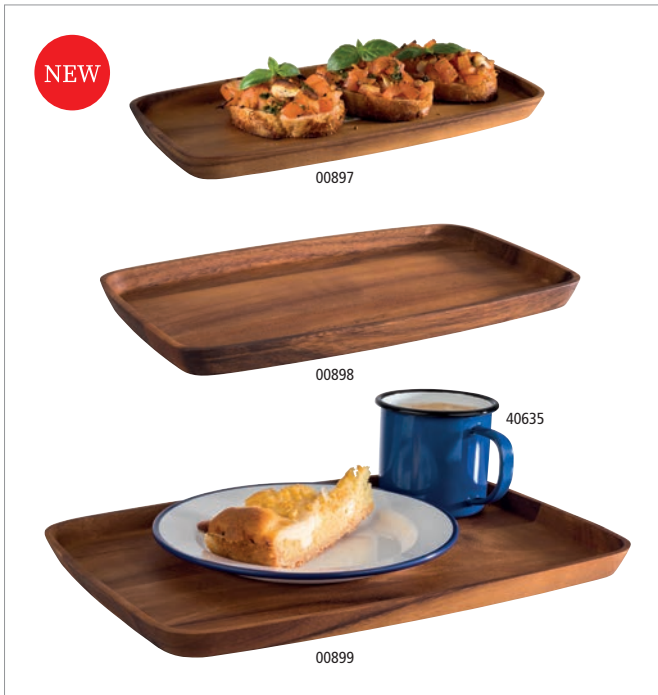

00897

00898

40635

00899

**Servierbrett**  
serving board  
tabla de servir  
planche de service



Servierbrett aus geöltem Akazienholz  
serving board made of oiled acacia wood  
tabla de servir de madera de acacia aceitada  
planche en bois avec plateau en bois d'acacia huilé

	cm	↑ cm
00897	30 x 15	2
00898	30 x 18	2
00899	35 x 25	2



00810

00811

00812

00813

**Servierbrett, 2-tlg.**  
serving board, 2 pcs. set  
tabla de servir, set de 2  
planche de service, set de 2

SCHIEFER  
SLATE

HOLZ  
WOOD



2-teilig:  
Ein rustikales Servierbrett aus Akazienholz,  
ausgestattet mit einer Naturschieferplatte  
wood board oiled acacia with a slate tray  
tabla de madera de acacia con una bandeja de pizarra natural  
planche en bois d'acacia avec un plateau en ardoise naturelle

	cm	↑ cm
00810	26 x 18	2
00811	33 x 20	2
00812	40 x 15	2
00813	43 x 12	2

**Präsentationsmöglichkeit**  
presentation example



00813

mit Hängeloch Ø 2 cm / with a handle-hole Ø 2 cm

NEW



**Servierbrett**  
 serving board  
 tabla de servir  
 planche de service



Servierbrett aus geöltem Akazienholz  
 serving board made of oiled acacia wood  
 tabla de servir de madera de acacia aceiteada  
 planche en bois d'acacia huilé

	cm	↑ cm	Griff / handle cm
00887	51,5 x 18	1,5	8,5



00867



00868

**Servierbrett „AKAZIE-SCHIEFER“**  
 serving board  
 tabla de servir  
 planche de service

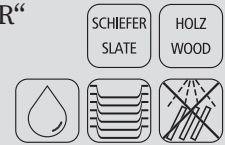

raffiniertes, rustikales Servierbrett  
 aus Akazienholz, ausgestattet mit einem Naturschieferstreifen  
 zur Kennzeichnung

wood with slate, markable  
 madera con pizarra, se puede marcar  
 bois avec ardoise, on peut mettre une inscription

	cm	↑ cm
00867	30,5 x 13	1,5
00868	36,5 x 15	1,5
00869	42,0 x 18	1,5



00870



00873



00875

**Servierbrett „OLIVE“**  
 serving board  
 tabla de servir en madera de olivo  
 planche de service en bois d'olivier



Servierbrett im Naturschnitt, aus Olivenholz. Jedes Brett wird handgefertigt und geölt mit 19 mm Aufhäng Bohrung. Alle Produkte unterscheiden sich naturbedingt in Form, Maserung und Größe!

Olive Wood is known for its versatility and striking appearance with each piece having its own unique features.

El olivo es conocido por su versatilidad y aspecto espectacular y único en cada pieza. Por su fabricación a mano de forma artesanal, todas las piezas varían en tamaño, forma y acabado, lo que hace de cada una un ejemplar único.

Le bois d'olivier est reconnu pour sa versatilité et son esthétique spectaculaire. De par leur fabrication artisanale à la main, toutes les pièces varient quant à leur taille, forme et finition, de telle sorte que chacune est un exemplaire unique.

	cm	↑ cm	Griff / handle cm
00870	25 x 17,0	1,5	
00871	30 x 20,5	2,0	
00872	35 x 24,0	2,0	
00873	40 x 15,0	1,5	11
00874	44 x 20,0	2,0	12
00875	19 x 12,5	1,5	6
00876	25 x 16,0	1,5	8
00877	31 x 20,0	1,5	9



**Servierbrett „OAK“**

serving board  
tabla de servir  
planche de service



aus geöltem Eichenholz, Safrille, ø 9,5 cm runde Aussparung  
made of oiled oak, with juice groove, with hole ø 9.5 cm  
de madera de roble aceitada, con ranura para líquidos, con agujero ø 9,5 cm  
en bois chêne huilé, avec rigole, avec trou ø 9,5 cm

	cm	↑ cm
00808	37 x 25	2



mit Safrinne / with juice groove

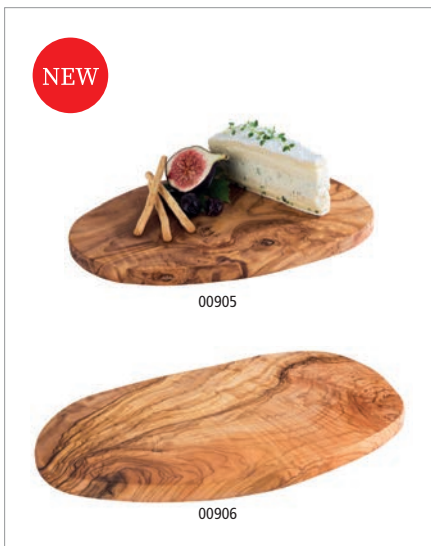

**Servierbrett „OLIVE“**

serving board  
tabla de servir  
planche de service



aus geöltem Olivenholz  
oiled olive wood  
de madera de olivo aceitada  
en bois d'olivier huilé

	cm	↑ cm
00905	25,5 x 16,5	1,5
00906	35,0 x 20,5	1,5



**Rindenholzbrett**

wood plater  
tabla de madera con corteza  
planche en bois avec écorce



Akazienholz mit Rinde, jedes Brett ein Unikat,  
vor dem Erstgebrauch mit Speiseöl behandeln  
acacia wood with bark, each board unique,  
treat with cooking oil before first use  
madera de acacia con corteza, cada tabla un ejemplar  
único, tartar con aceite de cocina antes del primer uso  
bois d'acacia avec écorce, chaque planche une modèlle unique,  
traiter avec de l'huile de caisson avant la première utilisation

	cm	↑ cm
00895	26 x 24,0	2
00896	30 x 28,5	2





**Schale „OLIVE“**

bowl  
cuenco  
bol



aus geöltem Olivenholz  
oiled olive wood  
de madera de olivo aceitada  
en bois d'olivier huilé

	cm	↑ cm	litr.
00843	12,0 x 7,5	2,5	0,05
00844	16,5 x 9,5	2,5	0,10



**Schale „OLIVE“**

bowl  
cuenco  
bol



aus geöltem Olivenholz  
oiled olive wood  
de madera de olivo aceitada  
en bois d'olivier huilé

	cm	↑ cm	litr.
00907	13 x 8	6,5	0,2
00908	16 x 9	7,0	0,3



**Servierbrett „NARROW“**

servicing board  
tabla de servir  
planche de service



Akazienholz, mit 3 Vertiefungen Ø 6 cm  
acacia wood, with 3 notches Ø 6 cm  
madera de acacia, con 3 ranuras Ø 6 cm  
bois d'acacia, avec 3 encoches Ø 6 cm

	cm	↑ cm
00878	31 x 11	2

passende Schälchen / fitting bowls / cuencos adecuados / bols apropiés

	Ø cm	↑ cm	litr.	
40685	6	3	0,05	stainless steel



**Holzbox „TABLE“**

woodbox  
caja madera  
base bois



Akazienholz, 3 Fächer (6,5 x 6,5 cm)  
acacia wood, 3 compartments (6,5 x 6,5 cm)  
madera de acacia, 3 compartimentos (6,5 x 6,5 cm)  
bois d'acacia, 3 compartiments (6,5 x 6,5 cm)

	cm	↑ cm	inner size cm
11727	23,5 x 8,5	4,5	6,5 x 6,5 je Fach / each compartment



**NEW** Buffetbrett „PROFI“



**Buffetbrett „PROFI“**  
board  
tabla para el buffet  
planche découper buffet



aus geöltem Eichenholz, Safrinne, mit Antirutsch-Füßchen

made of oiled oak, with juice groove and non slip-feet

de madera de roble aceitada, con ranura para líquidos y pies antideslizantes

en bois chêne huilé, avec rigole et pieds antidérapants

	Ø cm	↑ cm	passende Haube / suitable cover / campana adecuada / cloche appropriée
00815	23	4,5	6519
00805	33	4,5	6520, 6510, 6512
00816	39	4,5	6521

**Frischhalte- Haube / cover / campana / cloche**



	Ø cm	↑ cm	fits to
06512	30	11,5	85051, 85052

**Frischhalte- Haube / cover / campana / cloche**



	Ø cm	↑ cm	fits to
06519	21	17	85049, 85050
06520	30	22	85051, 85052
06521	36	27	85053, 85054



**Buffetbrett „PROFI“**  
board  
tabla para el buffet  
planche découper buffet



aus geöltem Eichenholz, Safrinne, mit Antirutsch-Füßchen

made of oiled oak, with juice groove and non slip-feet

de madera de roble aceitada, con ranura para líquidos y pies antideslizantes

en bois chêne huilé, avec rigole et pieds antidérapants

	cm	↑ cm	passende Haube / suitable cover / campana adecuada / cloche appropriée
00807	38 x 32,0	4,5	11021, 11022, 12008, 12010
00806	58 x 37,5	4,5	11026, 11027, 11028, 11008, 11010, 11016



### Buffetbrett „XXL“

board  
tabla para el buffet  
planche à découper buffet



**Buchenholz geölt, mit Antirutsch-Füßchen**

beech wood oiled, with non-slip feet  
madera de haya tratada con aceite, con pies antideslizantes  
bois hêtre huilé, avec pieds antidérapants

	Ø cm	↑ cm
00866	50	4,5

### Rolltophaube / rolltop cover / campana rolltop / cloche rolltop

	Ø cm	↑ cm
18380	50	26

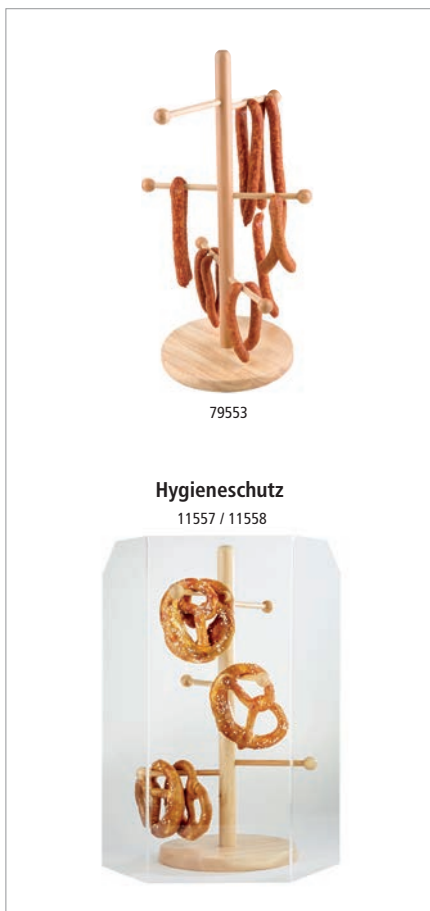

### Brezel- oder Wurstständer

pretzel-/ sausage stand  
soporte para embutidos  
support à bretzel ou à saucissons



**Verkaufsständer Buchen-Holz versiegelt, bestens geeignet für die Präsentation von Brezeln, Würstchen, etc., Fuß Ø 22 cm**

beech wood, ideal to present pretzels, sausages, etc.  
madera de haya, ideal para presentar fiambres, salchichones etc.  
en hêtre, idéal pour bretzels ou saucissons, etc.

	Ø cm	↑ cm
79553	28	50

### Hygieneschutz für Brezelständer / hygienic cover / cubierta higiénica antialiento / pare-haleine

	cm	↑ cm
11557	20 x 20 x 20	50
11558	15 x 20 x 15	50



### Hobel für Käse und Schokolade

cheese / choco curler  
rizador para queso y chocolate  
frisette pour fromage et chocolat



**3-teilig: Platte Buchen-Holz versiegelt Ø 22 cm mit senkrechtem Stift + Hobel 7 cm + Haube Ø 15 x 10 cm, für Käse und Schokolade**

3 pcs. set: wooden base Ø 22 cm with vertical bolt + plough 7 cm + cover Ø 15 x 10 cm, for cheese and chocolate

set de 3: base de madera Ø 22 cm, con eje vertical de 7 cm + campana Ø 15 x 10 cm, para „rizar“ queso y chocolate

set de 3: base bois Ø 22 cm, axe vertical ht. 7 cm, cloche Ø 15 x ht 10 cm, pour „friser“ le fromage ou le chocolat.

	Ø cm	↑ cm
50002	22	15

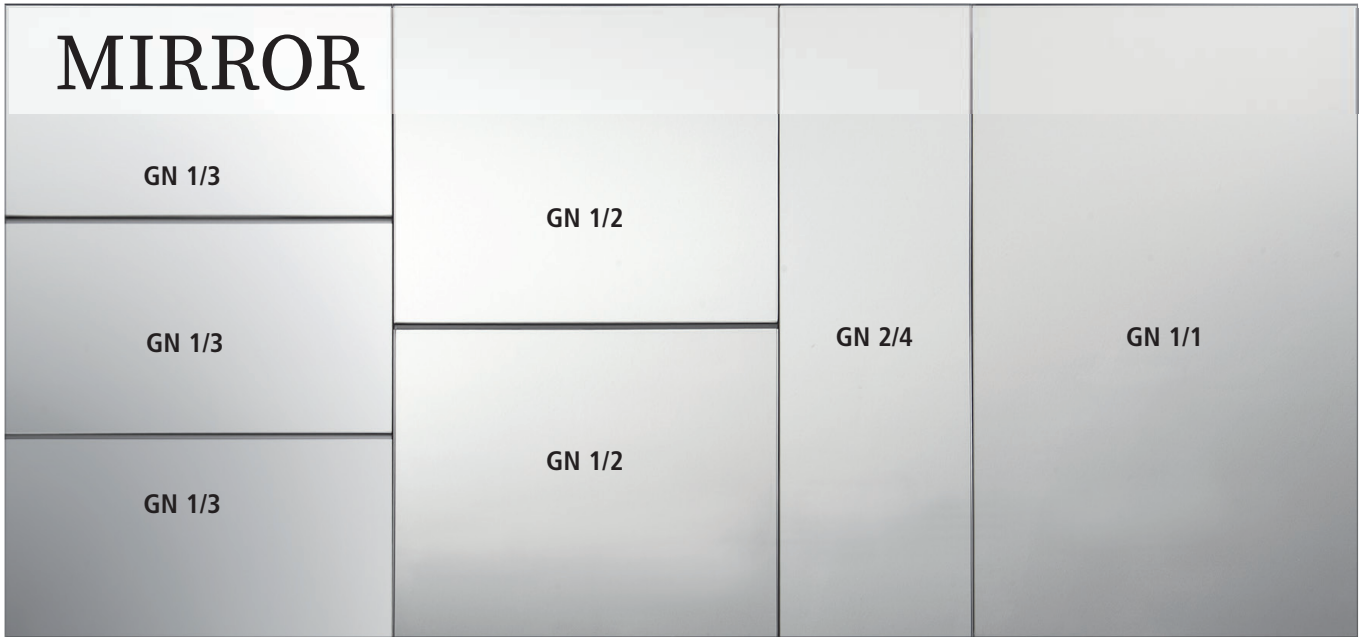

**GN Glasplatte „MIRROR“**

GN glass platter  
GN espejos sobre vidrio  
GN plateau miroir en verre



silber spiegelndes Glas, mit Antirutsch-Füßchen  
silver mirror glas, non-slip feet  
espejo plateado, pies antideslizantes  
plateau miroir argenté, pieds antiglisse

	cm	↑ cm	GN
00961	53,0 x 32,5	3	1/1
00962	32,5 x 26,5	3	1/2
00963	32,5 x 17,6	3	1/3
00964	53,0 x 16,2	3	2/4



**ZERO**



**GN Tablett „ZERO“**

GN tray  
GN bandeja  
GN plateau



glatte, hochglänzende Oberfläche  
smooth and shiny surface  
superficie lisa con acabado brillante  
surface lisse et finition brillante

	cm	↑ cm	GN	Farbe / Colour
84185	53,0 x 32,5	1,5	1/1	White
84186	32,5 x 26,5	1,5	1/2	White
84187	32,5 x 17,6	1,5	1/3	White
84188	26,5 x 16,2	1,5	1/4	White
84189	53,0 x 16,2	1,5	2/4	White
84195	53,0 x 32,5	1,5	1/1	Black
84196	32,5 x 26,5	1,5	1/2	Black
84197	32,5 x 17,6	1,5	1/3	Black
84198	26,5 x 16,2	1,5	1/4	Black
84199	53,0 x 16,2	1,5	2/4	Black



GN Tablett „FRAMES“

GN tray  
GN bandeja  
GN plateau



	cm	↑ cm	GN
82355	53,0 x 32,5	2	1/1
82356	32,5 x 26,5	2	1/2
82357	32,5 x 17,6	2	1/3



GN Tablett

GN tray  
GN bandeja  
GN plateau



	cm	↑ cm	GN
82201	53,0 x 32,5	2,5	1/1
82202	32,5 x 26,5	2,5	1/2
82203	32,5 x 17,6	2,5	1/3
82204	53,0 x 16,2	2,5	2/4
82205	35,4 x 32,5	2,5	2/3



GN Tablett „FRAMES“

GN tray  
GN bandeja  
GN plateau



	cm	↑ cm	GN
84046	53,0 x 32,5	2	1/1
84047	32,5 x 26,5	2	1/2
84048	32,5 x 17,6	2	1/3



Serviertablett „HAPPY HOUR“

tray  
bandeja  
plateau



rutschfeste Oberfläche  
non-slip surface  
superficie anti deslizando  
surface antidérapante

	Ø cm	↑ cm	Farbe / Colour
00510	32	1,5	■
00511	38	1,5	■
00515	43	1,5	■



Tablett „GASTRO“

tray  
bandeja  
plateau



rutschfeste Oberfläche  
non-slip surface  
superficie anti deslizando  
surface antidérapante

	Ø cm	↑ cm	Farbe / Colour
00547	27,5	2	■
00548	35,5	2	■
00549	40,5	2	■



Tablett „BISTRO“

tray  
bandeja  
plateau



rutschfest, mit 2 Griffmulden und Stapelrand  
non-slip, two open handles, stackable edge  
anti deslizando, 2 asas  
antidérapant, 2 anses

	Ø cm	↑ cm	Farbe / Colour
84045	35,5	4,5	■



Bierglasträger „NONSLIP“

beer rack  
bandeja para cerveza  
porte verre à bière



rutschfeste Oberfläche  
non-slip surface  
superficie anti deslizando  
surface antidérapante

	Ø cm	↑ cm	Farbe / Colour
00500	36	3,5	■
00501	36	3,5	■

	cm	↑ cm	Farbe / Colour
00506	28 x 20	1,5	■
00507	28 x 20	1,5	■



**Teller mit Glashalter „COCKTAIL“**

plate with glass holder  
plato sujeta copas  
assiette porte-verre



eignet sich besonders für Stehempfänge, einhändig nutzbar  
particularly suitable for standing receptions, single-handed use  
para uso en recepciones de pie, facil de usar con sólo una mano  
particulièrement pour des receptions debout, utilisable avec une seule main

	cm	↑ cm
84620	22 x 14	1,5



	Ø cm	↑ cm
84621	19	1,5



**Serviertablett „NONSLIP“**

tray non-slip  
bandeja  
plateau



rutschfeste Oberfläche  
non-slip surface  
superficie antideslizante  
surface antidérapante

	cm	↑ cm	GN	Farbe / Colour
00502	53,0 x 32,5	1,5	1/1	
00508	46,0 x 36,0	2,0		
00505	53,0 x 32,5	1,5	1/1	
00503	53,0 x 37,0	1,5		



**Tablett**

tray  
bandeja  
plateau



rutschfest, Holzdekor-Laminat  
non-slip, coated wood  
antideslizante, decoración madera láminae  
antidérapant, décor bois laminé

	cm	↑ cm
00524	43,5 x 31,5	1,5
00525	52,0 x 39,0	1,5
00526	60,5 x 42,5	1,5

## Buffet & Display



### Fast Food-Tablett

snack tray  
bandeja autoservicio y snacks  
plateau self-service et snacks



	cm	↑ cm	GN	Farbe / Colour
00530	35 x 27,0	2		
00535	41 x 30,5	2		
00540	45 x 35,5	2		
00552	53 x 32,5	2	1/1	

	cm	↑ cm	GN	Farbe / Colour
00531	35 x 27,0	2		
00536	41 x 30,5	2		
00541	45 x 35,5	2		
00553	53 x 32,5	2	1/1	

	cm	↑ cm	GN	Farbe / Colour
00532	35 x 27,0	2		
00537	41 x 30,5	2		
00542	45 x 35,5	2		
00554	53 x 32,5	2	1/1	

	cm	↑ cm	GN	Farbe / Colour
00533	35 x 27,0	2		
00538	41 x 30,5	2		
00543	45 x 35,5	2		
00555	53 x 32,5	2	1/1	



### Tablett

tray  
bandeja  
plateau



**rutschfest, Mahagonifurnier**

non-slip, woodform, mahogany  
antideslizante, revestimento de caoba  
antidérapant, placage en acajou

	Ø cm	↑ cm	
00528	31,0	3,5	hoher Rand
00529	35,5	3,5	hoher Rand

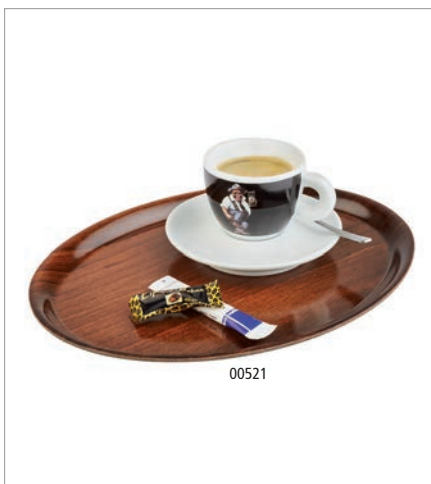

### Tablett

tray  
bandeja  
plateau



**rutschfest, Holzdekor-Laminat**

non-slip, coated wood  
antideslizante, limando decoracion madera  
antidérapant, décor bois stratifié

	cm	↑ cm	
00521	26 x 20	1	
00522	29 x 21	1	





**DRESSINGTOPF-DISPLAY /-STATION**

wooden station for 3 dressing pots  
 expositor de madera para 3 salsaeras  
 présentoir en bois pour 3 pots à sauce



inkl. 3 Beschriftungsschilder aus Metall  
 incl. 3 metal labels  
 incl. 3 etiquetas de metal  
 incl. 3 étiquettes métalliques

	cm	↑ cm
84863	40 x 16	9



passend für 83311, 83867, 30060  
 suitable for 83311, 83867, 30060



**Dressingtopf „PASTELL“**

dressing pot  
 salsaera  
 pot à sauce



	cm	↑ cm	ltr.	Farbe / Colour
84862	13	19,5	1,5	Green
84860	13	19,5	1,5	White
84861	13	19,5	1,5	Pink

Beschriftungsetiketten, 72 Stück / labeling labels, 72 pcs. set  
 etiquetas, 72 pzs / étiquettes, 72 pcs.

	cm	Farbe / Colour
00069	8 x 4,6	Black



mit Antirutschfüßchen  
 with non-slip feet  
 con pies antideslizantes  
 avec pieds antidérapants



stapelbar  
 stackable  
 apilable  
 empilable



**Dressingtopf, doppelwandig „PROFI“**

dressing pot, double wall  
 salsaera alta, doble pared  
 pot à sauce, double paroi



beste Isoliereigenschaften  
 best insulating properties  
 muy aislante  
 très isolant

	Ø cm	↑ cm	ltr.
30060	13	19	1,4

Beschriftungsetiketten, 72 Stück / labeling labels, 72 pcs. set  
 etiquetas, 72 pzs / étiquettes, 72 pcs.

	cm	Farbe / Colour
00069	8 x 4,6	Black

## Buffet & Display



### Dressingtopf „CASUAL“

dressing pot  
salsera  
pot à sauce



	cm	↑ cm	ltr.	Farbe / Colour
83867	12	21,5	1	weiß



### Dressingtopf „CASUAL“

dressing pot  
salsera  
pot à sauce



	cm	↑ cm	ltr.	Farbe / Colour
83868	12	21,5	1	schwarz



### Dressingtopf, doppelwandig

bowl, double wall  
salsera alta, doble pared  
pot à sauce, double paroi



**beste Isoliereigenschaften**  
best insulating properties  
muy aislante  
très isolant

	Ø cm	↑ cm	ltr.
30043	15	18	1,8



### Dressingtopf

dressing pot  
salsera  
pot à sauce



**Deckel mit Löffelaussparung**  
cover notched for spoon  
tapa agujereada para el cucharón  
couverture avec espace pour la louche

	Ø cm	↑ cm	ltr.
83309	18,5	17	2,3
83310	17,0	15	2,0
83311	13,0	13	0,8



**Kühl-Akkus halten Ihre Speisen bis zu 6 Stunden kühl**  
cooler keeps the food until 6 hrs. cold

**Buffetvitrine**  
showcase  
vitrina de buffet  
vitrine de buffet



1 transparente Rolltophaube beidseitig aufklappbar + 1 Schale (ABS)  
+ 1 Edelstahl-Tablett 39 x 28 cm + 2 Kühl-Akkus

1 transparent rolltop cover + 1 tray (ABS) + 1 stainless tray 39 x 28 cm + 2 coolers, demountable

1 tapa abatible transparente + 1 bandeja (ABS) + 1 bandeja 39x28cm + 2 enfriadores, desmontable

1 cloche transparente ouverture 2 côtés + 1 caisson (ABS) + 1 plateau inox 39 x 28 cm + 2 accumulateurs de froid, démontable

	cm	↑ cm	Farbe / Colour
09100	44 x 32	20,5	
09102	44 x 32	20,5	
09104	44 x 32	20,5	

**Kühlakku / cooler / acumulador de frío / accumulateur de froid**

	cm	↑ cm	pcs.
11101	16 x 7,5	2	4

**Edelstahl-Tablett / stainless steel tray / bandeja de acero inoxidable / plateau inox**

	cm
90902	39 x 28



**Kühl-Akkus halten Ihre Speisen bis zu 6 Stunden kühl**  
cooler keeps the food until 6 hrs. cold

**Thermo Tablett-Set**  
thermo tray  
bandeja termo  
caisson thermo



1 stabile Schale + 1 Edelstahl-Tablett + 2 Kühlakkus + 1 Frischhaltehaube

1 plastic tray + 1 stainless tray + 2 coolers + 1 cover

1 bandeja de plástico + 1 bandeja inox + 2 acumuladores + 1 campana

1 plateau plastique + 1 plateau inox + 2 accumulateurs de froid + 1 cloche

	cm	↑ cm
09090	43 x 29	14

**Kühlakku / cooler / acumulador de frío / accumulateur de froid**

	cm	↑ cm	pcs.
11101	16 x 7,5	2	4

**Haube / cover / campana / cloche**

	cm	↑ cm
90901	43 x 29	14

**Edelstahl-Tablett / stainless steel tray / bandeja de acero inoxidable / plateau inox**

	cm
90902	39 x 28

## Buffet & Display



### Buffetvitrine „DOPPELDECKER“

showcase  
vitrina de buffet, 2 alturas  
vitrine de buffet double



2 transparente Rolltopphauben beidseitig aufklappbar + 2 Edelstahl-Tablets 39 x 28 cm  
+ 4 Kühl-Akkus, platzsparend lagerbar

2 transparent rolltop cover + 2 tray 39 x 28 cm + 4 coolers, demountable, space saving  
2 campanas abatibles por ambos lados + 2 bandejas 39 x 28 cm + 4 acumuladores,  
desmontable, ahorra espacio

2 cloches transparentes abattantes 2 côtés + 2 plateaux 39 x 28 cm + 4 accumulateurs de  
froid, gain d'espace

	cm	↑ cm	Farbe / Colour
09200	44 x 32	44	
09202	44 x 32	44	
09204	44 x 32	44	

#### Kühlakku / cooler / acumulador de frío / accumulateur de froid

	cm	↑ cm	pcs.
11101	16 x 7,5	2	4

#### Edelstahl-Tablett / stainless steel tray / bandeja de acero inoxidable / plateau inox

	cm
90902	39 x 28



### Thermo Tablett-Set

thermo tray  
bandeja termo  
caisson thermo



1 stabile Schale + 1 Edelstahl-Tablett + 2 Kühlakkus + 1 Frischhaltehaube

1 plastic tray + 1 stainless tray + 2 coolers + 1 cover

1 bandeja de plástico + 1 bandeja inox + 2 acumuladores + 1 campana

1 plateau plastique + 1 plateau inox + 2 accumulateurs de froid + 1 cloche

	Ø cm	↑ cm
09093	35	15

#### Kühlakku / cooler / acumulador de frío / accumulateur de froid

	cm	↑ cm	pcs.
11101	16 x 7,5	2	4

**Kühl-Akkus halten Ihre Speisen  
bis zu 6 Stunden kühl  
cooler keeps the food until  
6 hrs. cold**



**Buffet-Set „FOCUS“**

buffet set  
set de buffet  
présentoir pour le buffet

4-teilig: Box, Tablett, 2 Kühlakkus

4 pcs.: box, tray, 2 cooler  
set de 4.: box, bandeja, 2 enfriadores  
swt de 4: caisson, 2 plateau, bac



	cm	↑ cm	Farbe / Colour
09000	43,5 x 32,5	6	White
09001	43,5 x 32,5	6	Black

**Edelstahltablett / tray / bandeja / plateau**

	cm	↑ cm
09010	43,5 x 32,5	1,5

**Holzschneidebrett / wooden board / tablero de madera / planche à découper**

	cm	↑ cm
09016	43,5 x 32,5	2

**Basisteil / base / base / base**

	cm	↑ cm	Farbe / Colour
09011	42,5 x 31,5	6	White
09012	42,5 x 31,5	6	Black

**Rolltophaube „PURE“ / rolltop cover / campana abatible / cloche basculante**

	cm	↑ cm
09013	44 x 33,5	17

**Kühlakku / cooler / acumulador de frío / accumulateur de froid**

	cm	↑ cm
10791	25 x 19	2,5

**Kühl-Akkus halten Ihre Speisen bis zu 6 Stunden kühl**  
cooler keeps the food until 6 hrs. cold



**Buffet-Set „FOCUS“**

buffet set  
set de buffet  
présentoir pour le buffet

3-teilig: Box, Tablett, 1 Kühlakku

3 pcs.: box, tray, 1 cooler  
set de 3.: box, bandeja, 1 enfriador  
set de 3: caisson, 1 plateau, bac



	Ø cm	↑ cm	Farbe / Colour
09002	38	6	White
09003	38	6	Black

**Edelstahltablett / tray / bandeja / plateau**

	Ø cm	↑ cm
09020	38	1,5

**Basisteil / base / base / base**

	Ø cm	↑ cm	Farbe / Colour
09021	37	6	White
09022	37	6	Black

**Rolltophaube / rolltop cover / campana abatible / cloche basculante**

	Ø cm	↑ cm
09023	38	20

**Kühl-Akkus halten Ihre Speisen bis zu 6 Stunden kühl**  
cooler keeps the food until 6 hrs. cold

## Buffet & Display

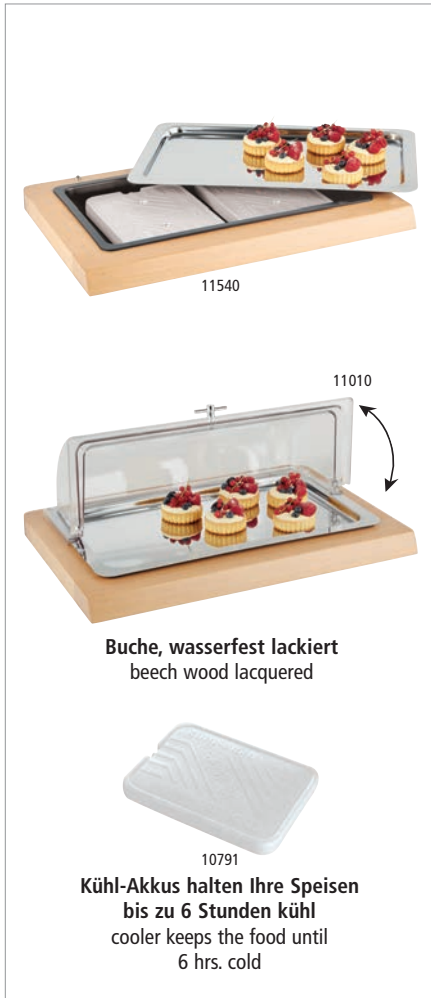

### Buffetvitrine „TOP FRESH GN 1/1“

refrigerated buffet display  
expositor buffet frío  
plateau buffet froid



4-teilig: 1 Holzbox mit Kunststoffwanne + 1 Tablett GN 1/1 + 2 Kühllakku

4 pcs. set: 1 woodbox with plastic insert + 1 stainless tray GN 1/1 + 2 coolers

set de 4: 1 base madera + 1 bandeja inox GN 1/1 + 2 acumuladores de frío

set de 4: 1 base bois + 1 plateau inox GN 1/1 + 2 accus de froid (cloche non incluse)

	cm	↑ cm
11540	60 x 41	5

GN Rolltophaube / GN rolltop cover / GN campana rolltop / GN cloche rolltop

	cm	↑ cm	GN
11008	53 x 32,5	19	1/1 Gold-Griff

GN Rolltophaube / GN rolltop cover / GN campana rolltop / GN cloche rolltop

	cm	↑ cm	GN
11010	53 x 32,5	19	1/1 Chrom-Griff

Kühllakku / cooler / acumulador de frío / accumulateur de froid

	cm	↑ cm
10791	25 x 19	2,5



### Buffetvitrine „DOPPELDECKER“

cooling buffet display  
expositor buffet frío  
vitrine buffet



12-teilig: 2 Kästen Buchen-Holz versiegelt + 2 Tablett GN 1/1

+ 4 Kühllakku + 4 Stangen, ohne Hauben

12 pcs. set: 2 beech wood boxes waterproof + 2 trays GN 1/1 + 4 coolers + 4 fittings, without covers

set de 12: 2 bases madera tratada + 2 bandejas inox GN 1/1 + 4 enfriadores + 4 pies (campanas no incl.)

set de 12: 2 caissons bois traité (hêtre) + 2 plateaux inox GN 1/1 + 4 accus + 4 pieds (cloches non incluses)

	cm	↑ cm	
11541	60 x 41	36	verchromte Stäbe / chrome plated fittings pies cromados / pieds chromés

GN Rolltophaube / GN rolltop cover / GN campana rolltop / GN cloche rolltop

	cm	↑ cm	GN
11008	53 x 32,5	19	1/1 Gold-Griff

GN Rolltophaube / GN rolltop cover / GN campana rolltop / GN cloche rolltop

	cm	↑ cm	GN
11010	53 x 32,5	19	1/1 Chrom-Griff

Kühllakku / cooler / acumulador de frío / accumulateur de froid

	cm	↑ cm
10791	25 x 19	2,5



11542

**Buche, wasserfest lackiert**  
beech wood lacquered



18388

11542



10791

**Kühl-Akkus halten Ihre Speisen  
bis zu 6 Stunden kühl**  
cooler keeps the food until  
6 hrs. cold

**Kühltablett „TOP FRESH RUND“**

refrigerated buffet display  
expositor buffet frío redondo  
présentoir buffet



**3-teilig: 1 Holzbox mit Kunststoffwanne + 1 Edelstahl-Tablett Ø 38 cm + 1 Kühllakku**

3 pcs. set: 1 woodbox with plastic insert + 1 stainless tray Ø 38 cm + 1 cooler

set de 3: 1 caja madera + 1 bandeja inox Ø 38 cm + 1 acumulador de frío

set de 3: 1 base bois + 1 plateau inox Ø 38 cm + 1 accumulateur de froid

	Ø cm	↑ cm	cl
11542	48	6	

**Rolltophaube / rolltop cover / campana abatible / cloche basculante**

	Ø cm	↑ cm	
18388	38	20	mit verchromtem Kugelgriff

**Rolltophaube / rolltop cover / campana abatible / cloche basculante**

	Ø cm	↑ cm	
18387	38	20	mit vergoldetem Kugelgriff

**Kühllakku / cooler / acumulador de frío / accumulateur de froid**

	cm	↑ cm	
10791	25 x 19	2,5	



18388

18388

11543

**Buche, wasserfest lackiert**  
beech wood lacquered



10791

**Kühl-Akkus halten Ihre Speisen  
bis zu 6 Stunden kühl**  
cooler keeps the food until  
6 hrs. cold

**Buffetvitrine „DOPPELDECKER“**

double refrigerated buffet display  
expositor de buffet redondo doble  
présentoir buffet froid, double



**11-teilig: 2 Rahmen Buchen-Holz versiegelt + 2 Edelstahl-Tablets Ø 38 cm**

+ 2 Kühllakku + 2 Kunststoffschalen + 3 Stangen, ohne Hauben

11 pcs. set: 2 beech wood boxes waterproof + 2 stainless trays Ø 38 cm

+ 2 cooler + 2 plastic deep trays + 3 fittings, without covers

set de 11: 2 bases madera + 2 bandejas inox aprox. 38cm

+ 2 acumuladores + 2 cubetas plástico + 3 varas (campanas no incl.)

set de 11: 2 caissons bois traité (hêtre) + 2 plateaux inox approx. 38 cm

+ 2 accus + 2 bacs plastique + 3 barres (cloches non incluses)

	Ø cm	↑ cm	
11543	48	38	verchromte Stäbe / chrome fittings pies cromados / pieds chromés

**Rolltophaube / rolltop cover / campana abatible / cloche basculante**

	Ø cm	↑ cm	
18388	38	20	mit verchromtem Kugelgriff

**Rolltophaube / rolltop cover / campana abatible / cloche basculante**

	Ø cm	↑ cm	
18387	38	20	mit vergoldetem Kugelgriff

**Kühllakku / cooler / acumulador de frío / accumulateur de froid**

	cm	↑ cm	
10791	25 x 19	2,5	

## Buffet & Display



### Buffetvitrine „TOP FRESH GN 1/1“

cooling buffet display  
expositor buffet frío  
présentoir buffet



5-teilig: 1 Edelstahl-Tablett GN 1/1 + 2 Kühllakkus + 1 Edelstahl-Schale + 1 Acrylrahmen, ohne Haube

5 pcs. set: 1 stainless tray GN 1/1 + 2 cooler + 1 stainless deep tray + 1 frame acrylic, without cover

set de 5: 1 bandeja inox GN 1/1 + 2 acumuladores + 1 cubeta inox + 1 marco metacrilato (campana no incl.)

set de 5: 1 plateau inox GN 1/1 + 2 accus. de froid + 1 bac inox + 1 cadre plexi (cloche non-incl.)

	cm	↑ cm
11510	61 x 38	8

#### GN Rolltophaube / GN rolltop cover / GN campana rolltop / GN cloche rolltop

	cm	↑ cm	GN
11010	53 x 32,5	19	1/1

#### Kühllakku / cooler / acumulador de frío / accumulateur de froid

	cm	↑ cm
10791	25 x 19	2,5



### Buffetvitrine „DOPPELDECKER GN1/1“

cooling buffet display  
expositor buffet frío  
présentoir buffet



14-teilig: 2 Edelstahl-Tablets GN 1/1 + 4 Kühllakkus + 2 Edelstahl-Schale + 2 Acrylrahmen + 4 verchromte Stangen, ohne Hauben

14 pcs. set: 2 stainless tray GN 1/1 + 4 cooler + 2 stainless deep trays + 2 frames acrylic + 4 chrome plated fittings, without covers

set de 14: 2 bandejas inox GN 1/1 + 4 acum. de frío 2 cubetas inox + 2 bases metacrilato + 4 varas cromadas (sin las campanas)

set de 14: 2 plateaux inox GN 1/1 + 4 accus 2 bacs inox + 2 cadres plexi + 4 barres chromées (sans les cloches)

	cm	↑ cm
11514	61 x 38	33

#### GN Rolltophaube / GN rolltop cover / GN campana rolltop / GN cloche rolltop

	cm	↑ cm	GN
11010	53 x 32,5	19	1/1

#### Kühllakku / cooler / acumulador de frío / accumulateur de froid

	cm	↑ cm
10791	25 x 19	2,5





**Kühltablett „TOP FRESH RUND“**

cooling plate  
expositor buffet frío  
présentoir buffet



**4-teilig: 1 Edelstahl-Tablett Ø 38 cm + 2 Kühllakkus + 1 Edelstahl-Schale + 1 Acrylrahmen, ohne Haube**

4 pcs. set: 1 stainless tray Ø 38 cm + 2 cooler + 1 stainless deep tray + 1 frame acrylic, without cover

set de 4: 1 bandeja inox 38cm + 2 acum. de frío + 1 cubeta inox + 1 base metacrilato (campana no incluida)

set de 4: 1 plateau inox 38cm + 2 accum. de froid + 1 bac inox + 1 base plexi (cloche non incl.)

	Ø cm	↑ cm
11512	43,5	8

**Rolltophaube / rolltop cover / campana abatible / cloche basculante**

	Ø cm	↑ cm	
18388	38	20	mit verchromtem Kugelgriff

**Kühllakku / cooler / acumulador de frío / accumulateur de froid**

	cm	↑ cm	pcs.
11101	16 x 7,5	2	4



**Buffetvitrine „DOPPELDECKER“**

cooling plate  
expositor de buffet doble redondo  
présentoir buffet



**13-teilig: 2 Edelstahl-Tablets Ø 38 cm + 4 Kühllakkus + 2 Edelstahl-Schalen + 2 Acrylrahmen + 3 verchromte Stangen, ohne Hauben**

13 pcs. set: 2 stainless trays Ø 38 cm + 4 cooler + 2 stainless deep tray + 2 frames acrylic + 3 chrome plated fittings, without covers

set de 13: 2 bandejas inox 38 cm + 4 acumuladores de frío + 3 varas cromadas + 2 bases + 2 bandejas, campana no incluida

set de 13: 2 plateaux inox 38cm + 4 accum. de froid + 2 bacs inox + 2 bases plexi + 3 barres chromées (cloche non incl.)

	Ø cm	↑ cm
11516	43,5	33

**Rolltophaube / rolltop cover / campana abatible / cloche basculante**

	Ø cm	↑ cm	
18388	38	20	mit verchromtem Kugelgriff

**Kühllakku / cooler / acumulador de frío / accumulateur de froid**

	cm	↑ cm	pcs.
11101	16 x 7,5	2	4

## Buffet & Display



### Kühlbox „TOP FRESH GN 1/1“

cooling plate  
bandeja de frío  
présentoir buffet réfrigéré



4-teilig: 1 Kühlbox + 1 Tablett GN 1/1 + 2 Kühlakkus, ohne Haube

4 pcs. set: 1 box + 1 tray GN 1/1 + 2 coolers, without cover

set de 4: 1 caja plástico blanco + 1 bandeja GN 1/1 + 2 acum. de frío, campana no incluida

set de 4: 1 caisson plastique blanc + 1 plateau GN 1/1 + 2 accum. de froid, cloche non incl.

	cm	↑ cm	Farbe / Colour
11503	56,5 x 35	6,5	White
11505	56,5 x 35	6,5	Black

GN Rolltophaube / GN rolltop cover / GN campana rolltop / GN cloche rolltop

	cm	↑ cm	GN
11008	53,0 x 32,5	19	1/1 mit vergoldetem Kreuzgriff

GN Rolltophaube / GN rolltop cover / GN campana rolltop / GN cloche rolltop

	cm	↑ cm	GN
11010	53 x 32,5	19	1/1 mit verchromtem Kreuzgriff

Kühlakku / cooler / acumulador de frío / accumulateur de froid

	cm	↑ cm
10791	25 x 19	2,5

GN Edelstahl-Tablett „PROFI LINE“ / GN tray / GN bandeja / GN plat empilable système catering

	cm	↑ cm	GN
11100	53 x 32,5	1,5	1/1



### Kühlbox „TOP FRESH GN 1/1“

cooling box  
expositor buffet frío  
présentoir buffet



4-teilig: 1 Kühlbox + Tablett GN 1/1 + 2 Kühlakkus, ohne Haube

4 pcs. set: 1 box + 1 tray GN 1/1 + 2 cooler, without rolltop cover

set de 4: 1 cajón + 1 bandeja GN 1/1 + 2 enfriadores, campana no incluida

set de 4: 1 caisson inférieur + 1 plateau GN 1/1 + 2 accus, cloche non incluse

	cm	↑ cm
11590	56,5 x 36	8,5

GN Rolltophaube / GN rolltop cover / GN campana rolltop / GN cloche rolltop

	cm	↑ cm	GN
11008	53 x 32,5	19	1/1

GN Rolltophaube / GN rolltop cover / GN campana rolltop / GN cloche rolltop

	cm	↑ cm	GN
11010	53 x 32,5	19	1/1

Kühlakku / cooler / acumulador de frío / accumulateur de froid

	cm	↑ cm
10791	25 x 19	2,5



18388

11538

10791

**Kühl-Akkus halten Ihre Speisen bis zu 6 Stunden kühl**  
cooler keeps the food until 6 hrs. cold

**Kühlbox „TOP FRESH SET“**

cooling plate  
bandeja de frío  
set frigifère



**3-teilig: 1 Box + 1 Tablett Ø 38 cm + 1 Kühllakku, ohne Haube**  
3 pcs. set: 1 box + 1 tray Ø 38 cm + 1 cooler, without cover  
set de 3: 1 caja + 1 bandeja Ø 38 cm + 1 enfriador, sin tapa  
set de 3: 1 caisson + 1 plateau Ø 38 cm + 1 accum. (livré sans la cloche)

	Ø cm	↑ cm	Farbe / Colour
11538	42	6	white
11533	42	6	black

**Rolltophaube / rolltop cover / campana abatible / cloche basculante**

	Ø cm	↑ cm	
18388	38	20	mit verchromtem Kugelgriff

**Kühllakku / cooler / acumulador de frío / accumulateur de froid**

	cm	↑ cm	
10791	25 x 19	2,5	



18388

09082

11101

**Kühl-Akkus halten Ihre Speisen bis zu 6 Stunden kühl**  
cooler keeps the food until 6 hrs. cold

**Thermo-Set**

thermo set  
bandeja isotérmica  
set thermo



**5-teilig: 1 Tablett tief + 1 Tablett flach + 2 Kühllakkus + 1 Rolltophaube**  
5 pcs. set: 1 deep tray + 1 tray + 2 cooler + 1 rolltop cover  
set de 5: 1 bandeja inferior + 1 bandeja + 2 acumuladores frío + campana  
set de 5: 1 plateau creux + 1 plateau plat + 2 accum. + 1 cloche rolltop

	Ø cm	↑ cm	
09082	38	24	

**Rolltophaube / rolltop cover / campana abatible / cloche basculante**

	Ø cm	↑ cm	
18388	38	20	mit verchromtem Kugelgriff

**Kühllakku / cooler / acumulador de frío / accumulateur de froid**

	cm	↑ cm	pcs.
11101	16 x 7,5	2	4



09083

11101

**Kühl-Akkus halten Ihre Speisen bis zu 6 Stunden kühl**  
cooler keeps the food until 6 hrs. cold

**Thermo-Set**

thermo set  
porta tartas refrigerado  
porte-gâteau réfrigéré



**4-teilig: 1 Tablett tief auf Fuß + 1 Tablett flach + 2 Kühllakkus**  
4 pcs. set: 1 deep tray with feet + 1 tray + 2 cooler  
set de 4: 1 bandeja honda con pie + 1 bandeja + 2 acumuladores de frío  
set de 4: 1 plateau creux avec pied + 1 plateau plat + 2 accum.

	Ø cm	↑ cm	
09083	38	14,5	

**Rolltophaube / rolltop cover / campana abatible / cloche basculante**

	Ø cm	↑ cm	
18388	38	20	mit verchromtem Kugelgriff

**Kühllakku / cooler / acumulador de frío / accumulateur de froid**

	cm	↑ cm	pcs.
11101	16 x 7,5	2	4

## Buffet & Display

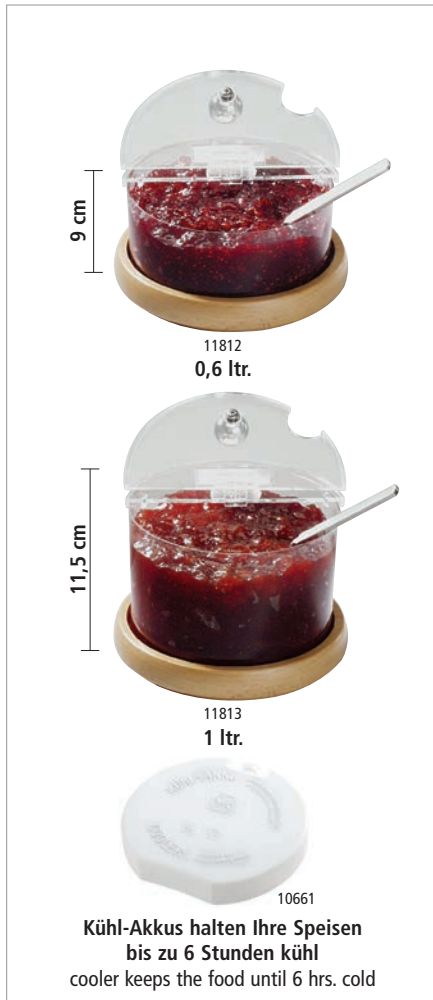

### Kühlschale Mini Holz „TOP FRESH“

cool bowl mini holz  
bol refrigerado mini madera  
bol réfrigéré MINI bois

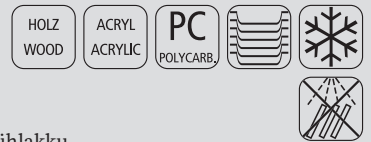

4-teilig: 1 Fuß Buchen-Holz versiegelt + 1 Schale + 1 Kühlakku  
+ 1 klappbarer Deckel mit Beschriftungsschild

4 pcs. set: 1 column with food base (beech) + 1 bowl  
+ 1 cooler + 1 cover with card, hinged

set de 4: 1 bol polycarbonato + 1 base madera  
+ 1 acum. de frío + 1 tapa con bisagra y porta etiqueta

set de 4 : 1 base en bois + 1 accum + 1 bol polycarbonate  
+ 1 couvercle à charnière avec porte-étiquette

	Ø cm	↑ cm	ltr.
11812	14	9,0	0,6
11813	14	11,5	1,0

Ersatzschale / spare bowl / recambio bol / bol de rechange

	Ø cm	↑ cm
11811	14	6,5
11816	14	9,0

Schutzdeckel mit Löffelaussparung / cover / tapa / couvercle

	Ø cm
11868	14,5

Kühlakku / cooler / acumulador de frío / accumulateur de froid

	Ø cm	↑ cm
10661	10,5	2



### Kühlschale Maxi Holz „TOP FRESH“

cool bowl maxi holz  
bol refrigerado MAXI madera  
bol réfrigéré MAXI bois

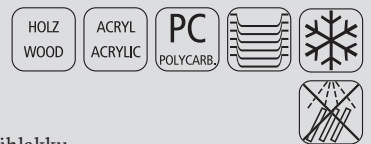

4-teilig: 1 Fuß Buchen-Holz versiegelt + 1 Schale + 1 Kühlakku  
+ 1 klappbarer Deckel mit Beschriftungsschild

4 pcs. set: 1 column with food base (beech) + 1 bowl  
+ 1 cooler + 1 cover with card, hinged

set de 4: 1 bol + 1 base madera + 1 acumulador de frío  
+ 1 tapa con bisagra y porta etiqueta

set de 4: 1 base en bois + 1 accum. + 1 bol  
+ 1 couvercle à charnière avec porte-étiquette

	Ø cm	↑ cm	ltr.
11817	22	14	2,5
11818	22	18	4,0

Ersatzschale / spare bowl / recambio bol / bol de rechange

	Ø cm	↑ cm
11846	22	8
11848	22	12

Schutzdeckel mit Löffelaussparung / cover / tapa / couvercle

	Ø cm
11878	23,5

Kühlakku / cooler / acumulador de frío / accumulateur de froid

	Ø cm	↑ cm
10777	15	2,5



### Kühlschale Mini „TOP FRESH“

cool bowl mini  
bol refrigerado MINI  
bol réfrigéré MINI



4-teilig: 1 Edelstahlgefäß matt + 1 Kühlakku + 1 Schale + 1 klappbarer Deckel mit Beschriftungsschild

4 pcs. set: 1 column satin polished finish + 1 cooler + 1 bowl + 1 cover with card, hinged

set de 4: 1 base acabado efecto satinado + 1 acumulador de frío + 1 tapa con porta etiqueta + 1 bol

set de 4: 1 base inox mat satiné + 1 accum. de froid + 1 couvercle à charnière avec porte étiquette + 1 bol

	Ø cm	↑ cm	litr.
11810	14	9,0	0,6
11815	14	11,5	1,0

#### Ersatzschale / spare bowl / recambio bol / bol de rechange

	Ø cm	↑ cm
11811	14	6,5
11816	14	9,0

#### Schutzdeckel mit Löffelaussparung / cover / tapa / couvercle

	Ø cm
11868	14,5

#### Kühlakku / cooler / acumulador de frío / accumulateur de froid

	Ø cm	↑ cm
10661	10,5	2



### Kühlschale Maxi „TOP FRESH“

cool bowl maxi  
bol refrigerado MAXI  
bol réfrigéré MAXI



4-teilig: 1 Gefäß hochglanzpoliert + 1 Kühlakku + 1 Schale + 1 klappbarer Deckel mit Beschriftungsschild

4 pcs. set: 1 column mirror polished finish + 1 cooler + 1 bowl + 1 cover with card, hinged

set de 4: 1 base pulido acabado efecto espejo + 1 acumulador de frío + 1 tapa con porta etiqueta + 1 bol

set de 4: 1 base inox poli brillant + 1 accum. + 1 récipient + 1 couvercle à charnière avec porte-étiquette

	Ø cm	↑ cm	litr.
11847	22	14	2,5
11849	22	18	4,0

#### Ersatzschale / spare bowl / recambio bol / bol de rechange

	Ø cm	↑ cm
11846	22	8
11848	22	12

#### Schutzdeckel mit Löffelaussparung / cover / tapa / couvercle

	Ø cm
11878	23,5

#### Kühlakku / cooler / acumulador de frío / accumulateur de froid

	Ø cm	↑ cm
10777	15	2,5



11845  
2,5 ltr.

11875

**Kühlschale Maxi „TOP FRESH“**

cool bowl maxi  
cuenco refrigerado MAXI  
bol réfrigéré MAXI



4-teilig: 1 Gefäß hochglanzpoliert + 1 Kühlakku + 1 Glasschale  
+ 1 klappbarer Deckel mit Beschriftungsschild

4 pcs. set: 1 column mirror polished finish + 1 cooler  
+ 1 glass bowl + 1 cover with card, hinged

set de 4: 1 base pulido acabado efecto espejo  
+ 1 acumulador de frío + 1 tapa con porta etiqueta + 1 bol vidrio

set de 4 : 1 base inox poli brillante + 1 accum.  
+ 1 bol verre + 1 couvercle à charnière avec porte-étiquette

	Ø cm	↑ cm	ltr.
11845	23	14	2,5

Schale / bowl / cuenco / bol

	Ø cm	↑ cm	ltr.
11875	23	10,5	2,5

Schutzdeckel mit Löffelaussparung / cover / tapa / couvercle

	Ø cm
11878	23,5

Kühlakku / cooler / acumulador de frío / accumulateur de froid

	Ø cm	↑ cm
10777	15	2,5



83696

83705

83920

**Schale „CASUAL MAXI“**

bowl  
cuenco  
bol



	Ø cm	↑ cm	ltr.	Farbe / Colour
83696	10	4,5	0,15	White
83698	12	5,5	0,25	White
83700	14	6,5	0,50	White
83704	20	9,2	1,80	White
83702	23	10,5	2,50	White

	Ø cm	↑ cm	ltr.	Farbe / Colour
83697	10	4,5	0,15	Black
83699	12	5,5	0,25	Black
83701	14	6,5	0,50	Black
83705	20	9,2	1,80	Black
83703	23	10,5	2,50	Black

Deckel „FLOAT“ mit Löffelaussparung / cover, with notched for spoons / tapa, con espacio para la cuchara / couvercle, avec encoche pour la louche

	Ø cm	↑ cm	fits to
83920	20,5	1,3	83704, 83705



**Glaskaraffe**

glass carafe  
jarra de vidrio  
carafe en verre



Deckel aus Edelstahl matt poliert  
lid made of matt polished stainless steel  
tapa de acero inoxidable pulido mate,  
couvreclie en acier inox poli mat

	Ø cm	↑ cm	ltr.
10721	8	25	1,0
10722	8	32	1,2



Ausgießer für tropffreies Ausgießen  
spout for drip-free pouring



**Glaskaraffe „ICEBLUE“**

glass carafe  
jarra de vidrio  
carafe en verre

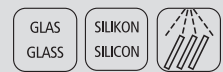

	Ø cm	↑ cm	ltr.
10723	8	30	0,8



inkl. Stopfen mit Silikondichtung  
incl. stopper with silicone gasket



**Glaskaraffe**

glass carafe  
jarra de vidrio  
carafe en verre



Deckel aus Edelstahl matt poliert, mit integriertem Auffangsieb für Kerne oder Eis  
lid made of matt polished stainless steel, with integrated strainer for cores or ice  
tapa de acero inoxidable pulido mate, con filtro integrado para los huesos o el hielo  
couvreclie en acier inox poli mat, avec filtre intégré pour les pépins ou la glace

	Ø cm	↑ cm	ltr.
10792	10	26	1,5



Deckel mit Doppelfunktion  
Lid with double function



**Glaskaraffe**

glass carafe  
jarra de vidrio  
carafe en verre



	Ø cm	↑ cm	ltr.
10745	11	25,5	1,6

## Buffet & Display



### Glaskaraffe „LINES“

glass carafe  
jarra de vidrio  
carafe en verre



	Ø cm	↑ cm	ltr.
10738	8	27	0,9



Detailansicht  
detail view „LINES“



inkl. Korkdeckel  
incl. cork cover

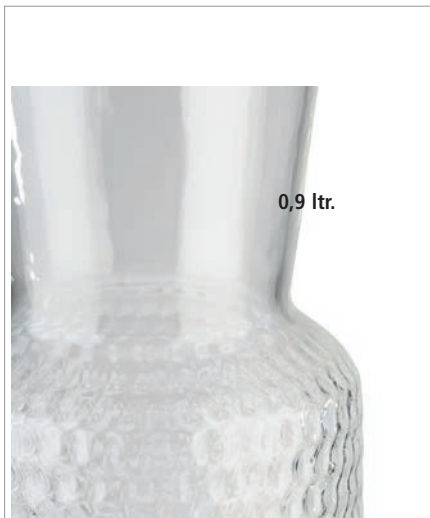

### Glaskaraffe „DOTS“

glass carafe  
jarra de vidrio  
carafe en verre



	Ø cm	↑ cm	ltr.
10739	8	27	0,9



Detailansicht  
detail view „DOTS“



inkl. Korkdeckel  
incl. cork cover



### Glaskaraffe „WABE“

glass carafe  
jarra de vidrio  
carafe en verre



	Ø cm	↑ cm	ltr.
10741	8	28	0,8



HOLZ  
WOOD

SILIKON  
SILICON

inkl. Holzkorken mit Silikondichtung  
incl. wooden cork with silicone gasket



### Glaskaraffe „DIAMOND“

glass carafe  
jarra de vidrio  
carafe en verre



	Ø cm	↑ cm	ltr.
10742	8	28	0,8



HOLZ  
WOOD

SILIKON  
SILICON

inkl. Holzkorken mit Silikondichtung  
incl. wooden cork with silicone gasket





**Glaskaraffe „RINGS“**

glass carafe  
jarra de vidrio  
carafe en verre



	∅ cm	↑ cm	ltr.
10743	8	28	0,8



HOLZ  
WOOD

SILIKON  
SILICON

inkl. Holzkorken mit Silikondichtung  
incl. wooden cork with silicone gasket



**Flasche „STRIPES“**

bottle  
botella  
bouteille



	∅ cm	↑ cm	ltr.
10748	9	28,5	1



**Flasche „STRIPES“**

bottle  
botella  
bouteille



	∅ cm	↑ cm	ltr.
10749	9	28,5	1



**Kühlkaraffe, 3-teilig „COOL“**

cooling carafe, 3 pcs. set  
jarra fría, set de 3  
pichet rafraichisseur, set 3



1 Glaskaraffe mit Edelstahl-Ausgießer, öffnet und schließt selbstständig  
+ 1 verchromter Fuß + 1 Kühlakku, werden bis zu 4 Stunden gekühlt  
1 glass carafe with stainless steel pourer, open / closing autonomous  
+ 1 chrome plated base + 1 cooling pack, up to 4 hours cooled beverages  
1 botella de vidrio con vertedor inox y silicona, con autocierre  
+ 1 base cromada + 1 placa de frío que mantiene las bebidas frescas hasta unas 4 horas  
pichet en verre avec insert verseur inox et silicone, fermeture automatique  
+ socle chromé + accumulateur de froid pour maintenir les boissons froides jusqu'à 4 heures

	∅ cm	↑ cm	ltr.
10762	16	27	1,4

Glasflasche / glass carafe / jarra de vidrio / pichet verre

	∅ cm	↑ cm
10761	16	26

Kühlakku rund, schwarz / cooler round, black / cooler / accumulateur de froid, noir

	∅ cm	↑ cm
10752	10,5	2

## Buffet & Display



### Glaskaraffe

glass carafe  
jarra  
pichet en verre



der Deckel öffnet sich beim Ausgießen automatisch  
cover opens automatically while pouring  
la tapa se abre automáticamente durante el vertido  
le couvercle s'ouvre seul pendant le service, résistant à la chaleur

	Ø cm	↑ cm	ltr.
10766	9,5	29	1



### Glaskaraffe

glass carafe  
jarra  
pichet verre



Deckel aus Edelstahl matt poliert  
stainless steel cover  
tapa de acero inoxidable  
couvercle inox



Ausgießer für tropffreies ausgießen  
spout for drip-free pouring

	Ø cm	↑ cm	ltr.
10764	9,5	27	1,5



### Saft- / Wasserkanne

juice / water pitcher  
jarra de zumo / agua  
pichet à eau ou jus de fruit



mit Eiswasser-Röhre  
with water ice tube  
con tubo para hielo  
avec tube à glaçons plongeant pour réfrigérer

	cm	↑ cm	ltr.
10769	19 x 13	27	2,8



### Saftkanne

juice pitcher  
jarra de zumo  
pichet à jus de fruit



mit Eiswasser-Röhre  
with water ice tube  
con tubo para hielo  
avec tube à glaçons plongeant pour réfrigérer

	Ø cm	↑ cm	ltr.
10770	18	29	3



**Saftkanne**  
juice pitcher  
jarra de zumo  
pichet à jus de fruit



	Ø cm	↑ cm	ltr.
10775	12	26	2



**Saftkanne**  
juice pitcher  
jarra de zumo  
pichet à jus de fruit



	Ø cm	↑ cm	ltr.
10776	14	29	2,5



**Pitcher**  
pitcher  
jarra  
pichet



	Ø cm	↑ cm	ltr.
93105	13	21	1,5



**Karaffe / Kanne**  
bottle  
botella  
bouteille



**Schraubdeckel mit aromadichtem Verschluss**  
screwed lid, aroma-tight  
tapón de rosca, impide la fuga de aromas  
bouchon à visser, ne laisse pas passer les arômes

	Ø cm	↑ cm	ltr.	Farbe / Colour
10771	11	30	1,6	
10772	11	30	1,6	
10773	11	30	1,6	
10774	11	30	1,6	

## Buffet & Display



### Kühlbox „FROSTY“

bottle cooler  
enfriador de botellas  
rafraichisseur de bouteilles

mit herausnehmbarem Einsatz für 4 Flaschen

with removable insert for 4 bottles  
con inserto extraíble para 4 botellas  
avec insert amovible pour 4 bouteilles



**Abb. ohne Einsatz**  
illustration without insert

	cm	↑ cm	ltr.	hole ø cm
93230	27 x 27	15	7,5	11



### Wein- / Sektkühler

wine / champagne bowl  
cubitera para vino y cava  
seau à vin ou champagne

gehämmerte Oberfläche mit 2 seitlichen Eingriffen

hammered surface with 2 handles on the side  
superficie martillada con 2 asas  
surface martelée avec 2 poignées



	cm	↑ cm	ltr.	Farbe / Colour
36111	30 x 23,5	23	7	copper-look



### Wein- / Sektkühler

wine / champagne bowl  
cubitera para vino y cava  
seau à vin ou champagne

gehämmerte Oberfläche mit 2 seitlichen Eingriffen

hammered surface with 2 handles on the side  
superficie martillada con 2 asas  
surface martelée avec 2 poignées



	cm	↑ cm	ltr.	Farbe / Colour
36112	30 x 23,5	23	7	gunmetal-look



### Getränkewanne „TIN“

beverage tub  
barreño botellines  
bassine à glace

Metall verzinkt, mit Kunststoffeinsatz

galvanised metal, with plastic insert  
metal galvanizado, con inserto de plástico  
métal galvanisé, avec insert en plastique



	Ø cm	↑ cm	ltr.	Farbe
36100	40 x 28	22	11	copper-look
36101	40 x 28	22	11	black-metal-look



mit Kunststoffeinsatz  
with plastic insert  
con inserto de plástico  
avec insert en plastique



Kreidestift zum Beschriften  
chalk marker for writing  
S. 312



10328

**Milch- / Universalkanne**

milk / water jug  
jarra leche / agua  
pichet à eau / lait



**außen hochglanzpoliert, innen matt poliert**  
outside mirror polished finish, inside satin polished finish  
exterior brillante, interior satinado  
extérieur brillant, intérieur mat satiné

	Ø cm	↑ cm	ltr.
10328	8,0	10,0	0,35
10329	9,0	11,5	0,60
10330	10,5	13,0	0,80
10331	12,0	16,5	1,30
10332	13,5	18,0	2,00



10334

**Milch-/Universalkanne „ANTIHAFT“**

non stick jug  
jarra antiadherente  
pichet antiadhésif



**PTFE-antihftbeschichtet, perfekt für die Herstellung von Milchschaum**  
PTFE coated, for baristas frothing hot milk  
revestimiento PTFE, ideal para espume de leche  
revêtement PTFE, idéal pour faire mousser le lait

	Ø cm	↑ cm	ltr.
10334	8,0	10,0	0,35
10335	9,0	11,5	0,6
10336	10,5	13,0	0,8



**Teebrühsieb**

snap mesh tea ball  
infusor de té, pinza con malla  
boule à thé avec pince



**matt poliert, mit feinem Sieb, aufklappbar**  
satin polished finish, with fine mesh, hinged  
acabado pulido efecto satinado, con malla fina, con bisagra  
inox mat, maille fine, avec charnière

	Ø cm	→ cm
74750	4,5	15,5



0,3 ltr.

**Teekanne „ASIA“**

teapot  
tetera  
théière



**aus Gusseisen, innen emailliert, hält den Tee lange warm, kein nachbittern, ideal für zwei Tassen**  
made of cast iron, keeps the tea warm for a long time, no bitterness, ideal for two cups  
hecho de hierro fundido, mantiene el té caliente durante mucho tiempo, sin amargar, ideal para dos tazas  
en fonte, maintient le thé chaud pendant longtemps, pas d'amertume, idéal pour deux tasses

	cm	↑ cm	ltr.
10990	12,5 x 11	12,5	0,3

# BEVERAGE DISPENSERS



## Getränkespender „OLD FASHIONED“

beverage dispenser  
dispensador de bebidas  
distributeur de boissons



dicke, stabile Wände, weite Öffnung für große Zutaten, Gestell schwarz  
thick, stable walls, a wide opening for large ingredients, black stand  
tiene paredes gruesas y estables, amplia abertura para ingredientes grandes, soporte negro  
des murs épais et stables, large ouverture pour de grands ingrédients, support noir

	Ø cm	↑ cm	ltr.	
10409	27	50,5	7	inkl. Gestell / incl. stand

Ersatz-Gestell zu Getränkenspender / stand for beverage dispenser / soporte de recambio para el dispensador de bebidas / support de remplacement pour le distributeur de boissons

	Ø cm	↑ cm	
10410	27	31,5	

Ersatz-Glas zu Getränkenspender ohne Zapfhahn / replacement glass for beverage dispenser without tap / cristal de recambio para el dispensador de bebidas sin grifo / vitre de rechange pour le distributeur de boissons sans robinet

	Ø cm	↑ cm	ltr.
10411	19	36,5	7

Ersatz-Zapfhahn zu Getränkenspender / replacement tap for beverage dispenser

10718



## Getränkespender „ASIA“

beverage dispenser  
dispensador de bebidas  
distributeur de boissons



dicke, stabile Wände, weite Öffnung für große Zutaten, Fuß und Deckel aus Holz  
thick, stable walls, a wide opening for large ingredients, wooden stand and lid  
tiene paredes gruesas y estables, amplia abertura para ingredientes grandes, soporte y tapa de madera  
des murs épais et stables, large ouverture pour de grands ingrédients, support et couvercle en bois

	Ø cm	↑ cm	ltr.	
10403	24,5	45,5	7	inkl. Gestell / incl. stand

Ersatz-Fuß zu Getränkenspender mit Anti-Rutsch-Füßchen / base to beverage dispenser with non slip feet / soporte de recambio para el dispensador de bebidas con pies antideslizantes / support de remplacement pour le distributeur de boissons avec pieds antidérapants

	Ø cm	↑ cm	
10404	24,5	15	

Ersatz-Deckel zu Getränkenspender / replacement lid for beverage dispenser / tapa de recambio para el dispensador de bebidas / couvercle de rechange pour le distributeur de boissons

	Ø cm	↑ cm	
10405	14,0	5	



7 ltr.

**Getränkespender „ELEMENT“**

beverage dispenser  
dispensador de bebidas  
distributeur de boissons



**dicke, stabile Wände, weite Öffnung für große Zutaten, Fuß und Deckel aus Beton**  
thick, stable walls, a wide opening for large ingredients, stand and lid made of concrete  
tiene paredes gruesas y estables, amplia abertura para ingredientes grandes, soporte y tapa de hormigón  
des murs épais et stables, large ouverture pour de grands ingrédients, support et couvercle en béton

	Ø cm	↑ cm	litr.	
10400	22	45	7	inkl. Gestell / incl. stand

**Ersatz-Fuß zu Getränkenspender mit Anti-Rutsch-Füßchen** / base to beverage dispenser with non slip feet / soporte de recambio para el dispensador de bebidas con pies antideslizantes / support de remplacement pour le distributeur de boissons avec pieds antidérapants

	Ø cm	↑ cm
10401	22	17

**Ersatz-Deckel zu Getränkenspender** / replacement lid for beverage dispenser / tapa de recambio para el dispensador de bebidas / couvercle de rechange pour le distributeur de boissons

	Ø cm	↑ cm
10402	14	2,5



6 ltr.

**Getränkespender „GINGER“**

beverage dispenser  
dispensador de bebidas  
distributeur de boissons



**weite Öffnung für große Zutaten, 1 Kühlakku im Standfuß**  
wide opening for large ingredients, 1 cooler in the base  
amplia abertura para ingredientes grandes, 1 acumulador de frío en la base  
large ouverture pour de grands ingrédients, 1 accumulateur de froid dans le socle

	Ø cm	↑ cm	litr.	
10406	20	49,5	6	inkl. Gestell / incl. stand

**Ersatz-Fuß zu Getränkenspender mit Anti-Rutsch-Füßchen**  
base to beverage dispenser with non slip feet  
soporte de recambio para el dispensador de bebidas con pies antideslizantes  
support de remplacement pour le distributeur de boissons avec pieds antidérapants

	Ø cm	↑ cm
10407	18	13,5

**Ersatz-Deckel zu Getränkenspender** / replacement lid for beverage dispenser / tapa de recambio para el dispensador de bebidas / couvercle de rechange pour le distributeur de boissons

	Ø cm	↑ cm
10408	20	7,5

**Kühlakku** / cooler / acumulador de frío / accumulateur de froid

	Ø cm	↑ cm
10777	15	2,5

**Behälter inkl. Zapfhahn** / container incl. tap / recipiente con grifo / récipient avec robinet

	litr.
10703	6

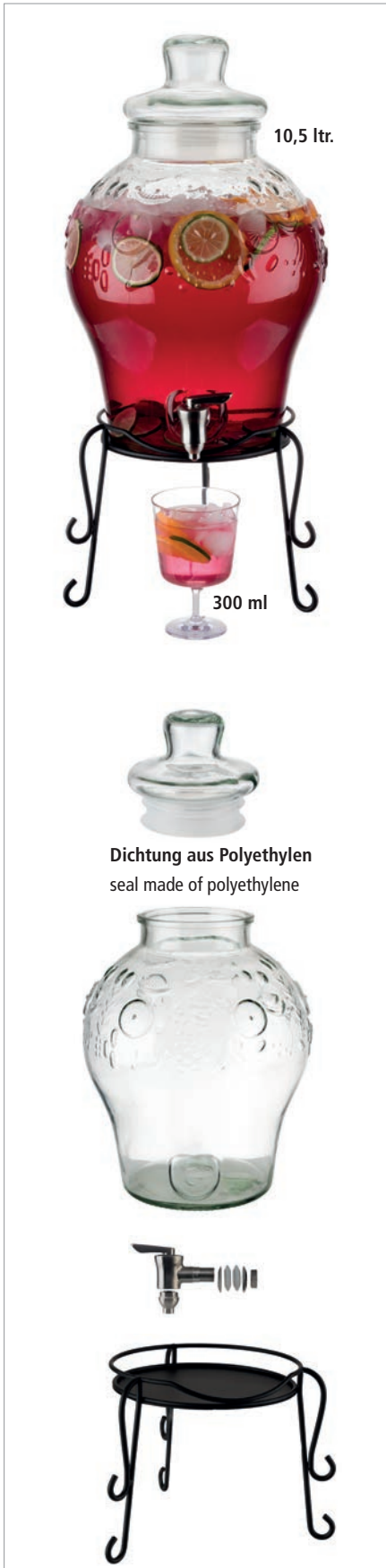

10,5 ltr.

300 ml

Dichtung aus Polyethylen  
seal made of polyethylene

300 ml

Getränkespender „FRUITS“

beverage dispenser  
dispensador de bebidas  
distributeur de boissons



dicke, stabile Wände, weite Öffnung für große Zutaten, Gestell schwarz  
thick, stable walls, a wide opening for large ingredients, black stand  
tiene paredes gruesas y estables, amplia abertura para ingredientes grandes, soporte negro  
des murs épais et stables, large ouverture pour de grands ingrédients, support noir

	Ø cm	↑ cm	ltr.	
10415	25	58	10,5	inkl. Gestell / incl. stand

Trinkglas „BEACH“

drinking glass / vaso / verre



	Ø cm	↑ cm	ltr.	VE
10505	8,5	13,5	0,3	48

Ersatzteile Getränkenspender „FRUITS“

spare parts beverage dispenser  
recambios dispensador de bebidas  
pièces distributeur de boissons

Ersatz-Deckel zu Getränkenspender „FRUITS“

replacement glass for beverage dispenser / cristal de recambio  
para el dispensador de bebidas / vitre de rechange pour le  
distributeur de boissons



	Ø cm	↑ cm
10418	14	12

Ersatz-Glas zu Getränkenspender „FRUITS“ inkl. Deckel, ohne Zapfhahn

replacement glass for beverage dispenser without tap  
cristal de recambio para el dispensador de bebidas sin grifo  
vitre de rechange pour le distributeur de boissons sans robinet

	Ø cm	↑ cm	ltr.
10417	25	42	10,5

Ersatz-Zapfhahn zu Getränkenspender

replacement tap for beverage dispenser  
grifo de recambio para el dispensador de bebidas  
robinet de rechange pour le distributeur de boissons



10718
-------

Ersatz-Gestell zu Getränkenspender

stand for beverage dispenser  
soporte de recambio para el dispensador de bebidas  
support de remplacement pour le distributeur de boissons



	Ø cm	↑ cm
10416	26	19

Trinkglas „OLD FASHIONED“

drinking cup  
vaso  
gobelet



	Ø cm	↑ cm	ltr.	VE
10520	7	12,5	0,3	6





4,5 ltr.

300 ml

### Getränkespender „FRESH WHITE“

beverage dispenser  
dispensador de bebidas  
distributeur de boissons

Behälter mit Edelstahlzapfhahn und Holzdeckel, stabiles Glas,  
inkl. weißem Holzstandfuß und Kork-Untersetter

container with stainless steel tap and wooden cover, solid glass,  
incl. white wooden base and cork coaster

recipiente con grifo de acero inoxidable y tapa de madera, cristal sólido,  
incl. pie de madera blanca y posavasos de corcho

réceptier avec robinet en acier inox et couvercle en bois, verre robuste,  
incl. pied en bois blanc et soucoupes de liège

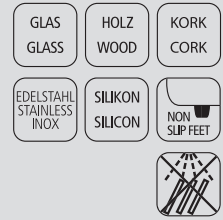

	cm	↑ cm	ltr.	
10420	23 x 23	56,5	4,5	inkl. Gestell / incl. stand

### Trinkbecher „CRYSTAL“ drinking cup / vaso / gobelet



	Ø cm	↑ cm	ltr.	VE
10501	8	12,5	0,3	48

### Ersatzteile Getränkspender „FRESH WHITE“

spare parts beverage dispenser  
recambios dispensador de bebidas  
pièces distributeur de boissons

Ersatz-Deckel zu Getränkspender „FRESH WHITE“  
replacement lid for beverage dispenser  
tapa de recambio para el dispensador de bebidas  
couvercle de rechange pour le distributeur de boissons



	Ø cm	↑ cm	Farbe / Colour
10423	11,5	1,5	_____

Ersatz-Glas zu Getränkspender „FRESH WHITE“, inkl. Zapfhahn  
replacement glass for beverage dispenser with tap  
cristal de recambio para el dispensador de bebidas con grifo  
vitre de rechange pour le distributeur de boissons avec robinet



	Ø cm	↑ cm	ltr.
10422	15,5	42,0	4,5

Ersatz-Untersetter aus Kork zu Getränkspender „FRESH WHITE“  
replacement cork coaster for beverage dispenser  
posavasos de corcho de recambio para el dispensador de bebidas  
soucoupes de liège de rechange pour le distributeur de boissons



	Ø cm	↑ cm
10424	16,5	1,5

Ersatz-Gestell zu Getränkspender „FRESH WHITE“  
stand for beverage dispenser  
soporte de recambio para el dispensador de bebidas  
support de remplacement pour le distributeur de boissons



	cm	↑ cm	Farbe / Colour
10421	23 x 23	14	_____



Glas inkl.  
Zapfhahn





**Getränkespender „FRESH WOOD“**

beverage dispenser  
dispensador de bebidas  
distributeur de boissons

Behälter mit Edelstahlzapfhahn und Korkdeckel, stabiles Glas,  
inkl. Holzstandfuß und Kork-Untersetzer

container with stainless steel tap and cork cover, solid glas,  
incl. wooden base and cork coaster

recipiente con grifo de acero inoxidable y tapa de corcho, cristal sólido,  
incl. pie de madera y posavasos de corcho

réipient avec robinet en acier inox et couvercle de liège, verre robuste,  
incl. pied en bois et soucoupes de liège

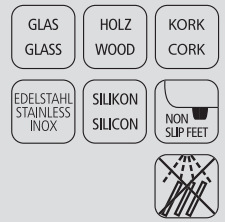

	cm	↑ cm	ltr.	
10430	23 x 23	56,5	4,5	inkl. Gestell / incl. stand

**Trinkbecher „CRYSTAL“**  
drinking cup / vaso / gobelet



	Ø cm	↑ cm	ltr.	VE
10501	8	12,5	0,3	48

**Tropfenschale**  
drip tray  
aro anti-goteo  
anneau coupe-gouttes



	Ø cm	↑ cm	Farbe / Colour
10851	9,5	1,5	

**Ersatzteile Getränkspender „FRESH WOOD“**

spare parts beverage dispenser  
recambios dispensador de bebidas  
pièces distributeur de boissons

**Ersatz-Deckel zu Getränkspender „FRESH WOOD“**  
replacement lid for beverage dispenser  
tapa de recambio para el dispensador de bebidas  
couvercle de rechange pour le distributeur de boissons



	Ø cm	↑ cm	Farbe / Colour
10428	11,5	1,5	

**Ersatz-Glas zu Getränkspender „FRESH WOOD“, inkl. Zapfhahn**  
replacement glass for beverage dispenser with tap  
cristal de recambio para el dispensador de bebidas con grifo  
vitre de rechange pour le distributeur de boissons avec robinet



	Ø cm	↑ cm	ltr.
10422	15,5	42,0	4,5

**Ersatz-Untersetzer aus Kork zu Getränkspender „FRESH WOOD“**  
replacement cork coaster for beverage dispenser  
posavasos de corcho de recambio para el dispensador de bebidas  
soucoupes de liège de rechange pour le distributeur de boissons



	Ø cm	↑ cm
10424	16,5	1,5

**Ersatz-Gestell zu Getränkspender „FRESH WOOD“**  
stand for beverage dispenser  
soporte de recambio para el dispensador de bebidas  
support de remplacement pour le distributeur de boissons



	cm	↑ cm	Farbe / Colour
10426	23 x 23	14	



7,5 ltr.

300 ml



7,5 ltr.

Glas inkl. Zapfhahn



### Getränkespender „NORDIC WHITE“

beverage dispenser  
dispensador de bebidas  
distributeur de boissons

Behälter mit Edelstahlzapfhahn und Holzdeckel, stabiles Glas,  
inkl. weißem Holzstandfuß und Kork-Untersetzer

container with stainless steel tap and wooden cover, solid glass,  
incl. white wooden base and cork coaster

recipiente con grifo de acero inoxidable y tapa de madera, cristal sólido,  
incl. pie de madera blanca y posavasos de corcho

réceptif avec robinet en acier inox et couvercle en bois, verre robuste,  
incl. pied en bois blanc et soucoupes de liège

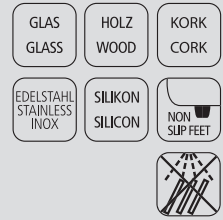

	cm	↑ cm	ltr.	
10425	23 x 23	60,5	7,5	inkl. Gestell / incl. stand

### Trinkbecher „CRYSTAL“ drinking cup / vaso / gobelet



	Ø cm	↑ cm	ltr.	VE
10501	8	12,5	0,3	48

### Tropfenschale drip tray aro anti-goteo anneau coupe-gouttes



	Ø cm	↑ cm	Farbe / Colour
10851	9,5	1,5	█

### Ersatzteile Getränkspender „NORDIC WHITE“

spare parts beverage dispenser  
recambios dispensador de bebidas  
pièces distributeur de boissons

Ersatz-Deckel zu Getränkspender „NORDIC WHITE“  
replacement lid for beverage dispenser  
tapa de recambio para el dispensador de bebidas  
couvercle de rechange pour le distributeur de boissons avec robinet



	Ø cm	↑ cm	Farbe / Colour
10423	11,5	1,5	█

Ersatz-Glas zu Getränkspender „NORDIC WHITE“, inkl. Zapfhahn  
replacement glass for beverage dispenser with tap  
cristal de recambio para el dispensador de bebidas con grifo  
vitre de rechange pour le distributeur de boissons avec robinet



	Ø cm	↑ cm	ltr.
10427	17	46	7,5

Ersatz-Untersetzer aus Kork zu Getränkspender „NORDIC WHITE“  
replacement cork coaster for beverage dispenser  
posavasos de corcho de recambio para el dispensador de bebidas  
soucoupes de liège de rechange pour le distributeur de boissons



	Ø cm	↑ cm
10424	16,5	1,5

Ersatz-Gestell zu Getränkspender „NORDIC WHITE“  
stand for beverage dispenser  
soporte de recambio para el dispensador de bebidas  
support de remplacement pour le distributeur de boissons



	cm	↑ cm	Farbe / Colour
10421	23 x 23	14	█



7,5 ltr.

300 ml

7,5 ltr.

Glas inkl. Zapfhahn

**Getränkespender „NORDIC WOOD“**

beverage dispenser  
dispensador de bebidas  
distributeur de boissons

Behälter mit Edelstahlzapfhahn und Korkdeckel, stabiles Glas, inkl. Holzstandfuß und Kork-Untersetzer

container with stainless steel tap and cork cover, solid glas, incl. wooden base and cork coaster

recipiente con grifo de acero inoxidable y tapa de corcho, cristal sólido, incl. pie de madera y posavasos de corcho

réipient avec robinet en acier inox et couvercle de liège, verre robuste, incl. pied en bois et soucoupes de liège

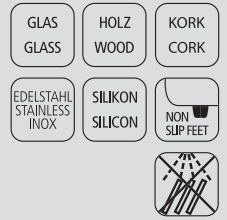

	cm	↑ cm	ltr.	
10435	23 x 23	60,5	7,5	inkl. Gestell / incl. stand

**Trinkbecher „CRYSTAL“**  
drinking cup / vaso / gobelet



	Ø cm	↑ cm	ltr.	VE
10501	8	12,5	0,3	48

**Ersatzteile Getränkspender „NORDIC WOOD“**

parts beverage dispenser  
recambios dispensador de bebidas  
pièces distributeur de boissons

**Ersatz-Deckel zu Getränkspender**  
replacement lid for beverage dispenser  
tapa de recambio para el dispensador de bebidas  
couvercle de rechange pour le distributeur de boissons



	Ø cm	↑ cm
10428	11,5	1,5

**Ersatz-Glas zu Getränkspender „NORDIC WOOD“, inkl. Zapfhahn**  
replacement glass for beverage dispenser with tap  
cristal de recambio para el dispensador de bebidas con grifo  
vitre de rechange pour le distributeur de boissons avec robinet



	Ø cm	↑ cm	ltr.
10427	17	46	7,5

**Ersatz-Untersetzer aus Kork zu Getränkspender „NORDIC WOOD“**  
replacement cork coaster for beverage dispenser  
posavasos de corcho de recambio para el dispensador de bebidas  
soucoupes de liège de rechange pour le distributeur de boissons



	Ø cm	↑ cm
10424	16,5	1,5

**Ersatz-Gestell zu Getränkspender „NORDIC WOOD“**  
stand for beverage dispenser  
soporte de recambio para el dispensador de bebidas  
support de remplacement pour le distributeur de boissons



	cm	↑ cm	Farbe / Colour
10426	23 x 23	14	



**Getränkespender**  
beverage dispenser  
dispensador de bebidas  
distributeur de boissons



**dicke, stabile Wände, weite Öffnung für große Zutaten**

thick, stable walls, a wide opening for large ingredients

tiene paredes gruesas y estables, amplia abertura para ingredientes grandes

des murs épais et stables, large ouverture pour de grands ingrédients

	Ø cm	↑ cm	ltr.
10855	20	30,5	7



**Tropfenschale (2-tlg.)**  
drip tray  
aros anti-goteo  
anneaux coupe-gouttes



	Ø cm	↑ cm	Farbe / Colour
10851	9,5	1,5	White
10853	9,5	1,5	Black



**Trinkbecher „CRYSTAL“**  
drinking cups  
vasos  
gobelets

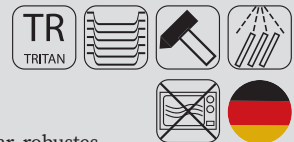

**Kristallglas-Optik, vielseitig einsetzbar, robustes, unzerbrechliches Material, ideal in sensiblen Bereichen wie Pool, Spa, Beach und Wellness einzusetzen, BPA-frei**

crystal-glass-look, can be used in versatile ways, a solide and unbreakable material, ideal to be used in pool, spa, beach and wellness areas, bpa-free

look de vidrio, se pueden utilizar de muchas maneras diferentes, material sólido e irrompible, ideal para el uso en áreas como piscina, spa, playa y bienestar, libre de BPA

look de verre de cristal, peuvent être utilisés de différentes façons, matériau robuste et incassable, idéal pour une utilisation dans des zones comme la piscine, le spa, la plage et le bien-être, sans BPA

	Ø cm	↑ cm	ltr.	VE
10500	7	9,5	0,15	48
10501	8	12,5	0,30	48
10502	9	15,5	0,50	48



12 ltr.

**Kaffeedispenser „ROYAL“**

coffee dispenser  
dispensador de café  
distributeur de café



hochglanzpoliert, für warme Getränke, stabil und standfest, inkl. 1 Brennpastenbehälter  
mirror polished finish, for warm drinks, solid and stable, incl. 1 burner holder  
acabado brillante para bebidas calientes, sólido y estable, incluye un calentador  
brillant, pour boissons chaudes, avec 1 brûleur, robuste et stable

	cm	↑ cm	ltr.
11667	28 x 28	65	12



10,5 ltr.

**Kaffeedispenser „HAPPY HOUR“**

coffee dispenser  
dispensador de café  
distributeur de café



hochglanzpoliert, für warme Getränke, stabil und standfest, inkl. 1 Brennpastenbehälter  
mirror polished finish, for warm drinks, solid and stable, incl. 1 burner holder  
acabado pulido brillante para bebidas calientes, sólido y estable, incluye un calentador  
brillant, pour boissons chaudes, avec 1 brûleur, robuste et stable

	cm	↑ cm	ltr.
11672	31 x 33,5	54,5	10,5

Hahn / tap / grifo / robinet

11671

Elektro-Heizelement / heating unit / resistencia / résistance

	cm	↑ cm
12287	21 x 20	6



**Saftdispenser „TOP FRESH“**

juice dispenser  
dispensador de zumo  
distributeur à jus de fruit



hochglanzpoliert, Kühlung durch 2 Kühlakkus von oben und unten  
mirror polished finish, cooling with 2 cooling elements from the top and base

base inox brillante, con 2 acum. de frio, 1 arriba y 1 en la base

base inox poli brillant, 2 plaques de froid (1 dans le couvercle, 1 dans le socle)

	cm	↑ cm	ltr.
10800	21 x 32	43	4
10700	23 x 35	52	6



**Saftdispenser DUO „TOP FRESH“**

juice dispenser  
dispensador de zumo  
distributeur à jus de fruit



hochglanzpoliert, Kühlung durch 2 Kühlakkus von oben und unten

mirror polished finish, cooling with 2 cooling elements from the top and base

base inox brillante, con 2 acum. de frio, 1 arriba y 1 en la base

base inox poli brillant, 2 plaques de froid (1 dans le couvercle, 1 dans le socle)

	cm	↑ cm	ltr.
10720	42 x 32	52	2 x 6



**Saft- und Milchdispenser MIX „TOP FRESH“**

juice and milk dispenser  
dispensador mixto zumo y leche  
distributeur mixte à lait et à jus de fruit



6 Liter Saftbehälter, 5 Liter Milchkanne, Kühlung durch Kühlakkus von oben und unten

6 liters juice container, 5 liters milkcan, cooling with cooling elements from the top and base

recipiente de zumo 6 litros, recipiente de leche 5 litros, 2 enfriadores récipient à jus 6 l, récipient à lait 5 l, plaques de froid

	cm	↑ cm	ltr.
10760	42 x 35	52	6 + 5



**Saftdispenser WOOD „TOP FRESH“**

juice dispenser  
dispensador de zumo  
distributeur à jus de fruit



Buchen-Holz versiegelt, Kühlung durch 2 Kühlakkus von oben und unten (nur 10730)

beech wood, waterproof, cooling with 2 cooling elements from the top and base (only 10730)

madera de haya con tratamiento anti humedad, 2 acumuladores de frío, 1 en la base y 1 en la tapa (solamente 10730)

bois de hêtre traité anti-humidité, 2 plaques de froid, 1 dans le couvercle, 1 dans le socle (seulement 10730)

	cm	↑ cm	ltr.
10820	21 x 31	44	4
10730	23 x 35	52	6



**1) Deckel / cover / tapa / couvercle**

für ltr. / for ltr. / para ltr. / pour ltr.

10701	6
10801	4

**2) Kühlakku / cooler / acumulador de frío / accumulateur de froid**

für ltr. / for ltr. / para ltr. / pour ltr.

10777	4 / 6
-------	-------

**3) Behälter inkl. Zapfhahn / container incl. tap**  
recipiente con grifo / récipient avec robinet

für ltr. / for ltr. / para ltr. / pour ltr.

10703	6
10803	4

**3) Behälter ohne Zapfhahn / container without tap**  
recipiente sin grifo / récipient sans robinet

für ltr. / for ltr. / para ltr. / pour ltr.

10704	6
10804	4

**4) Non-Drip Hahn / non-drip tap / grifo anti-goteo / robinet anti-goutte**

für ltr. / for ltr. / para ltr. / pour ltr.

10707	6
10807	4

**5) Dichtungsring / sealing ring / arandela / rondelle**

für ltr. / for ltr. / para ltr. / pour ltr.

10608	4 / 6
-------	-------

**6) Einsatz / insert / aro inox / cercle inox**

für ltr. / for ltr. / para ltr. / pour ltr.

10708	6
10808	4

**7) Standfuß 18/10 Edelstahl / column 18/10 stainless steel**  
base inox 18/10 / socle inox 18/10

für ltr. / for ltr. / para ltr. / pour ltr.

10709	6
10809	4

**8) Tropfgitter 18/10 Edelstahl / drip lattice 18/10 stainless steel**  
rejilla recoge gotas 18/10 / grille ramasse-gouttes 18/10

für ltr. / for ltr. / para ltr. / pour ltr.

10712	6
10713	DUO
10812	4

**9) Bodenplatte 18/10 Edelstahl / footing 18/10 stainless steel**  
base de 18/10 acero / socle inox 18/10

für ltr. / for ltr. / para ltr. / pour ltr.

10710	6
10711	DUO / 6 + 6
10814	4

**Zubehör / Reinigungsset - für die regelmäßige Reinigung**

**1x Dichtung, 2x Dichtungsring (transparent), 1x Dichtungsring (s / w)**  
1x seal, 2x sealing ring (transparent), 1x sealing ring (b / w)

10714	für Zapfhahn 10707
10715	für Zapfhahn 10807
10716	für Zapfhahn 10907
10717	für Zapfhahn 10867





**Saftdispenser WOOD DUO „TOP FRESH“**

juice dispenser  
dispensador de zumo  
distributeur à jus de fruit

HOLZ  
WOOD

EDELSTAHL  
STAINLESS  
INOX  
18/8



SAN  
KUNSTSTOFF

**Buchen-Holz versiegelt,  
Kühlung durch 2 Kühllakkus von oben und unten**

beech wood, waterproof, cooling with 2 cooling elements  
from the top and base

madera de haya con tratamiento anti humedad, 2 acumuladores  
de frio (1 en la base y 1 en la tapa)

bois de hêtre traité anti-humidité, 2 plaques de froid (1 dans le  
couvercle, 1 dans le socle)

	cm	↑ cm	ltr.
10740	42 x 35	52	2 x 6



**Saft- und Milchdispenser WOOD DUO „TOP FRESH“**

juice and milk dispenser  
dispensador de zumo  
distributeur à jus de fruit

HOLZ  
WOOD

EDELSTAHL  
STAINLESS  
INOX  
18/8



SAN  
KUNSTSTOFF

**6 Liter Saftbehälter, 5 Liter Milchkanne, Kühlung durch  
Kühllakkus von oben und unten, Buchen-Holz versiegelt**

6 liters juice container, 5 liters milkcan, cooling with cooling  
elements from the top and base, beech wood, waterproof

madera de haya con tratamiento anti humedad, acumuladores  
de frio, enfriador en la base

bois de hêtre traité anti-humidité, plaques dans le socle

	cm	↑ cm	ltr.
10765	42 x 35	52	6 + 5



hot  
price

9,5 ltr.

einklappbare FüÙe  
foldable feet

**Iso-Dispenser**

insulated dispenser  
dispensador isotérmico  
distributeur de boisson isothermique

ABS  
KUNSTSTOFF

EDELSTAHL  
STAINLESS  
INOX  
18/8

**für heiÙe und kalte Getränke**

for hot and cold drinks

para bebidas frías y calientes

pour boissons chaudes ou froides

	Ø cm	↑ cm	ltr.
10788	24	42	9,5

Hahn / tap / grifo / robinet

10789



7 ltr.

**Getränkespender**

beverage dispenser  
dispensador de bebidas  
distributeur de boissons

GLAS  
GLASS

EDELSTAHL  
STAINLESS  
INOX



**dicke, stabile Wände, weite Öffnung für große Zutaten**

thick, stable walls, a wide opening for large ingredients

tiene paredes gruesas y estables, amplia abertura para  
ingredientes grandes

des murs épais et stables, large ouverture pour de grands ingrédients

	Ø cm	↑ cm	ltr.
10855	20	30,5	7

## Buffet & Display



### Saftdispenser „SUNDAY“

juice dispenser  
dispensador de zumo  
distributeur à jus de fruit



**matt poliert, Kühlung durch 2 Kühlakkus von oben und unten**

satin polished finish, cooling with 2 cooling elements from the top and base

acabado pulido brillante, 2 acum. de frío (1 en la base y 1 en la tapa)

inox mat, 2 accus. de froid (1 socle et 1 couvercle)

	cm	↑ cm	ltr.
10860	21 x 35	48	6



### Saft- / Milchdispenser „SUNDAY“

juice and milk dispenser  
dispensador mixto zumo y leche  
distributeur mixte à lait et à jus de fruit



**matt poliert, Behälter gefrostet, Kühlung durch 2 Kühlakkus von oben und unten**

satin polished finish, canister frosted look, cooling with 2 cooling elements from the top and base

inox acabado pulido mate, 1 recipiente policarbonato aspecto glaseado, 2 enfriadores en la base y en la tapa

inox mat, récipient polycarbonate opaque, 2 accus. de froid dans le socle et dans le couvercle

	cm	↑ cm	ltr.
10865	21 x 35	48	6



### Saftdispenser DUO „SUNDAY“

juice dispenser  
dispensador de zumo doble  
distributeur à jus de fruit double



**matt poliert, Kühlung durch 4 Kühlakkus von oben und unten**

satin polished finish, cooling with 4 cooling elements from the top and base

inox acabado pulido mate, 4 enfriadores en la base y en la tapa

inox mat, 4 accus. de froid (socle et couvercle)

	cm	↑ cm	ltr.
10862	35 x 45	48	2 x 6



### Saft- / Milchdispenser DUO „SUNDAY“

juice and milk dispenser  
dispensador mixto zumo y leche  
distributeur mixte à lait et à jus de fruit



**matt poliert, 1 Behälter gefrostet, 1 Behälter transparent, 4 Kühlakkus von oben und unten**

satin polished finish, 1 canister frosted look, 1 canister transparent, cooling with 4 cooling elements from the top and base

inox mate, 1 recipiente opaco, 1 recipiente transparente, 4 enfriadores (base y tapa)

inox mat, 1 récipient opaque, 1 récipient transparent, 4 accus. de froid (socle et couvercle)

	cm	↑ cm	ltr.
10864	35 x 45	48	2 x 6

**Saftbehälter transparent, ohne Zapfhahn / juice canister transparent, without tap / contenedor transparente sin grifo / récipient cylindrique sans le robinet**

	Ø cm	↑ cm	ltr.
10806	22	26	6

**Milchbehälter, gefrostet, ohne Zapfhahn / milk canister, frosted look, without tap / contenedor de leche, efecto glaseado, sin grifo / récipient cylindrique mat (idéal pour le lait) sans le robinet**

	Ø cm	↑ cm	ltr.
10805	22	26	6

**Hahn / tap / grifo / robinet**

10867



### Milchkanne „TOP FRESH“

milk dispenser  
dispensador de leche  
distributeur à lait



hochglanzpoliert, 1 Kühlakku im Standfuß, „original Milchkanne mit Henkel“  
mirror polished finish, 1 cooler in base, original milkcan  
inox brillante, 1 acumulador de frío en la base, recipiente „lechera“  
inox poli brillant, 1 accum. de froid dans le socle, design „pot à lait“

	cm	↑ cm	ltr.
10830	21 x 32	39	3
10750	23 x 35	45	5

Milchkanne ohne Zapfhahn / milkcan without tapjarra de leche sin grifo / récipient à lait sans robinet

	Ø cm	↑ cm	ltr.
10833	16	22	3
10663	22	26	5



4 ltr. / 6 ltr.

### Saftdispenser „BRIDGE“

juice dispenser  
dispensador de zumo  
distributeur à jus



Kühlung durch 2 Kühlakkus von oben und unten  
cooling with 2 cooling elements from the top and base  
2 acum. de frío 1 en la base y 1 en la tapa  
2 plaques de froid 1 dans le couvercle, 1 dans le socle

	cm	↑ cm	ltr.	Farbe / Colour
10870	31,0 x 20	42	4	Orange
10871	35,5 x 22	50	6	Orange



inkl. 3 Magnetschilder: ORANGE, APPLE, GRAPEFRUIT  
including 3 magnetic signs: ORANGE, APPLE, GRAPEFRUIT



4 ltr. / 6 ltr.

### Saftdispenser „BRIDGE“

juice dispenser  
dispensador de zumo  
distributeur à jus



Kühlung durch 2 Kühlakkus von oben und unten  
cooling with 2 cooling elements from the top and base  
2 acum. de frío 1 en la base y 1 en la tapa  
2 plaques de froid 1 dans le couvercle, 1 dans le socle

	cm	↑ cm	ltr.	Farbe / Colour
10872	31,0 x 20	42	4	Black
10873	35,5 x 22	50	6	Black



inkl. 3 Magnetschilder: ORANGE, APPLE, GRAPEFRUIT  
including 3 magnetic signs: ORANGE, APPLE, GRAPEFRUIT

## Buffet & Display



### Milchkanne „TOP FRESH“

milk dispenser  
dispensador de leche  
distributeur à lait



inkl. Porzellanschild zum Beschriften, 1 Kühllakku im Fuß  
incl. porcelain sign, 1 cooler in base  
incluye cartelito en porcelana, 1 enfriador en la base  
indicateur en porcelaine inclus, plaque de froid dans le socle

	cm	↑ cm	ltr.
10850	31 x 21	42	4



### Milchkanne „TOP FRESH“

milk dispenser  
dispensador de leche  
distributeur à lait



Buchen-Holz versiegelt, inkl. Porzellanschild zum Beschriften, 1 Kühllakku im Fuß  
beech wood, waterproof, incl. porcelain sign, 1 cooler in base  
madera de haya, resistente al agua, incluye placa de porcelana, 1 enfriador en la base  
socle bois hêtre traité, indicateur en porcelaine inclus, plaque de froid dans le socle

	cm	↑ cm	ltr.
10840	23 x 32,0	42	4
10757	27 x 38,5	45	8

Milchkanne Porzellan, ohne Zapfhahn / milkcan porcelain, without tap / jarra de leche sin grifo / récipient en porcelaine sans robinet

	Ø cm	↑ cm	ltr.
10825	18	25	4
10758	22	26	8

Deckel für 10840, 10850 / cover for 10840, 10850 / tapa para 10840, 10850 / couvercle pour 10840, 10850

10859

Deckel für 10757 / cover for 10757 / tapa para 10757 / couvercle pour 10757

10759

Schild und Kette / shield and chain / placa y cadena / indicateur porcelaine avec chaînette

10756

Zapfhahn / tap / grifo / robinet

10907



### Milchkanne WOOD „TOP FRESH“

milk dispenser  
dispensador de leche  
distributeur à lait



Buchen-Holz versiegelt, 1 Kühllakku im Standfuß, „original Milchkanne mit Henkel“  
beech wood, 1 cooler in base, original milkcan  
madera de haya, 1 acumulador de frio en base  
bois de hêtre, 1 plaque de froid dans le socle

	cm	↑ cm	ltr.
10835	21 x 32	39	3
10755	23 x 35	47	5



**Saftdispenser „INOX STAR“**

juice dispenser  
dispensador de zumo  
distributeur à jus de fruit



**Edelstahl-Crasheisröhre herausnehmbar**

stainless steel crash ice tube  
con tubo inox refrigerante extraíble para hielo picado  
avec tube inox réfrigérant amovible pour glace pilée

	cm	↑ cm	ltr.
10795	36 x 26	55	8



**Saftdispenser DUO „INOX STAR“**

juice dispenser  
dispensador de zumo  
distributeur à jus de fruit



**Edelstahl-Crasheisröhre herausnehmbar**

stainless steel crash ice tube  
con tubo inox refrigerante extraíble para hielo picado  
avec tubes inox réfrigérants amovibles pour glace pilée

	cm	↑ cm	ltr.
10810	36 x 52	55	2 x 8

**Behälter / container / recipiente / récipient**

	Ø cm	ltr.
10796	22	8

**Deckel 18/10 Edelstahl hochglanzpoliert / cover 18/10 stainless steel mirror polished finish / tapa 18/10 inox pulido brillante / couvercle inox 18/10 poli brillant**

10797

**Crasheisröhre / crash ice tube / tubo para hielo picado / tube pour glace pilée**

10798

**Non-Drip Hahn / non-drip-tap / grifo anti-goteo / robinet anti-goutte**

10799

**Dichtungsring / sealing ring / arandela / rondelle**

10793

**Silikondichtung / sealing / junta / joint**

10794

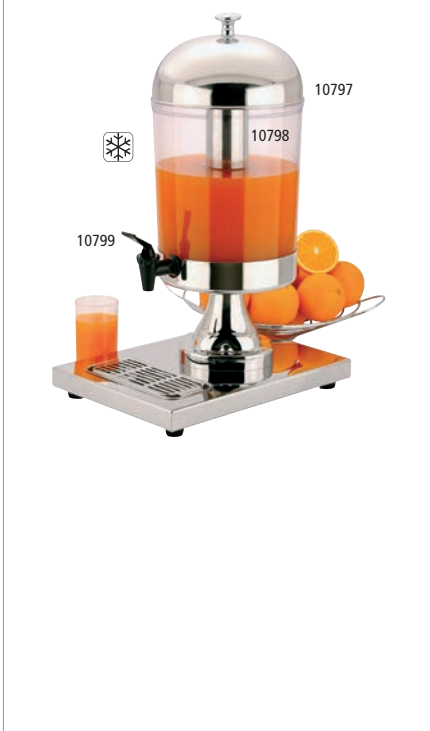

## Buffet & Display



### Pump-Isolierkanne „BUDGET“

air pot  
jarra termo  
bouteille isotherme



doppelwandig, Tragegriff, Dreh-Pumpknopf zur leichten Bedienung (close/open), Pumpmechanismus ist leicht zu entnehmen und zu reinigen, aufgeklappt passt die Kanne unter die gängigen Kaffeeautomaten, für heiße und kalte Getränke

double-walled, carrying handle, rotatable Push-Button for easy use (close/open), pump mechanism is easily removable for cleaning, with flipped-back lid, the air pot fits under a wide range of coffee makers, for hot and cold beverages

doble pared, con asa al lateral, tapa girable y a presión para uso fácil (close/open), el mecanismo a presión es fácil de retirar para limpiar, con la tapa abierta la jarra se puede usar con casi todas las cafeteras corrientes, para bebidas frías y calientes

double paroi, avec poignée, couvercle à visser et a pression pour facile usage (close/open), le mécanisme a pression est facile à retirer pour le nettoyage, avec la couvercle ouverte la bouteille se peut user avec toutes les machines à café courantes, pour boissons chaudes ou froides

	Ø cm	↑ cm	ltr.	Anzahl der Tassen
10915	13,5	32,5	2,2	17



### Pump-Isolierkanne „PREMIUM“

air pot  
jarra termo  
bouteille isotherme



doppelwandig, Tragegriff, drehbarer Fuß, Pumpmechanismus und Füllstandsanzeige sind leicht zu reinigen mit 4 unterschiedlichen Inhaltsbeschriftungen für den Pumphebel (coffee, tea, hot water, decaf), aufgeklappt passt die Kanne unter die gängigen Kaffeeautomaten, für heiße und kalte Getränke

double-walled, carrying handle, pivotable feet, pump mechanism and fill level indicator is easily removable for cleaning, includes 4 different beverage signs (coffee, tea, hot water, decaf), with flipped-back lid, the air pot fits under a wide range of coffee makers, for hot and cold beverages

doble pared, con asa al lateral, pié girable, el mecanismo a presión y el indicador óptico del nivel son fácil de limpiar, con 4 etiquetas diferentes para la palanca (coffee, tea, hot water, decaf), con la tapa abierta la jarra se puede usar con casi todas las cafeteras corrientes, para bebidas frías y calientes

double paroi, avec poignée, pied pivotant, le mécanisme a pression et l'indicateur de niveau sont facile à retirer pour le nettoyage, avec 4 étiquettes différents pour la pompe (coffee, tea, hot water, decaf), avec la couvercle ouverte la bouteille se peut user avec toutes les machines à café courantes, pour boissons chaudes ou froides

	Ø cm	↑ cm	ltr.	Anzahl der Tassen
10916	15	37	3	24

Tropfenfänger für Pump-Isolierkanne / drip tray for air pot / recoge gotas para jarra termo / ramasse-gouttes pour bouteilles isotherme

	cm	↑ cm
10917	24 x 18,5	4



### Isolierkanne „ECONOMY“

vacuum jug  
jarra termo  
bouteille isotherme



robuste Umhüllung mit Polypropylen-Kunststoff, Stabilglaseinsatz, Drehverschluss mit Drucktasten-Bedienung für heiße und kalte Getränke, 8 Tassen

double-walled with glass liner, screw cap with easy push-button pouring system, for hot and cold beverages, 8 cups

exterior de plástico polipropileno, interior aislante de vidrio, con tapa a rosca con cierre dosificador para bebidas frías y calientes, 8 tazas

extérieur en plastique polypropylène, intérieur avec plaque de verre, couvercle à visser, pour boissons chaudes ou froides, 8 tasses

	Ø cm	↑ cm	ltr.	Farbe / Colour
10913	16	20	1	White
10914	16	20	1	Black



**Isolierkanne „CLASSIC“**

vacuum jug  
jarra termo  
bouteille isotherme



doppelwandig, Einhandautomatik, Drehverschluss, für heiße und kalte Getränke  
double-walled, easy push-button pouring system, screw cap, for hot and cold drinks  
doble pared, se maneja con 1 mano, con tapa a rosca, para bebidas frías y calientes  
double paroi, usage à 1 main, couvercle à visser, pour boissons chaudes ou froides

	Ø cm	↑ cm	ltr.	Anzahl der Tassen
10910	14	19	1,0	8
10911	14	22	1,5	12
10912	14	25	2,0	16



**Isolierkanne „ADVANCED“**

vacuum jug  
jarra termo  
bouteille isotherme

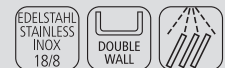

doppelwandig, spülmaschinenfest, Einhandautomatik, aufgeklappt passt die Kanne unter die gängigen Kaffeeautomaten, für heiße und kalte Getränke  
double-walled, dishwasher-safe, easy pouring system, with flipped-back lid, the air pot fits under a wide range of coffee makers, for hot and cold beverages  
doble pared, resistente al lavavajillas, se maneja con 1 mano, con la tapa abierta la jarra se puede usar con casi todas las cafeteras corrientes, para bebidas frías y calientes  
double paroi, résistante au lave-vaisselle, usage à 1 main, avec la couvercle ouverte a bouteille se peut user avec toutes les machines à café courantes, pour boissons chaudes ou froides

	Ø cm	↑ cm	ltr.	Anzahl der Tassen
10921	10,5	13,0	0,3	2,5
10922	10,5	18,0	0,6	5,0
10923	13,0	19,5	1,0	8,0
10924	13,0	23,5	1,5	12,0

**NEW ACACIA**

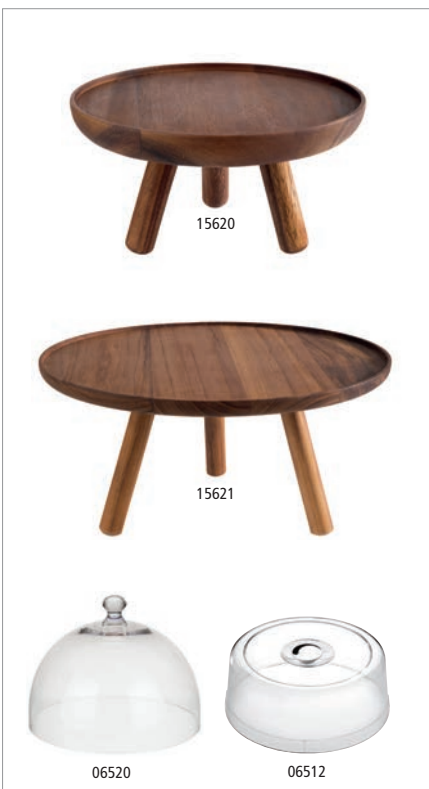

**Buffetständer „ACACIA“**

buffet stand  
soporte para buffet  
présentoir buffet



Akazienholz geölt / acacia wood oiled / mader de acacia aceitada / bois d'acacia huilé

	Ø cm	↑ cm
15620	20,0	10,5
15621	30,5	15,0
15622	30,5	20,0

**Frischhalte- Haube / cover / campana / cloche**



	Ø cm	↑ cm	fits to
06520	30	22	15621, 15622

**Frischhalte- Haube / cover / campana / cloche**



	Ø cm	↑ cm	fits to
06512	30	11,5	15621, 15622



**Buffetständer „ACACIA“**

buffet stand  
soporte para buffet  
présentoir buffet



Akazienholz geölt / acacia wood oiled / mader de acacia aceitada / bois d'acacia huilé

	cm	↑ cm	GN
15623	53 x 16,2	20	2/4

**GN Abdeckhaube / GN cover / GN cubierta/ GN cloche**



	cm	↑ cm	✱ mm	GN
11044	53 x 16,2	10,5	3	2/4



# Buffetständer



## Buffetständer „STAR“

buffet stand  
soporte para buffet  
présentoire buffet



**Metall, mit schwarzer Antirutschbeschichtung**  
metal, with black anti-slide coating  
metal, con revestimiento antideslizante negro  
métal, avec revêtement antidérapant noir

	↑ cm
33260	8
33261	12
33262	18



## Buffetständer „MULTI ROUND“

buffet stand  
soporte para buffet  
présentoir buffet



**Metall, mit schwarzer Antirutschbeschichtung**  
metal, with black anti-slide coating  
metal, con revestimiento antideslizante negro  
métal, avec revêtement antidérapant noir

	Ø cm	↑ cm
33269	15,5 / 18	8
33270	15,5 / 18	10
33271	15,5 / 18	18

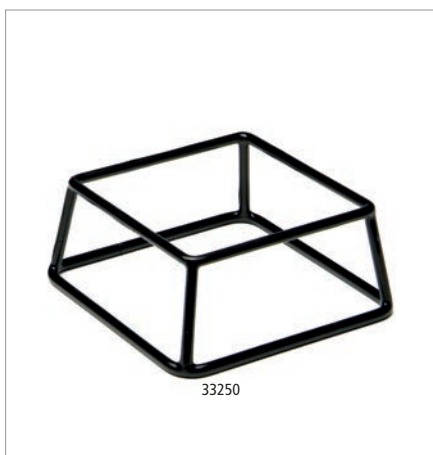

## Buffetständer „MULTI“

buffet stand  
soporte para buffet  
présentoir buffet



**Metall, mit schwarzer Antirutschbeschichtung**  
metal, with black anti-slide coating  
metal, con revestimiento antideslizante negro  
métal, avec revêtement antidérapant noir

	cm	↑ cm
33249	18 x 18	5
33250	18 x 18	8
33251	18 x 18	10
33252	18 x 18	18

## Buffet & Display

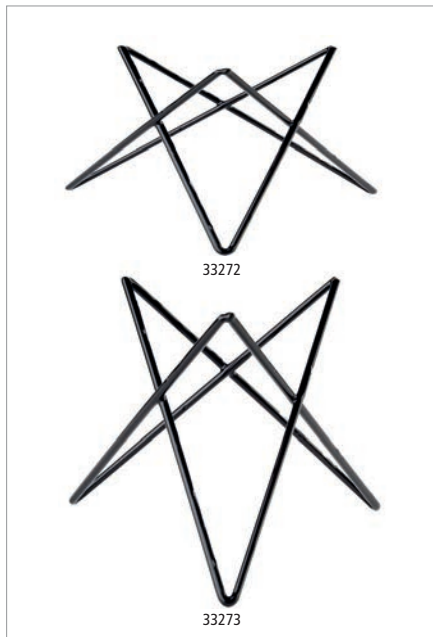

### Buffetständer „PRISMA“

buffet stand  
soporte para buffet  
présentoir buffet



**Metall, mit schwarzer Antirutschbeschichtung**

metal, with black anti-slide coating  
metal, con revestimiento antideslizante negro  
métal, avec revêtement antidérapant noir

	Ø cm	↑ cm
33272	20	10,5
33273	20	20,0



### Buffetständer „WOOD“

buffet stand  
soporte para buffet  
présentoir buffet



**Akazienholz, liegend oder stehend, variable Nutzungsmöglichkeiten**

acacia wood, usable by lying or standing, there are many possibilities to use  
madera de acacia, se puede usar tumbado o de pie, hay diferentes opciones de utilizar  
bois d'accacia, il y a différentes possibilités d'usage

	cm	↑ cm	Farbe / Colour
33280	20 x 20	17,5	
33281	20 x 20	17,5	



liegend oder stehend, variable Nutzungsmöglichkeiten  
vertically or horizontally, there are variable usage possibilities



### Buffetständer

buffet stand  
expositor de buffet  
présentoir buffet



**Akazienholz**

acacia wood  
madera de acacia  
bois d'accacia

	Ø cm	↑ cm
33255	15	10
33256	25	15

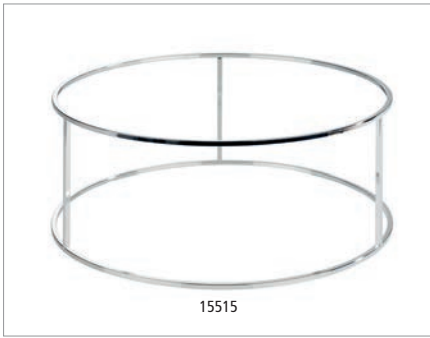

**Buffetständer „ASIA PLUS“**

buffet stand  
soporte para buffet  
présentoir buffet



	Ø cm	↑ cm	Farbe / Colour
15515	38,0	16,5	■
15516	38,0	27,0	■
15517	48,5	16,5	■
15518	48,5	27,0	■

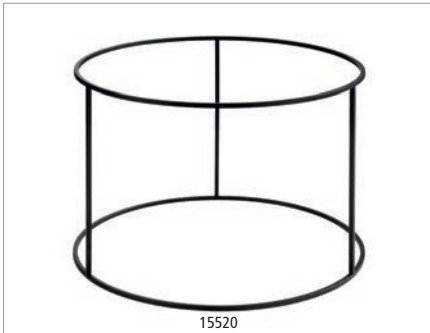

**Buffetständer „ASIA PLUS“**

buffet stand  
soporte para buffet  
présentoir buffet



	Ø cm	↑ cm	Farbe / Colour
15519	38,0	16,5	■
15520	38,0	27,0	■
15521	48,5	16,5	■
15522	48,5	27,0	■



**Buffetständer „ASIA PLUS“**

buffet stand  
soporte para buffet  
présentoir buffet



	Ø cm	↑ cm	Farbe / Colour
15513	20,5 / 16,5	20	■
15514	20,5 / 16,5	20	■



**Buffetständer „KING“**

buffet stand  
soporte para buffet  
présentoir buffet



kein Verrutschen, Arme und Boden sind mit Antirutschflächen ausgestattet, schwere standsichere Qualität, Fuß dient als Löffelablage

the arms and base are equipped with non-slip surfaces, stable quality, base serves as spoon holder  
anti-deslizante: revestimiento antideslizante en las puntas de los brazos y en la base, estable y alta calidad, la base sirve como reposacuchara

antiglisse: revêtement antidérapant sur les extrémités des 3 pieds et sur la base, robuste, stable et bonne qualité, la base sert de support pour les couverts

	Ø cm	↑ cm
03622	15	14
03623	15	21



**Buffet-Tower**

buffet tower  
torre para buffet  
tour carrée pour le buffet



3-stufig, Glas in Spiegeloptik, Holz Birke dunkelbraun, Lieferung demontiert  
with beech wood pillar, tempered glass mirror surface, each in knock-down packing  
3 pisos, vidrio templado, eje central de madera oscura, se entrega desmontado  
3 étages, verre trempé, axe central carré en bois foncé, livré non-monté

	cm	↑ cm
12415	25 x 25	30,5



## High Tea Rack

High Tea Rack  
rack de te alto  
étagère à thé avec anse supérieure



Holz dunkelbraun, Edelstahlgriff, 4 große Fächer 15 x 10 x 10 cm, 3 kleine Fächer 9,5 x 9,5 x 10 cm

rubber wood in dark brown, stainless handle, 4 big compartments 15 x 10 x 10 cm, 3 small compartments 9,5 x 9,5 x 10 cm

madera marrón oscura, mango de acero inoxidable, 4 compartimentos grandes 15 x 10 x 10 cm, 3 compartimentos pequeños 9,5 x 9,5 x 10 cm

bois marron foncé, poignée inox, 4 compartiment grand 15 x 10 x 10 cm, 3 compartiment petit 9,5 x 9,5 x 10 cm

	cm	↑ cm
33210	34 x 10	38

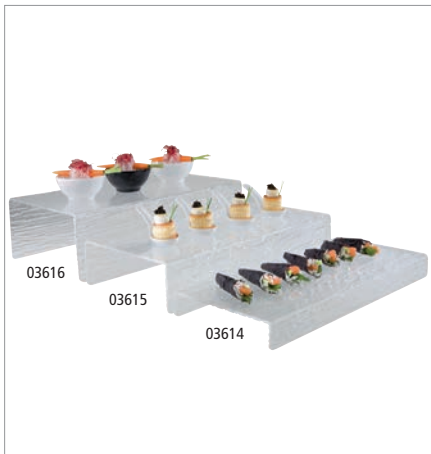

## Stufen-Display

tier display  
expositor en escalera  
présentoir en escalier



mit Schieferstruktur

with slate structure  
con relieve tipo pizarra  
avec relief irrégulier type ardoise

	cm	↑ cm
03614	40 x 18	4
03615	40 x 20	8
03616	40 x 22	12



## Stufen-Display, 3-tlg.

tier display, 3 pcs.  
expositor en escalera, set de 3  
présentoir en escalier, set de 3



3-teiliges Set: 03614 + 03615 + 03616

3 pcs. set: 03614 + 03615 + 03616

set de 3: 03614 + 03615 + 03616

set de 3: 03614 + 03615 + 03616

	cm	↑ cm
03617	40 x 18 / 40 x 20 / 40 x 22	4 / 8 / 12



## Stufen-Display, 3-tlg.

tier display, 3 pcs.  
expositor en escalera, set de 3  
présentoir en escalier, set de 3



3-teiliges Set: 03618 + 03619 + 03620

3 pcs. set: 03618 + 03619 + 03620

set de 3: 03618 + 03619 + 03620

set de 3: 03618 + 03619 + 03620

	cm	↑ cm
03621	20 x 18 / 20 x 20 / 20 x 22	4 / 8 / 12

NEW



passende Akazienholzplatte  
fitting acacia wood panels

33206



33207

Ø 25 cm, H: 1 cm



33207

Ø 25 cm, H: 1 cm



Gestell mit abgerundeten Füßen  
frame with rounded feet

### Buffetgestell „BIRDCAGE“

buffet stand  
soporte para buffet  
présentoir buffet

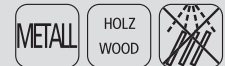

Gestell aus Metall schwarz, inkl. 2 Akazienholzplatten  
black metal frame, incl. 2 acacia wood panels  
soporte metálico negro, incl. 2 tableros de madera de acacia  
support métallique noir, avec 2 panneaux en bois d'acacia

	Ø cm	↑ cm	
33206	26	54	2-stufig / 2-tier / 2 alturas / 2 niveaux

Ersatz-Holzplatte / spare wooden panel / tablero de madera de recambio / panneau en bois de rechange rechange

	Ø cm	↑ cm	
33207	25	1	



Ø 12,0 cm

Ø 20,5 cm

Ø 25,0 cm

Ø 30,5 cm

### Buffetgestell „LIGHT HOUSE“

buffet stand  
soporte para buffet  
présentoir buffet



Gestell aus Metall schwarz, inkl. 4 Glasplatten  
frame made of metal, incl. 4 glass plates  
soporte metálico, incl. 4 placas de vidrio  
support métallique, avec 4 plaques de verre

	Ø cm	↑ cm	
11660	33	62	4-stufig / 4-tier / 4 alturas / 4 niveaux

Ersatz-Glasplatten / spare glass / fuente de recambio vidrio / plat de rechange en verre

	Ø cm		
11653	12 / 20,5 / 25,0 / 30,5	bestehend aus 4 Glasplatten	4er Set / 4 pcs. set / set de 4 / set de 4

## Buffet & Display

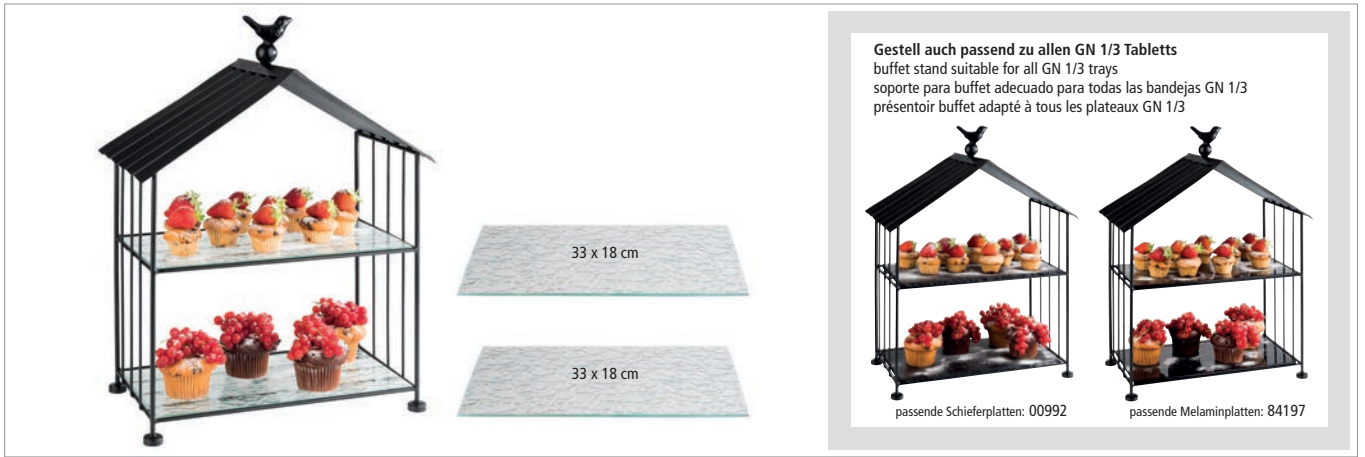

### Buffetgestell „BIRD“

buffet stand  
soporte para buffet  
présentoir buffet



Gestell aus Metall schwarz, inkl. 2 Glasplatten je 33 x 18 cm  
frame made of metal, incl. 2 glass plates, each 33 x 18 cm  
soporte metálico, incl. 2 placas de vidrio, cada una 33 x 18 cm  
support métallique, avec 2 plaques de verre, chacun 33 x 18 cm

	cm	↑ cm	fits to GN	
11661	37,5 x 21	50	1/3-trays	2-stufig / 2-tier / 2 alturas / 2 niveaux

Ersatz-Glasplatten / spare glass / fuente de recambio vidrio / plat de rechange en verre

	cm			
11654	33 x 18		bestehend aus 2 Glasplatten	2er Set / 2 pcs. set / set de 2 / set de 2



### Buffetgestell „TRIANGLE“

buffet stand  
expositor de buffet  
présentoir buffet



	cm	↑ cm	
13966	53 x 21	50	Ahorn / maple



### Buffetgestell „TRIANGLE“

buffet stand  
expositor de buffet  
présentoir buffet



	cm	↑ cm	
14966	53 x 21	50	Wenge / wenge

**NEW** Buffetbrücke



Präsentationsmöglichkeit / presentation opportunity



**Buffetbrücke**  
buffet bridge  
puente de buffet  
pont de buffet



**Buffetbrücke aus Akazienholz**  
buffet bridge from acacia wood  
puente de buffet de madera de acacia  
pont de buffet en bois d'acacia

	cm	↑ cm
33285	45 x 17	22
33286	70 x 17	22



Lieferung erfolgt demontiert  
delivery disassembled  
se entrega desmontada  
livraison démontée



**Buffettisch MINI „VINTAGE“**  
buffet stand  
soporte para buffet  
présentoir buffet



	cm	↑ cm	fits to
11634	40 x 21,5	15	GN 1/3 trays



**Buffetgestell**  
buffet stand  
soporte para buffet  
présentoir buffet



3-stufig, geeignet für runde und rechteckige Körbe, platzsparend zusammenklappbar  
3-tier, usable for round and rectangular baskets, can be pushed together for place saving  
3 alturas, apto para cestas redondas y rectangulares, se puede plegar para ahorrar espacio  
3 hauteurs, pour corbeilles rondes ou rectang, la structure s'ouvre ou se ferme pour réduire l'encombrement

	cm	↑ cm
33232	59 x 30,5	59

Tisch- und Buffetkorb, rund „ECONOMIC“ / buffet basket, round / cesta de bufé redonda / corbeille de buffet ronde

	Ø cm	↑ cm	Farbe / Colour
40144	39	10	<span style="background-color: #FFD700; width: 20px; height: 10px; display: inline-block;"></span>

Lieferung ohne Körbe  
delivery without baskets

# BUFFETDISPLAY



**Buffetgestell, 3-tlg.**  
buffet stand, 3 pcs.  
expositor de buffet, set de 3  
présentoir buffet, set de 3



3-teilig:

1. Fach 40 x 23 cm x H 33 cm;
2. Fach 40 x 20,5 cm x H 20 cm;
3. Fach 40 x 18 cm x H 9 cm

3 pcs. set: 40 x 23 cm x H 33 cm; 40 x 20,5 cm x H 20 cm; 40 x 18 cm x H 9 cm  
set de 3: 40 x 23 cm x H 33 cm; 40 x 20,5 cm x H 20 cm; 40 x 18 cm x H 9 cm  
set de 3: 40 x 23 cm x H 33 cm; 40 x 20,5 cm x H 20 cm; 40 x 18 cm x H 9 cm

	cm	↑ cm	Farbe / Colour	
11606	40 x 23	33		Wenge

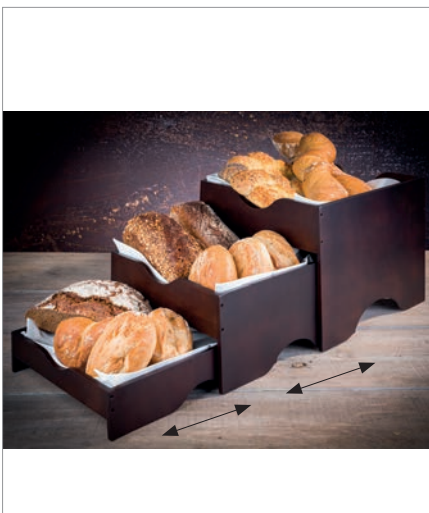

**Buffetgestell, 3-tlg.**  
buffet stand, 3 pcs.  
expositor de buffet, set de 3  
présentoir buffet, set de 3



3-teilig:

1. Fach 40 x 40 cm x H 33 cm;
2. Fach 40 x 37 cm x H 20 cm;
3. Fach 40 x 34 cm x H 9 cm

3 pcs. set: 40 x 40 cm x H 33 cm; 40 x 37 cm x H 20 cm; 40 x 34 cm x H 9 cm  
set de 3: 40 x 40 cm x H 33 cm; 40 x 37 cm x H 20 cm; 40 x 34 cm x H 9 cm  
set de 3: 40 x 40 cm x H 33 cm; 40 x 37 cm x H 20 cm; 40 x 34 cm x H 9 cm

	cm	↑ cm	Farbe / Colour	
11607	40 x 40	33		Wenge





**Etagère „ROYAL“**

etagère  
expositor  
présentoir



5-teilig: 3 Edelstahl-Schalen + 2 Gestelle, einfach übereinanderstellen, einzeln nutzbar

5 pcs. set: 3 bowls + 2 frames, easy to assemble, single usable

set de 5: 3 bols + 2 soportes, fácil de montar

set de 5: 3 bols + 2 supports, montage facile

	Ø cm	↑ cm
24336	24 / 33 / 42	43,5

Schale / bowl / fuente / plateau

	Ø cm	↑ cm	litr.
24330	24	3	0,6
24331	33	4	1,3
24332	42	5	2,5

Gestell einzeln / stand alone / pie soporte / pied seul

	Ø cm	↑ cm
24338	18	19
24339	24	20



**Etagère „ROYAL“**

etagère  
estante  
présentoir



3-teilig: 2 Edelstahl-Schalen + 1 Gestell, einfach übereinanderstellen, einzeln nutzbar

3 pcs. set: 2 bowls + 1 frame, easy to assemble, single usable

set de 3: 2 bols + 1 soporte, fácil de montar

set de 3: 2 bols + 1 support, montage facile

	Ø cm	↑ cm
24335	33 / 42	25
24334	24 / 33	22

Schale / bowl / fuente / plateau

	Ø cm	↑ cm	litr.
24330	24	3	0,6
24331	33	4	1,3
24332	42	5	2,5

Gestell einzeln / stand alone / pie soporte / pied seul

	Ø cm	↑ cm
24338	18	19
24339	24	20



**Etagère**

etagère  
frutero  
corbeille à fruits



ergonomischer Griff, stehend auf schwarzen Antirutsch-Füßen

ergonomic handle, anti-slip-feets

asa ergonómica, pies antideslizantes color negro

anse ergonomique, pieds antidérapants noirs

	cm	↑ cm
30325	30 x 30	35,5

**NEW** ROMANTIC

*Eyecatcher-  
Guarantee*



33204



33201





33203

**Serviergestell „ROMANTIC“**



serving stand  
soporte platos  
présentoir à assiettes

EDELSTAHL  
STAINLESS  
INOX

für 3 Teller max. Ø 17,5 cm, innerer Ring Ø 10 cm, Lieferung ohne Teller  
for 3 plates max. Ø 17,5 cm, circle inside Ø 10 cm, delivery without dishes  
para 3 platos máx. Ø 17,5 cm, aro interior Ø 10 cm, se entrega sin platos  
pour 3 assiettes Ø 17,5 cm maxi., anneau intérieur Ø 10 cm, livré sans assiettes

	cm	↑ cm	Farbe / Colour	
33200	22,5 x 16	32		weiß / white
33202	22,5 x 16	32		schwarz / black
33204	22,5 x 16	32		antik-kupfer / antique-copper

für 3 Teller max. Ø 27 cm, innerer Ring Ø 16 cm, Lieferung ohne Teller  
for 3 plates max. Ø 27 cm, circle inside Ø 16 cm, delivery without dishes  
para 3 platos máx. Ø 27 cm, aro interior Ø 16 cm, se entrega sin platos  
pour 3 assiettes Ø 27 cm maxi., anneau intérieur Ø 16 cm, livré sans assiettes

	Ø cm	↑ cm	Farbe / Colour	
33201	30	54		weiß / white
33203	30	54		schwarz / black
33205	30	54		antik-kupfer / antique-copper



**Serviergestell**

serving stand  
soporte platos  
présentoir à assiettes



für 4 Teller (max. Ø 31 cm), platzsparend zusammenziehbar, Lieferung ohne Teller  
for 4 plates (max. Ø 31 cm), can be pushed together for place saving, without dishes  
para 4 platos (max. Ø 31 cm) se puede plegar para ahorrar espacio, se sirve sin platos  
pour 4 assiettes (maxi Ø 31 cm), peut se refermer pour réduire l'encombrement, livré sans assiettes

	Ø cm	↑ cm
33225	34	37



**Serviergestell**

serving stand  
soporte platos  
présentoir à assiettes



für 2 Teller max. Ø 27 cm, innerer Ring Ø 18 cm, Lieferung ohne Teller  
for 2 plates max. Ø 27 cm, circle inside Ø 18 cm, without dishes  
para 2 platos Ø 27 cm, interior aro Ø 18 cm, se entrega sin platos  
pour 2 assiettes maxi Ø 27 cm, cercle Ø int. 18 cm, livré sans assiettes

	cm	↑ cm
33214	33 x 23,5	30



**Serviergestell**

serving stand  
soporte platos  
présentoir à assiettes



für 3 Teller max. Ø 17 cm, innerer Ring Ø 10,5 cm  
for 3 plates max. Ø 17 cm, circle inside Ø 10,5 cm  
para 3 platos Ø 17 cm, interior aro Ø 10,5 cm  
pour 3 assiettes maxi Ø 17 cm, cercle Ø int. 10,5 cm

	cm	↑ cm
33216	22,5 x 16,5	25,5



**Serviergestell**

serving stand  
soporte platos  
présentoir à assiettes



für 3 Teller max. Ø 27 cm, innerer Ring Ø 18 cm  
for 3 plates max. Ø 27 cm, circle inside Ø 18 cm  
para 3 platos Ø 27 cm, interior aro Ø 18 cm  
pour 3 assiettes maxi Ø 27 cm, cercle Ø int. 18 cm

	cm	↑ cm
33217	33 x 24	43

## Buffet & Display

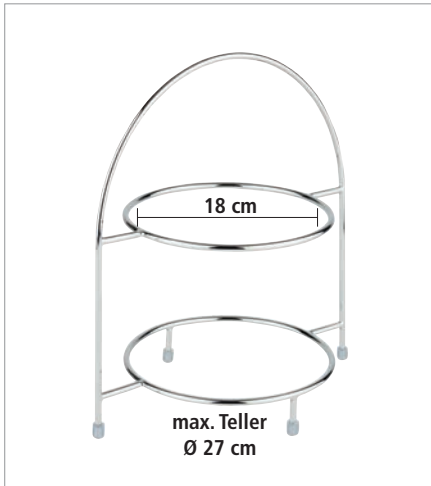

### Serviergestell

serving stand  
soporte platos  
présentoir à assiettes



für 2 Teller max. Ø 27 cm, innerer Ring Ø 18 cm  
for 2 plates max. Ø 27 cm, circle inside Ø 18 cm  
para 2 platos Ø 27 cm, interior aro Ø 18 cm  
pour 2 assiettes maxi Ø 27 cm, cercle Ø int. 18 cm

	cm	↑ cm	Farbe / Colour
33219	29 x 19,5	30	



### Serviergestell

serving stand  
soporte platos  
présentoir à assiettes



für 3 Teller max. Ø 17 cm, innerer Ring Ø 10,5 cm  
for 3 plates max. Ø 17 cm, circle inside Ø 10,5 cm  
para 3 platos Ø 17 cm, interior aro Ø 10,5 cm  
pour 3 assiettes maxi Ø 17 cm, cercle Ø int. 10,5 cm

	cm	↑ cm	Farbe / Colour
33215	18,5 x 15,5	26	chrome
33211	18,5 x 15,5	26	copper



### Serviergestell

serving stand  
soporte platos  
présentoir à assiettes



für 3 Teller max. Ø 27 cm, innerer Ring Ø 18 cm  
for 3 plates max. Ø 27 cm, circle inside Ø 18 cm  
para 3 platos Ø 27 cm, interior aro Ø 18 cm  
pour 3 assiettes maxi Ø 27 cm, cercle Ø int. 18 cm

	cm	↑ cm	Farbe / Colour
33220	29 x 19,5	43	chrome
33212	29 x 19,5	43	copper



### Etagère

etagère  
frutero  
présentoir à fruits



hochglanzpoliert, Edelstahl-Schale herausnehmbar  
mirror polished finish, bowl removable  
acabado brillante, bandeja inferior suelta  
effet brillant, bol inférieur amovible

	Ø cm	↑ cm
33235	27,5	32
33240	32,0	53



**Servier- und Tortenplatte „ACACIA MINI“**

cake stand  
porta pasteles  
présentoir à gâteaux

Akazienholz geölt  
acacia wood oiled  
madera de acacia aceitada  
bois d'acacia huilé



	Ø cm	↑ cm
33290	9,5	7
33291	13,0	9



**Servier- und Tortenplatte „ACACIA“**

cake stand  
porta pasteles  
présentoir à gâteaux

Akazienholz geölt  
acacia wood oiled  
madera de acacia aceitada  
bois d'acacia huilé



	Ø cm	↑ cm
33292	24,0	8
33293	24,0	16
33294	33,0	8
33295	33,0	16
33296	38,5	8
33297	38,5	16



**Frischhalte- Haube / cover / campana / cloche**



	Ø cm	↑ cm	fits to
06519	21	17	33292, 33293
06520	30	22	33294, 33295
06521	36	27	33296, 33297

## Buffet & Display



### Serviergestell

serving stand  
expositor  
présentoir



3-stufig für quadratische Teller / Platten in 3 verschiedenen Größen:  
z.B. 83407 + 83406 + 83405, Lieferung ohne Teller/Platten

3-tier for square dishes / plates in 3 different sizes: e.g. 83407 + 83406 + 83405,  
delivery without dishes / plates

3 alturas para platos cuadrados fuentes en 3 diferentes medidas p.e. 83407 + 83406 + 83405,  
se entrega sin platos/ fuentes

3 niveaux pour assiettes ou plats carrés de différentes dimensions, ex. 83407 + 83406 + 83405,  
livré sans assiettes

	cm	↑ cm
33231	37,5 x 37,5	50



### Etagère „CASUAL“

etagère  
expositor de bombones o bocaditos  
présentoir à mignardises



inklusive Edelstahl-Schild, beschriftbar

including sign

placa incluida, sin inscripción

étiquette incluse, sans inscription

	Ø cm	↑ cm	
34248	31 - 41 - 51	55	3-stufig / 3-tier 3 niveles / 3 étages
34247	31 - 41	35	2-stufig / 2-tier 2 niveles / 2 étages



### Etagère „FINESSE“

etagère  
frutero  
étagère



vergoldeter Messing-Kugelgriff, einfache Montage

gold plated knob, easy to assemble

botón dorado, fácil de montar

bouton doré, montage facile

	Ø cm	↑ cm	
33248	48 / 38 / 32	50	3-stufig / 3-tier 3 alturas / 3 niveaux
33238	38 / 32	30	2-stufig / 2-tier 2 alturas / 2 niveaux



### 3-stufige Etagère

3-tier tray  
bandeja con tres alturas  
étagère carré 3 hauteurs



Naturschiefer, Akazienholz

natural slate tray, wood akazie

bandeja de pizarra natural, madera de acacia

plateau ardoise naturelle, bois d'acacia

	Ø cm	↑ cm	mm
00960	30 / 25 / 20	34	6 - 9



**2-stufige Etagère**  
2 tier tray  
bandeja dos alturas  
plat carré 2 hauteurs

Naturschiefer  
natural slate tray  
bandeja de pizarra natural  
plateau ardoise naturelle



	Ø cm	↑ cm	* mm
00989	25 / 20	24	6 - 9



**Brezel- oder Wurstständer**  
pretzel-/ sausage stand  
soporte para embutidos  
support à bretzel ou à saucissons

Verkaufsständer Buchen-Holz versiegelt, bestens geeignet für die Präsentation von Brezeln, Würstchen, etc., Fuß Ø 22 cm  
beech wood, ideal to present pretzels, sausages, etc.  
madera de haya, ideal para presentar fiambres, salchichones etc.  
en hêtre, idéal pour bretzels ou saucissons, etc.



	Ø cm	↑ cm
79553	28	50

**Hygieneschutz für Brezelständer / hygienic cover / cubierta higiénica antialiento / pare-haleine**

	cm	↑ cm
11557	20 x 20 x 20	50
11558	15 x 20 x 15	50



**Serviergestell, 2-stufig**  
serving stand, 2-tier  
soporte platos, 2 alturas  
présentoir, 2 hauteurs

3 tlg. Set, 1 Gestell aus Akazienholz, 2 Schieferplatten, zusammenklappbar  
3 pcs. set, 1 stand acacia wood, 2 slate tray, foldable  
set de 3: 1 soporte madera de acacia, 2 bandeja de pizarra, fácil de plegar  
set de 3: 1 présentoir au pour tous les seaux à FRAMES



**zusammenklappbar**  
foldable

	cm	↑ cm
00958	36,5	34 x 26,5



**Serviergestell „FLEXIBEL“**  
serving stand  
expositor  
présentoir

3-stufig „beweglich / drehbar“, platzsparend zerlegbar  
3 tier, flexible frame, space saving  
3 alturas, marco flexible, ahorra espacio  
3 hauteurs, cadre souple, gagne de la place



	cm	↑ cm
33243	45,5 x 32	21,5

**Tablett „PURE COLOR“ / tray / bandeja / plateau**

	cm	↑ cm	Farbe / Colour
83403	35,5 x 18	3	_____



### Serviergestell „S-PURE“

serving stand  
soporte buffet  
support buffet



für 3 Tablett quadratisch 83407 oder 83418

for 3 trays square 83407 or 83418

para 3 bandejas cuadradas 83407 o 83418

pour 3 plats carrés 83407 ou 83418

	cm	↑ cm
33226	29 x 17	41



### Serviergestell „M-PURE“

serving stand  
soporte buffet  
support buffet



für 3 Tablett quadratisch 83406 oder 83407

for 3 trays square 83406 or 83407

para 3 bandejas cuadradas 83406 o 83407

pour 3 plats carrés 83406 o 83407

	cm	↑ cm
33227	33 x 21	44



### Serviergestell „L-PURE“

serving stand  
soporte buffet  
support buffet



für 3 Tablett rechteckig 83417

for 3 trays rectangular 83417

para 3 bandejas rectangulares 83417

pour 3 plats rectangulaires 83417

	cm	↑ cm
33228	37 x 21	44



### GN Serviergestell „XL-PURE“

GN serving stand  
GN soporte buffet  
GN support buffet



passend für Tablett GN 1/1, GN 1/2, GN 1/3, GN 2/4

suitable for tray GN 1/1, GN 1/2, GN 1/3, GN 2/4

aptas para bandejas GN 1/1, GN 1/2, GN 1/3, GN 2/4

convient pour les plats GN 1/1, GN 1/2, GN 1/3, GN 2/4

	cm	↑ cm
33222	63 x 27	44,5





**Buffetgestell „FLOAT SMALL“**

buffet stand  
soporte buffet  
support buffet



Metall verchromt, für 3 Schalen Nr. 83916, 83917  
metal chrome plated, for 3 bowls no. 83916, 83917  
metal cromado, para 3 cuencos N° 83916, 83917  
métal chromé, pour 3 coupelles 83916, 83917

	cm	↑ cm
33241	55,5 x 19	15,5

**Schale „FLOAT“ / bowl / cuenco / bol**

	cm	↑ cm	Farbe / Colour
83916	19 x 19	9,5	White
83917	19 x 19	9,5	Black



**Buffetgestell „FLOAT BIG“**

buffet stand  
soporte buffet  
support buffet



Metall verchromt, für 3 Schalen Nr. 83914, 83915, für 1 Schale Nr. 83918, 83919  
metal chrome plated, for 3 bowls no. 83914, 83915, for 1 bowl no. 83918, 83919  
metal cromado, para 3 cuencos N° 83914, 83915, para 1 cuenco N° 83918, 83919  
métal chromé, pour 3 coupelles 83914, 83915 ou 1 bol 83918, 83919

	cm	↑ cm
33242	39 x 39	17

**Schale „FLOAT“ / bowl / cuenco / bol**

	cm	↑ cm	Farbe / Colour
83914	12,5 x 12,5	6,0	White
83918	25,0 x 25,0	12,0	White
83915	12,5 x 12,5	6,0	Black
83919	25,0 x 25,0	12,0	Black

# Buffetleiter GN



## Buffetleiter „LITTLE GN 1/3“

buffet ladder  
dispensador en escalera  
présentoir buffet en escalier



4-teilig: 1 Leiter-Gestell, 3 GN 1/3 Rahmen  
4 pcs.: 1 ladder, 3 single rings GN 1/3  
4 pz: 1 soporte escalera, 3 aros sencillos GN 1/3  
4 pc: 1 support escalier, 3 cercles simples GN 1/3

	cm	↑ cm	fits to
11526	31,5 x 32	48	baskets / pans GN 1/3



## Buffetleiter „LITTLE GN 1/2“

buffet ladder  
dispensador en escalera  
présentoir buffet en escalier



4-teilig: 1 Leiter-Gestell, 3 GN 1/2 Rahmen  
4 pcs.: 1 ladder, 3 single rings GN 1/2  
4 pz: 1 soporte escalera, 3 aros sencillos GN 1/2  
4 pc: 1 support escalier, 3 cercles simples GN 1/2

	cm	↑ cm	fits to
11527	31,5 x 41,5	48	baskets / pans GN 1/2

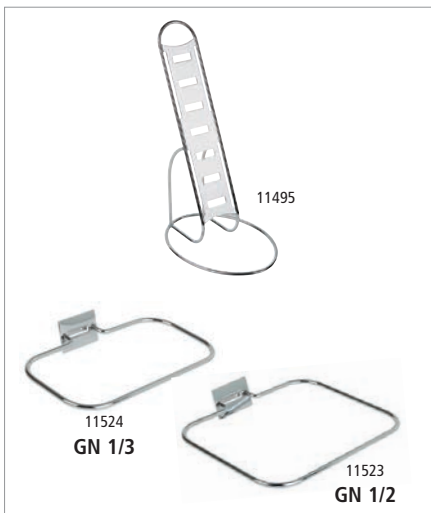

Einzelteile / spare parts / piezas sueltas / pièces détachées

Leitergestell / frame / marco solo en escalera / échelle support

11495

Einzelring GN 1/3 / single ring GN 1/3 / aro sencillo GN 1/3 / cercle simple GN 1/3

11524

Einzelring GN 1/2 / single ring GN 1/2 / aro sencillo GN 1/2 / cercle simple GN 1/2

11523



**Buffetleiter „BIG GN 1/2“**

buffet ladder  
dispensador en escalera  
présentoir buffet en escalier



5-teilig: 1 Leiter-Gestell, 4 GN 1/2 Rahmen  
5 pcs.: 1 ladder, 4 single rings GN 1/2  
5 pz: 1 soporte escalera, 4 aros sencillos GN 1/2  
5 pc: 1 support escalier, 4 cercles simples GN 1/2

	cm	↑ cm	fits to
11528	31,5 x 56	66	baskets / pans GN 1/2



**Buffetleiter „BIG GN 1/1“**

buffet ladder  
dispensador en escalera  
présentoir buffet en escalier



4-teilig: 1 Leiter-Gestell, 3 GN 1/1 Rahmen  
4 pcs.: 1 ladder, 3 single rings GN 1/1  
4 pz: 1 soporte escalera, 3 aros sencillos GN 1/1  
4 pc: 1 support escalier, 3 cercles simples GN 1/1

	cm	↑ cm	fits to
11529	52 x 59	66	baskets / pans GN 1/1

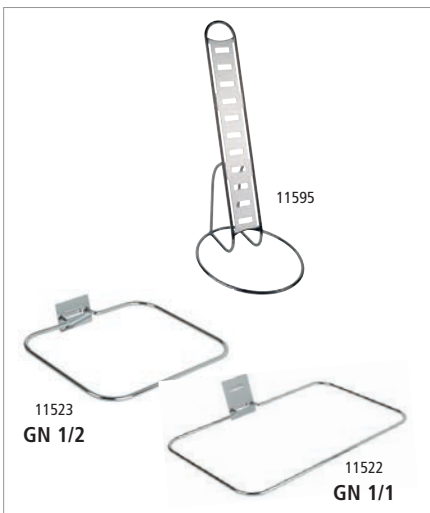

Einzelteile / spare parts / piezas sueltas / pièces détachées

Leitergestell / frame / marco solo en escalera / échelle support

11595

Einzelring GN 1/2 / single ring GN 1/2 / aro sencillo GN 1/2 / cercle simple GN 1/2

11523

Einzelring GN 1/1 / single ring GN 1/1 / aro sencillo GN 1/1 / cercle simple GN 1/1

11522

## Buffet & Display



### Buffetleiter „BIG“

buffet ladder  
dispensador en escalera  
présentoir buffet en escalier



12-teiliges Set: 4 Glasschalen Ø 23 cm 2,5 Liter, 4 klappbare Schutzdeckel mit Beschriftungsfenster, 1 Leiter, 1 Doppelring, 2 Einzelringe, einfach und individuell zusammensetzbar

12 pcs. set: 4 glass bowls Ø 23 cm 2.5 litres, 4 hinged covers with card for inscription, 1 ladder, 1 double ring, 2 single rings, easy to fix and individual to use

set de 12: 4 boles vidrio Ø 23 cm 2,5 l, 4 tapas abatibles con ventana para etiqueta, 1 soporte escalera, 1 aro doble, 2 aros sencillos, fácil de montar, posible usar individualmente

set de 12: 4 bols verre Ø 23 cm 2,5 l, 4 couvercles à charnière et fenêtre p/ étiquette, 1 support escalier, 1 cercle double, 2 cercles simples, montage facile, utilisable individuellement

	cm	↑ cm
11598	39 x 31	66



### Buffetleiter „BIG“

buffet ladder  
dispensador en escalera  
Présentoir buffet en escalier



11-teiliges Set: 6 Glasschalen Ø 23 cm 2,5 Liter, 1 Leiter, 2 Doppelringe, 2 Einzelringe, einfach und individuell zusammensetzbar

11 pcs. set: 6 glass bowls Ø 23 cm 2.5 litres, 1 ladder, 2 double rings, 2 single rings, easy and individual to use

set de 11: 6 boles vidrio Ø 23 cm 2,5 l, 1 soporte escalera, 2 aros dobles, 2 aros sencillos, fácil montar, se puede usar individualmente

set de 11: 6 bols verre Ø 23 cm 2,5 l, 1 support escalier, 2 cercles double, 2 cercles simples, montage facile, utilisable individuellement

	cm	↑ cm
11599	39 x 31	66

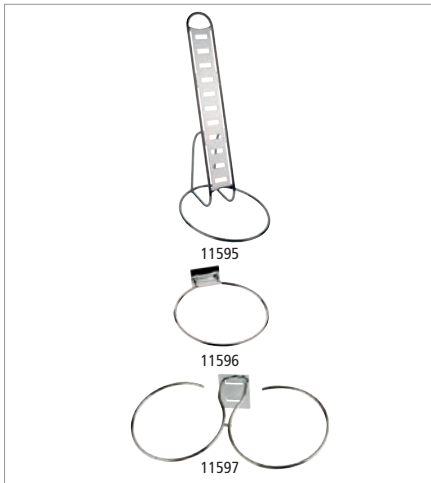

Einzelteile / spare parts / piezas sueltas / pièces détachées

Leitergestell / frame / marco solo en escalera / échelle support

11595

Einzelring / single ring / aro sencillo / cercle simple

11596

Doppelring / double ring / aro doble / cercle double

11597



### Schale

bowl  
cuenco  
bol



	Ø cm	↑ cm	ltr.
11875	23	10,5	2,5



### Schutzdeckel mit Löffelaussparung

cover  
tapa  
couvercle



	Ø cm
11878	23,5



**Buffetleiter „LITTLE“**

buffet ladder  
dispensador en escalera  
présentoir buffet en escalier



12-teiliges Set: 4 Glasschalen Ø 14 cm 0,5 Liter, 4 klappbare Schutzdeckel mit Beschriftungsfenster, 1 Leiter, 1 Doppelring, 2 Einzelringe, einfach und individuell zusammensetzbar

12 pcs. set: 4 glass bowls Ø 14 cm 0.5 litres, 4 hinged covers with card for inscription, 1 ladder, 1 double ring, 2 single rings, easy and individual to use

set de 12: 4 boles vidrio Ø 14 cm 0,5 l, 4 tapas abatibles con ventana para etiqueta, 1 soporte escalera, 1 aro doble, 2 aros sencillos, fácil montaje, se puede usar individualmente

set de 12: 4 bols verre Ø 14 cm 0,5 l, 4 couvercles à charnière et fenêtre p/ étiquette, 1 support escalier, 1 cercle double, 2 cercles simples, montage facile, utilisable individuellement

	cm	↑ cm
11498	30 x 30	48

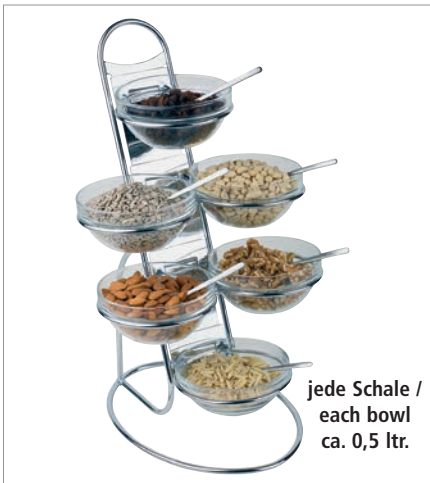

**Buffetleiter „LITTLE“**

buffet ladder  
dispensador en escalera  
Présentoir buffet en escalier



11-teiliges Set: 6 Glasschalen Ø 14 cm 0,5 Liter, 1 Leiter, 2 Doppelringe, 2 Einzelringe, einfach und individuell zusammensetzbar

11 pcs. set: 6 glass bowls Ø 14 cm 0.5 litres, 1 ladder, 2 double rings, 2 single rings, easy and individual to use

set de 11: 6 boles vidrio Ø 14 cm 0,5 l, 1 soporte escalera, 2 aros dobles, 2 aros sencillos, fácil montaje, se puede usar individualmente

set de 11: 6 bols verre Ø 14 cm 0,5 l, 1 support escalier, 1 cercle double, 2 cercles simples, montage facile, utilisable individuellement

	cm	↑ cm
11499	30 x 30	48

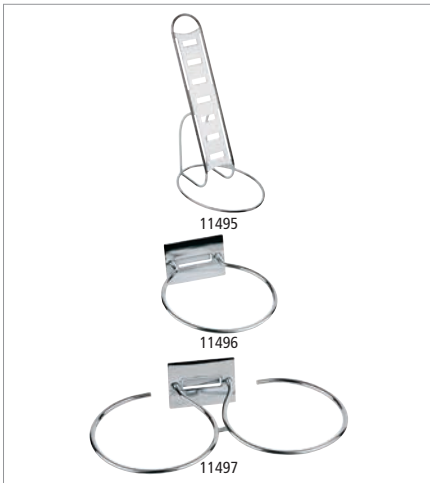

Einzelteile / spare parts / piezas sueltas / pièces détachées

Leitergestell / frame / marco solo en escalera / échelle support

11495

Einzelring / single ring / aro sencillo / cercle simple

11496

Doppelring / double ring / aro sencillo / cercle double

11497



**Schale**

bowl  
cuenco  
bol



	Ø cm	↑ cm	ltr.	pcs.
11865	14	6,5	0,5	6



**Schutzdeckel mit Löffelaussparung**

cover  
tapa  
couvercle



	Ø cm
11868	14,5

## Buffet & Display



### Buffetgestell „SUNDAY“

buffet stand  
expositor bufé  
présentoir buffet



7-teiliges Set: 3 Glasschalen Ø 23 cm (2,5 Liter), 3 klappbare Schutzdeckel, 1 Gestell

7 pcs. set: 3 glass bowls Ø 23 cm (2,5 litres), 3 hinged covers, 1 stand

set de 7: 3 boles vidrio Ø 23 cm (2,5 l), 3 tapas con bisagra, 1 soporte

set de 7: 3 bols verre Ø 23 cm (2,5 l), 3 couvercles à charnière, 1 support

	cm	↑ cm
11795	61 x 24	35



### Buffetständer „BIG“

buffet stand  
expositor de buffet  
présentoir buffet



7-teiliges Set: 3 Glasschalen Ø 23 cm 2,5 Liter, 3 klappbare Schutzdeckel, 1 Ständer

7 pcs. set: 3 glass bowls Ø 23 cm 2.5 litres, 3 hinged covers, 1 stand

set de 7: 3 boles vidrio Ø 23 cm, 2,5 l, 3 tapas con bisagra, 1 soporte

set de 7: 3 bols verre Ø 23 cm 2,5 l, 3 couvercles à charnière, 1 support

	cm	↑ cm
11892	50 x 50	18



### Buffetständer „LITTLE“

buffet stand  
expositor de buffet  
présentoir buffet



7-teiliges Set: 3 Glasschalen Ø 14 cm 0,5 Liter, 3 klappbare Schutzdeckel, 1 Ständer

7 pcs. set: 3 glass bowls Ø 14 cm 0,5 l, 3 hinged covers, 1 stand

set de 7: 3 boles vidrio Ø 14 cm, 0,5 l, 3 tapas con bisagra, 1 soporte

set de 7: 3 bols verre Ø 14 cm 0,5 l, 3 couvercles à charnière, 1 support

	cm	↑ cm
11893	30 x 30	14



### Besteckständer „TRIPLE TOWER“

cutlery basket  
cesta para cubiertos  
égouttoir à couverts



4-teiliges Set: 1 Gestell + 3 Köcher

4 pcs. set: 1 frame + 3 baskets

set de 4: 1 estructura + 3 cubiertos

set de 4: 1 structure + 3 corbeilles

	cm	↑ cm	Farbe / Colour
11466	18 x 26	43	White
11467	18 x 26	43	Black



variable Nutzungsmöglichkeiten  
variable usage possibilities



**Vitrine / Thekenaufsatz**

showcase  
vitrina de mostrador  
vitrine de comptoir



rutschfest, aus einem Teil gefertigt  
antislip, monoblock produced  
plástico transparente, fabricado en 1 pieza  
transparente, plastique monoblock (injecté)

	cm	↑ cm
11888	63,5 x 25	25



**Snackpresenter**

snackpresenter  
dispensador de bocadillos  
présentoir à sandwiches



mit Safrille und Griffmulde, passend für Vitrine 11888  
with recessed grip, suitable for showcase 11888  
asa moldeada, apto para la vitrina 11888  
anse moulée, apte pour vitrine 11888

	cm	↑ cm	
11887	29 x 19	6,5	3 Mulden / 3 compartments 3 compartimentos / 3 compartments
11889	60 x 19	7,5	6 Mulden / 6 compartments 6 compartimentos / 6 compartments

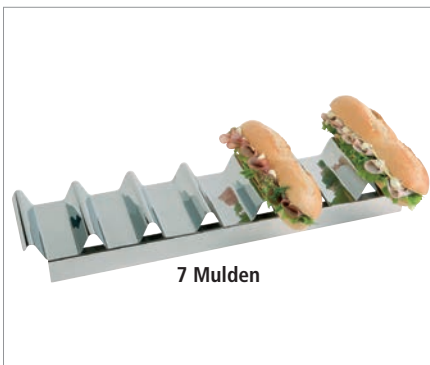

**Snackpresenter**

snackpresenter  
dispensador de bocadillos  
présentoir à sandwiches



hochglanzpoliert, mit Griffmulde, für 7 Baguettes  
mirror polished finish, with recessed grip, for 7 baguettes  
inox pulido brillante, ideal para hasta 7 bocadillos  
inox poli brillant, parfait jusque maxi 7 sandwiches

	cm	↑ cm
11891	47,5 x 10,5	6

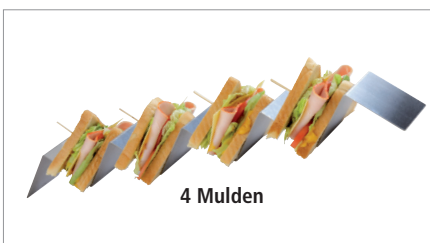

**Snackpresenter**

snackpresenter  
dispensador de bocadillos  
présentoir à sandwiches



	cm	↑ cm
11969	56 x 8	5,5

# Brotstation



83615  
Tablett

00954  
Box

00953  
Schneidebrett



## Tablett „BROTSTATION“

tray  
bandeja  
plateau



### Antirutsch-Füßchen

non-slip feet  
pies antideslizantes  
pieds antiglisse

	cm	↑ cm
83615	59,5 x 35,5	3,5

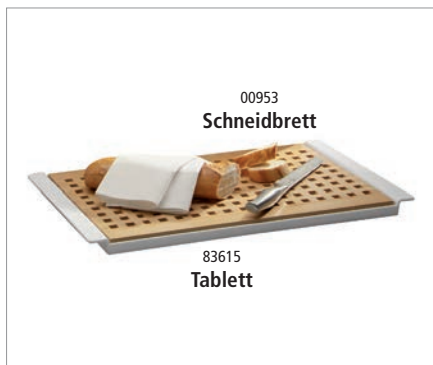

00953  
Schneidebrett

83615  
Tablett

## Brotschneidebrett „BROTSTATION“

cutting board  
tabla de corte  
planche à découper



### Buchen-Holz

beech  
haya  
hêtre

	cm	↑ cm
00953	52 x 34	2

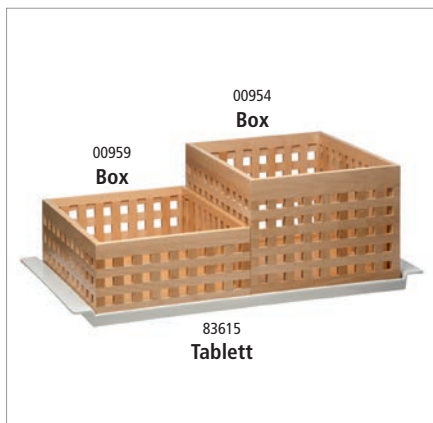

00959  
Box

00954  
Box

83615  
Tablett

## Box „BROTSTATION“

box  
caja de pan para el buffet  
boîte à pain pour le buffet



### Buchen-Holz

beech  
haya  
hêtre

	cm	↑ cm
00959	34 x 26	12,5
00954	34 x 26	20,0





NEW

**Buffetbrett „PROFI“**  
board  
tabla para el buffet  
planche découper buffet



	cm	↑ cm	
00806	58 x 37,5	4	



**Brotschneidebrett „LETTER“**  
cutting board  
tabla para cortar  
planche à découper



	cm	↑ cm	
00886	48 x 34	3,5	



**Brotschneidebrett „AKAZIA“**  
cutting board  
tabla para cortar  
planche à découper



	cm	↑ cm	GN
00883	47,5 x 32,0	2	
00884	53,0 x 32,5	2	1/1
00885	60,0 x 40,0	2	



**praktisches Krümfach**  
practical crump shelf



**Brotschneidebrett „RUBBERWOOD“**  
cutting board  
tabla para cortar  
planche à découper



	cm	↑ cm	GN
00955	47,5 x 32,0	2	
00956	53,0 x 32,5	2	1/1
00957	60,0 x 40,0	2	



**Brotschneidebrett, 2-tlg.**  
cutting board, 2 pcs.  
tabla para cortar, set de 2  
planche à découper, set de 2



**2-tlg. Set, GN 1/1 Behälter, 20 mm tief, dient als Krümfach**  
2 pcs. set, GN 1/1 pan 20 mm, bread crump shelf  
set de 2: tabla de corte + bandeja inox GN 1/1 alt 20 mm (sirve para recoger las migas)  
set de 2: planche à découper bois + plateau inox GN 1/1 Ht 20 mm (sert de ramassemies)

	cm	GN
00951	53 x 32,5	1/1

**einzelnes Brett / separate board / tabla por separado / planche seule**

	cm	GN
00952	53 x 32,5	1/1



**Cerealienspender**

cereal dispenser  
dispensador de cereales  
distributeur de céréales



**Behälter herausnehmbar, portionieren durch einfaches Drehen**  
removable canister, easy to use, rotate the button to get the muesli  
contenedor movable, fácil de usar, se gira el pomo para servir los cereales  
réceptif amovible, usage facile en tournant le bouton

	cm	↑ cm	ltr.	Farbe / Colour
12050	24 x 17,5	49,5	4,5	White
12051	24 x 17,5	49,5	4,5	Black



**Cerealienspender „DUO“**

cereal dispenser  
dispensador de cereales  
distributeur de céréales



**Behälter herausnehmbar, portionieren durch einfaches Drehen**  
removable canister, easy to use, rotate the button to get the muesli  
contenedor movable, fácil de usar, se gira el pomo para servir los cereales  
réceptif amovible, usage facile en tournant le bouton

	cm	↑ cm	ltr.	Farbe / Colour
12054	24 x 37,5	49,5	2 x 4,5	White
12055	24 x 37,5	49,5	2 x 4,5	Black





**Buffetständer „GOOD MORNING“**

buffet stand  
expositor de buffet  
présentoir de buffet

HOLZ  
WOOD

GLAS  
GLASS



4-teiliges Set: Holzständer inkl. 3 Gläser mit luftdichtem Klappdeckel

4 pcs. set: wood stand included 3 glass with airtight cover

set de 4: soporte, 3 boles de cristal, cierre hermético

set de 4: présentoir, 3 bols en verre, fermeture hermétique

	cm	Farbe / Colour
13965	43 x 17	
14965	43 x 17	

Glas mit luftdichtem Klappdeckel / glass with airtight cover / cristal, cierre hermético / verre, fermeture hermétique

	cm	↑ cm	ltr.
82328	12 x 12	22	2



**Cerealienspender „FRESH & EASY“**

cereal dispenser  
dispensador de cereales  
distributeur de céréales

SAN  
KUNSTSTOFF

SILIKON  
SILICON

GUSS  
ZINK

EDELSTAHL  
STAINLESS  
INOX

Behälter herausnehmbar, „Feierabend-Deckel“ für das aromadichte Lagern, portionieren durch einfaches Drehen

removable canister, special lid to keep the cereals fresh, easy to use, rotate the button to get the muesli

contenedor movable, tapa especial para mantener los cereales frescos,

fácil de usar, se gira el pomo para servir los cereales

réipient amovible, couvercle spécial pour conserver les céréales, usage facile en tournant le bouton

	cm	↑ cm	ltr.
11805	22 x 17,5	52	4,5



**Cerealienspender Duo „FRESH & EASY“**

cereal dispenser  
dispensador de cereales  
distributeur de céréales

SAN  
KUNSTSTOFF

SILIKON  
SILICON

GUSS  
EISEN

EDELSTAHL  
STAINLESS  
INOX

Behälter herausnehmbar, „Feierabend-Deckel“ für das aromadichte Lagern, portionieren durch einfaches Drehen

removable canister, special lid to keep the cereals fresh, easy to use, rotate the button to get the muesli

contenedor movable, tapa especial para mantener los cereales frescos, fácil de usar, se gira el pomo

para servir los cereales

réipient amovible, couvercle spécial pour conserver les céréales, usage facile en tournant le bouton

	cm	↑ cm	ltr.
11807	22 x 35	52	2 x 4,5

Kunststoffbehälter / canister / contenedor / réipient

	Ø cm	ltr.
11808	24	4,5



**Cerealienspender „CLASSIC“**

cereal dispenser  
dispensador de cereales  
distributeur de céréales

SILIKON  
SILICON

PC  
POLYCARB.

EDELSTAHL  
STAINLESS  
INOX  
18/8

Portionieren durch einfaches Drehen, Behälter herausnehmbar

canister removable

contenedor movable

réipient amovible

	cm	↑ cm	ltr.
11833	35 x 26,5	68	8

## Buffet & Display



### Cerealispender „CLASSIC DUO“

cereal dispenser  
dispensador de cereales  
distributeur de céréales



Portionieren durch einfaches Drehen, Behälter herausnehmbar

canister removable  
contenedor movable  
récipient amovible

	cm	↑ cm	ltr.
11834	35 x 50	68	2 x 8



### Cerealispender „BRIDGE“

cereal dispenser  
dispensador de cereales  
distributeur de céréales



Behälter herausnehmbar, „Feierabend-Deckel“ für das aromadichte Lagern, portionieren durch einfaches Drehen

removable canister, special lid to keep the cereals fresh, easy to use, rotate the button to get the muesli

contenedor movable, tapa especial para mantener los cereales frescos, fácil de usar, se gira el pomo para servir los cereales

récipient amovible, couvercle spécial pour conserver les céréales, usage facile en tournant le bouton

	cm	↑ cm	ltr.	Farbe / Colour
13987	21 x 20	55,5	4,5	Ahorn
14987	21 x 20	55,5	4,5	Wenge



### Cerealispender „ROTATION“

cereal dispenser  
dispensador de cereales  
distributeur de céréales



matt poliert, drehbarer massiver Ständer, Behälter herausnehmbar, inkl. Frischhaltedeckel

satín polished finish, rotating food, canister removable, incl. airtight covers

pulido acabado satinado, giratorio, incluye tapas herméticas

mat satiné, rotatif, inclut couvercles hermétiques

	Ø cm	↑ cm	ltr.
11970	38	54	3 x 4,5

Kunststoffbehälter / canister / contenedor / récipient

11808



### Cerealispender „ROTATION“

cereal dispenser  
dispensador de cereales  
distributeur de céréales



Buchen-Holz versiegelt, drehbarer massiver Ständer, Behälter herausnehmbar, inkl. Frischhaltedeckel

wood beech covered waterproof, rotating foot, canister removable, incl. airtight cover

tapa en madera de haya resistente al agua, pie giratorio, recipiente removable, incluye tapa hermética

couvercle en hêtre traitée contre l'humidité, pied rotatif, récipients démontables, inclut couvercles hermétiques

	Ø cm	↑ cm	ltr.
11975	38	54	3 x 4,5

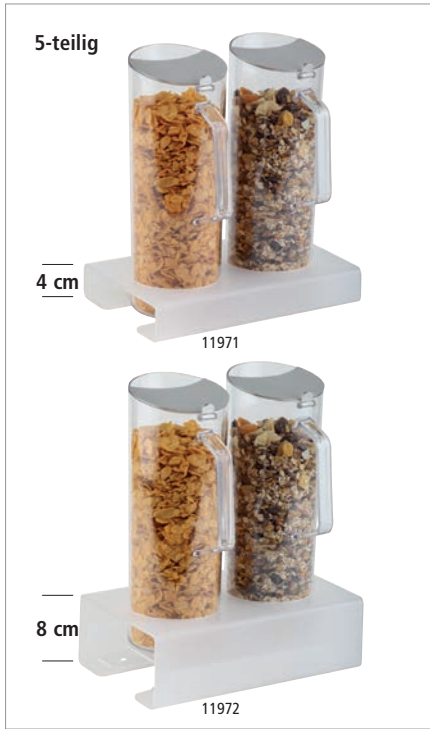

**Cerealien-Bar**

cereal-bar  
barra para dispensador de cereales  
bar à céréales



5-teiliges Set, mit Ständerhöhe 4 oder 8 cm: 1 Ständer aus Acryl gefrostet und rutschfest + 2 Karaffen mit schwenkbarem Edelstahl-Deckel + 2 luftdichte Frischhaltedeckel

5 pcs. set, with stand heights 4 or 8 cm: 1 stand acryl frosted and anti-slip + 2 pitchers with stainless steel flap lid + 2 airtight covers

set de 5: stands a diferentes alturas, 4 u 8 cm: 1 stand acryl + 2 jarras con tapa de solapa de acero inoxidable + 2 tapas herméticas adicionales

set de 5: supports à différentes hauteurs: 4 ou 8 cm - 1 support acrylique satiné antiglisse + 2 pichets à céréales avec couvercle à charnière inox + 2 couvercles hermétiques

	cm	↑ cm	ltr.
11971	26 x 17	28,5	2 x 1,5
11972	26 x 17	32,5	2 x 1,5



ideal für Stufenpräsentation  
best for staged presentations



**Cerealien-Bar**

cereal-bar  
barra para dispensador de cereales  
bar à céréales



7-teiliges Set, mit Ständerhöhe 4 oder 8 cm: 1 Ständer aus Acryl gefrostet und rutschfest + 3 Karaffen mit schwenkbarem Edelstahl-Deckel + 3 luftdichte Frischhaltedeckel

7 pcs. set, with stand heights 4 or 8 cm: 1 stand acryl frosted and anti-slip + 3 pitchers with stainless steel flap lid + 3 airtight covers

set de 7: con stands a diferentes alturas, 4 u 8 cm: 1 stand acryl + 3 jarras con tapa de solapa de acero inoxidable + 3 tapas herméticas adicionales

set de 7: supports à différentes hauteurs: 4 ou 8 cm - 1 support acrylique satiné antiglisse + 3 pichets à céréales avec couvercle à charnière inox + 3 couvercles hermétiques

	cm	↑ cm	ltr.
11973	38 x 17	28,5	3 x 1,5
11974	38 x 17	32,5	3 x 1,5



ideal für Stufenpräsentation  
best for staged presentations



**Cerealienkaraffe**

cereal pitcher  
jarra de cereales  
pichet à céréales



schwenkbarer Edelstahl-Deckel, inkl. luftdichtem Frischhaltedeckel

stainless steel flap lid, incl. 1 airtight cover

tapa de solapa de acero inoxidable, incluye otra tapa hermética

couvercle à charnière inox + couvercle hermétique

	Ø cm	↑ cm	ltr.
10778	10	28	1,5

Frishhaltedeckel / conservation lid / tapa de conservación / couvercle

10668

# SERVICE TOWER



## Service Tower

service tower  
service tower  
tour de service



Präsentations- und Spendersystem, bei minimalen Platzbedarf, optimale Wertschöpfung, zum Beispiel im Bereich der Besteckausgabe, Kaffeestationen, Speiseausgaben, Verkaufstheken, etc., Rückwand aus dunklem Holz oder Acryl gefrostet

Presentation and dispenser system, the products find their best creation of value at minimal need of space, for example in the range of coffeestations, food service, counters etc., backplane made of dark wood or acrylic frosted

sistema de presentación y dispensador, con el mínimo espacio conseguirá una excelente presentación de sus productos, por ejemplo en la zona del café, comidas, etc., trasera de madera oscura o de acrílico opaco mate

système de présentation et distribution, très élégant dans un espace minimum, idéal pour la zone café, coin repas, etc., paroi en bois foncé ou en acrylique mat

	cm	↑ cm	Farbe / Colour	
11431	26 x 18	43	■	2x Schütte, tief + 1x Schütte, flach 2 deep ones + 1 flat one 2 rampas hondas + 1 plana / 2 rampas profundes + 1 plates
11432	26 x 18	43	■	3x Schütte, tief / 3 bowls, deep ones 3 rampas hondas / 3 rampas profundes
11422	26 x 18	57,5	■	4x Schütte, tief / 4 bowls, deep ones 4 rampas hondas / 4 rampas profundes

	cm	↑ cm	Farbe / Colour	
11433	26 x 18	43	■	2x Schütte, tief + 1x Schütte, flach / 2 deep ones + 1 flat one / 2 rampas hondas + 1 plana / 2 rampas profundes + 1 plate
11434	26 x 18	43	■	3x Schütte, tief / 3 bowls, deep ones 3 rampas hondas / 3 rampas profundes
11424	26 x 18	57,5	■	4x Schütte, tief / 4 bowls, deep ones 4 rampas hondas / 4 rampas profundes



## Basisfuss / base / pie de la base / pied de la base

11435

## Rückwand Holz / backplane made of wood / trasera de madera / arrière bois

	cm	
11436	44,5 x 24	für 3 Schütten
11426	60,0 x 24	für 4 Schütten

## Rückwand Acryl / backplane made of acrylic / trasera acrílica / arrière acrylique

	cm	
11437	44,5 x 24	für 3 Schütten
11427	60,0 x 24	für 4 Schütten

## Schütte, tief / bowl, deep / rampa, honda / rampe profonde

	cm	↑ cm
11438	22 x 14	7 / 5

## Schütte, flach / bowl / rampa plana / rampe plate

	cm	↑ cm
11439	22 x 13	3 / 1

# MULTI RACK



**Multi Rack**  
multi rack  
dispensador en escalera  
support multiple



**2-stufig, 3-teilig: 1 Gestell matt poliert + 2 Schütten aus transparent gefrostedem Kunststoff, je ca. 1 Liter**

2-tier, 3 pcs. set: 1 frame satin polished finish + 2 bowls frosted plastic, approx. 1 liter  
2 alturas - set de 3: 1 soporte inox mate satinado + 2 bols plástico glaseado, aprox. 1 litro  
2 niveaux - set de 3: 1 support satiné + 2 bols plastique mat, approx. 1 litre

	cm	↑ cm
11442	19 x 24	28



**Multi Rack**  
multi rack  
dispensador en escalera  
support multiple



**3-stufig, 4-teilig: 1 Gestell matt poliert + 3 Schütten aus transparent gefrostedem Kunststoff, je ca. 1 Liter**

3-tier, 4 pcs. set: 1 frame satin polished finish, + 3 bowls frosted plastic, approx. 1 liter  
3 alturas, set de 4: 1 estructura inox satinado, + 3 bols de plástico glaseado, aprox. 1 litro  
3 niveaux - set de 4: 1 structure inox poli satin, + 3 bols plastique mat, approx. 1 litre

	cm	↑ cm
11444	19 x 24	41



**Multi Rack**  
multi rack  
dispensador en escalera  
support multiple



**3-stufig, 4-teilig: 1 Gestell matt poliert + 1 Schütte aus transparent gefrostedem Kunststoff, ca. 1 Liter + 2 Rutschen aus transparent gefrostedem Kunststoff**

3-tier, 4 pcs. set: 1 frame satin polished finish + 1 bowl frosted plastic, approx. 1 liter + 2 slides frosted plastic  
3 alturas, set de 4: 1 soporte inox satinado + 1 bol de plástico glaseado, aprox, 1 litro + 2 bols con „tobogán“ en plástico glaseado  
3 niveaux - set de 4: 1 structure inox poli satin + 1 bol plastique mat approx. 1 litre + 2 bols avec „toboggan“

	cm	↑ cm
11449	19 x 24	41



**Multi Rack**  
multi rack  
dispensador en escalera  
support multiple



**4-stufig, 5-teilig: 1 Gestell matt poliert + 4 Schütten aus transparent gefrostedem Kunststoff, je ca. 1 Liter**

4-tier, 5 pcs. set: 1 frame satin polished finish + 4 bowls frosted plastic, approx. 1 liter  
4 alturas, set de 5: 1 estructura inox satinado + 4 bols de plástico glaseado, aprox. 1 litro  
4 niveaux - set de 5: 1 structure inox poli satin, 4 bols plastique mat, approx. 1 litre

	cm	↑ cm
11446	19 x 31	53



**Multi Rack**

multi rack  
dispensador en escalera  
support multiple



4-stufig, 5-teilig: 1 Gestell matt poliert + 3 Schütten aus transparent gefroretetem Kunststoff, je ca. 1 Liter + 1 Rutsche aus transparent gefroretetem Kunststoff

4-tier, 5 pcs. set: 1 frame satin polished finish + 3 bowls frosted plastic, approx. 1 liter + 1 slide frosted plastic

4 alturas, set de 5 piezas: 1 estructura inox satinado + 3 bols de plástico glaseado, aprox. 1 litro + 1 bol con „tobogán“ de plástico efecto glaseado

4 niveaux - set de 5 éléments: 1 structure inox poli satin + 3 bols plastique mat approx. 1 litre + 1 bol avec „toboggan“

	cm	↑ cm
11451	19 x 31	53



Schütte

**Ergänzung für alle Multi-Racks**

supplement for all multi racks  
suplemento para todos los dispensadores  
compléments pour support Multi-Rack



11455	Schütte / canister / bol / bol	
-------	--------------------------------	--



Rutsche

**Ergänzung für alle Multi-Racks**

supplement for all multi racks  
suplemento para todos los dispensadores  
compléments pour support Multi-Rack



11456	Rutsche / slide / tobogan / toboggan	
-------	--------------------------------------	--

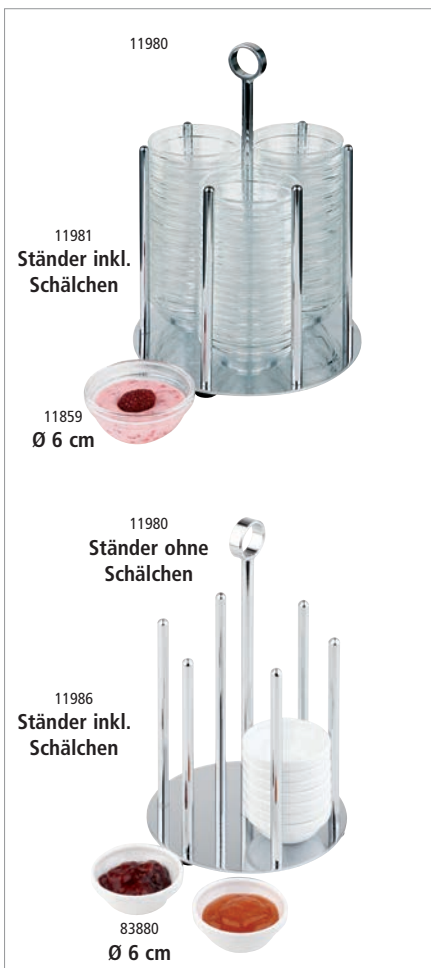

**Schälchenspender „MINI“**

bowl holder  
rack dispensador para bols  
porte-bols



geeignet für Schalen Ø 6 cm, bestückbar mit bis zu 36 Schalen

for bowls Ø 6 cm, suitable for 36 bowls

para bols de Ø 6 cm, apto para 36 bols

pour bols de Ø 6 cm, maxi 36 bols

	Ø cm	↑ cm	
11981	14	25,5	Ständer inkl. 36 Glasschalen, Ø 6 cm / frame with 36 bowls, Ø 6 cm soporte con 36 bols, Ø 6 cm / support livré avec 36 bols en verre Ø 6 cm
11986	14	25,5	Ständer inkl. 36 Melaminschalen, Ø 6 cm / frame with 36 melamine bowls, Ø 6 cm soporte con 36 bols de melamina Ø 6 cm / support avec 36 bols en mélamine Ø 6 cm

**Schälchenspender „MINI“ / bowl holder / rack dispensador para bols / porte-bols**

	Ø cm	↑ cm	
11980	14	25,5	Ständer ohne Schalen / frame without bowls soporte sin bols / support sans bols



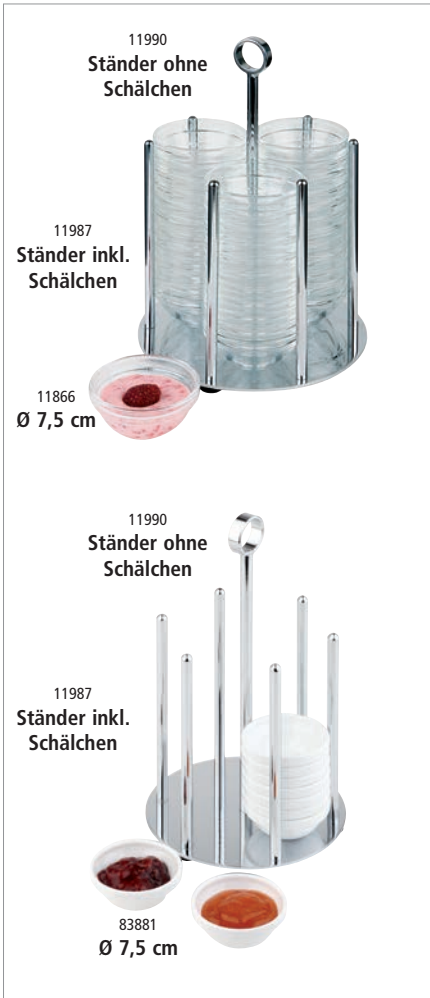

**Schälchenspender „MEDIUM“**

bowl holder  
rack dispensador para bols  
porte-bols



geeignet für Schalen Ø 7,5 cm, bestückbar mit bis zu 36 Schalen  
for bowls Ø 7,5 cm, suitable for 36 bowls  
para bols de Ø 7,5 cm, apto para 36 bols  
pour bols de Ø 7,5 cm, maxi 36 bols

	Ø cm	↑ cm	
11991	17,5	25,5	Ständer inkl. 36 Glasschalen, Ø 7,5 cm / frame with 36 bowls, Ø 7,5 cm / soporte con 36 bols, Ø 7,5 cm / support livré avec 36 bols en verre Ø 7,5 cm
11987	17,5	22,5	Ständer inkl. 36 Melaminschalen, Ø 7,5 cm / frame with 36 melamine bowls, Ø 7,5 cm / soporte con 36 bols de melamina, Ø 7,5 cm / support avec 36 bols en mélamine Ø 7,5 cm

**Schälchenspender „MEDIUM“ / bowl holder / rack dispensador para bols / porte-bols**

	Ø cm	↑ cm	
11990	17,5	25,5	Ständer ohne Schalen / frame without bowls / soporte sin bols / support sans bols



**Schälchen „CASUAL MINI“**

bowl  
cuenco  
bol mini



	Ø cm	↑ cm	ltr.
83880	6,0	2,5	0,02
83881	7,5	3,5	0,05



**Schale**

bowl  
cuenco  
bol



	Ø cm	↑ cm	ltr.	pcs.
11859	6,0	2,5	0,05	36
11866	7,5	3,5	0,09	36

## Buffet & Display



### Vorratsglas „WOODY“

canister with lid  
bote con tapa  
pot en verre avec couvercle



**Holzdeckel mit Silikondichtung**  
wooden lid with silicone gasket



**Glasbehälter mit Holzdeckel, aromadichter Verschluss**

glass container, aroma-tight screw cap

recipiente de cristal, tapa con cierre hermético para conservar el aroma

réipient en verre, couvercle avec fermeture hermétique pour conserver l'arôme

	cm	↑ cm	ltr.
82255	14 x 14	11,0	1,0
82256	14 x 14	17,0	2,0
82257	14 x 14	21,5	2,5



### Vorratsglas „CLASSIC“

canister with lid  
bote con tapa  
pot en verre avec couvercle



**inkl. Glasdeckel mit Dichtung. Somit bleibt Ihre Ware frisch**

incl. glass lid with seal. Thus, your goods remain fresh

incl. tapa de vidrio con junta. Por lo tanto, sus productos permanecen frescos

y compris couvercle en verre avec joint. Ainsi, vos marchandises restent fraîches

	Ø cm	↑ cm	ltr.
82250	11,5	16,0	0,9
82251	14,0	21,5	2,0
82252	18,0	26,0	4,0
82253	20,0	30,0	6,0



2 ltr.

**Vorratsglas mit luftdichtem Klappdeckel**

glass with airtight cover  
bote con cierre hermético  
pot en verre avec fermeture hermétique



	cm	↑ cm	ltr.
82328	12 x 12	22	2



3 ltr.

inkl. Löffel

**Vorratsglas**

canister with lid  
bote con tapa  
pot en verre avec couvercle



**Glaskugel mit Löffel, Schraubdeckel mit aromadichtem Verschluss, Edelstahl-Löffel mit magnetischem Silikongriff, 1 Stck.**  
tight cover, stainless steel spoon with magnetic silicone handle, 1 pc.  
tapa a rosca con cierre hermético, cuchara de acero inoxidable con mango de silicona magnético, 1 pza  
couvercle à vis avec fermeture hermétique, cuillère en acier inox avec manche de silicone aimanté, 1 pc.

	Ø cm	↑ cm	ltr.
00636	20	18	3



1 ltr.

**Vorratsglas**

canister with lid  
bote con tapa  
pot en verre avec couvercle



**Glaskugel mit Schraubdeckel, aromadichtem Verschluss, 1 Stck.**  
glass ball, aroma-tight screw cap, 1 pc.  
bote de cristal, tapa a rosca para conservar el aroma, 1 pza  
pot en verre, couvercle à vis pour conserver l'arôme, 1 pc.

	cm	↑ cm	ltr.
00637	12,5 x 19	18	1

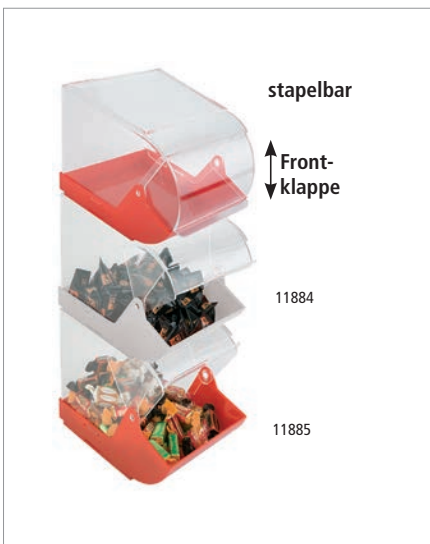

stapelbar

↑ Front-klappe

11884

11885

**Universalbox**

box / sweetbox  
caja dispensadora  
boîte distributrice



**ideal als Verkaufsbox, mit Frontdeckel**  
best to present sweets etc., all-purpose, with front lid  
la perfecta solución para presentar golosinas, universal, con tapa frontal  
la solution idéale pour les friandises et autres, universel, avec couvercle frontal

	cm	↑ cm	Farbe / Colour
11884	23 x 14,5	15	White
11885	23 x 14,5	15	Red

## Buffet & Display



**Hygieneschutz**  
hygienic cover  
cubierta higiénica antialiento  
pare-haleine



	cm	↑ cm
11556	82 x 42	45



**Brötchenspender**  
roll dispenser  
dispensador de panecillos  
distributeur de petits pains



**hygienisch und einfach zu reinigen, mit Krümelschale**  
hygienic and easy to clean, with crumb tray  
higiénico y fácil de limpiar, con bandeja para migas  
hygiénique et facile à laver, avec plat ramasse-miettes

	cm	↑ cm	
11572	32,5 x 27,5	42	für ca. 45 - 50 Brötchen / for approx. 45 - 50 rolls para 45-50 panecillos / pour 45-50 petits pains
11573	32,5 x 27,5	56	für ca. 65 - 70 Brötchen / for approx. 65 - 70 rolls para 65-70 panecillos / pour 65-70 petits pains

Deckel / Cover / tapa / couvercle seul

	cm	↑ cm
11562	33,5 x 21,5	4



**Universalbox**  
universal box  
caja dispensadora  
boît distributrice



**ideal für Zucker, Milch und Gebäck, 3 Fächer**  
best for sugar, milk and biscuits, 3 compartments  
la perfecta solución para a azúcar, leche y galletas, 3 compartimentos  
la solution idéale pour sucre, lait et biscuits, 3 compartiments

	cm	↑ cm
11886	41,5 x 20,5	16



**Teebox / Multibox**  
tea caddy  
caja para té  
boîte à thés et infusions



**3 Fächer für kuvertierte Teebeutel, 1 Fach für Zucker, Kekse, etc., Deckel aufklappbar**  
4 chambers  
4 compartimentos  
4 compartiments

	cm	↑ cm
11563	22 x 17	9



**Teebox „VINTAGE“**

tea-box  
caja para té  
boîte à thés et infusions



**Holzbox mit Sichtfenster, 4 Kammern können mit je 30 kuvertierten Teebeuteln bestückt werden**

wooden box with clear transparent window, 4 chambers for approx. 30 tea bags each  
caja de madera clara con ventana transparente, 4 compartimentos, para aproximadamente 30 bolsas de té  
en bois clair avec fenêtre, 4 compartiments, pour environ 30 sachets

	cm	↑ cm	Farbe / Colour
11570	32 x 20	10	■



**Teebox „VINTAGE“**

tea-box  
caja para té  
boîte à thés et infusions



**Holzbox mit Sichtfenster, 4 Kammern können mit je 30 kuvertierten Teebeuteln bestückt werden**

wooden box with clear transparent window, 4 chambers for approx. 30 tea bags each  
caja de madera clara con ventana transparente, 4 compartimentos, para aproximadamente 30 bolsas de té  
en bois clair avec fenêtre, 4 compartiments, pour environ 30 sachets

	cm	↑ cm	Farbe / Colour
11571	32 x 20	10	■



**Teebox**

tea-box  
caja para té  
boîte à thés et infusions



**Holzbox mit Sichtfenster, mit Aufschrift „Tee“, 4 Kammern können mit je 30 kuvertierten Teebeuteln bestückt werden**

wooden box with clear transparent window, with inscription „Tee“, 4 chambers for approx. 30 tea bags each  
caja de madera clara con ventana transparente, con inscripción „Tee“, 4 compartimentos, para aproximadamente 30 bolsas de té  
en bois clair avec fenêtre, marquée „TEE“, 4 compartiments, pour environ 30 sachets

	cm	↑ cm	Farbe / Colour
11575	33,5 x 20	9	■
11574	33,5 x 20	9	■

	cm	↑ cm	Farbe / Colour	
11576	33,5 x 20	9	■	ohne Aufschrift / without inscription sin inscripción / sans inscription



**Teebox**

tea-box  
caja para té  
boîte à thés et infusions



**Holzbox mit Sichtfenster, mit Aufschrift „Tee“, 12 Kammern können mit je 12 kuvertierten Teebeuteln bestückt werden**

wooden box with clear transparent window, with inscription „Tee“, 12 chambers for approx. 144 tea bags each  
caja de madera clara con ventana transparente, con inscripción „Tee“, 12 compartimentos, para aproximadamente 144 bolsas de té  
en bois clair avec fenêtre, marquée „TEE“, 12 compartiments, pour environ 144 sachets

	cm	↑ cm	Farbe / Colour
11775	31 x 28	9	■
11776	31 x 28	9	■

## Buffet & Display

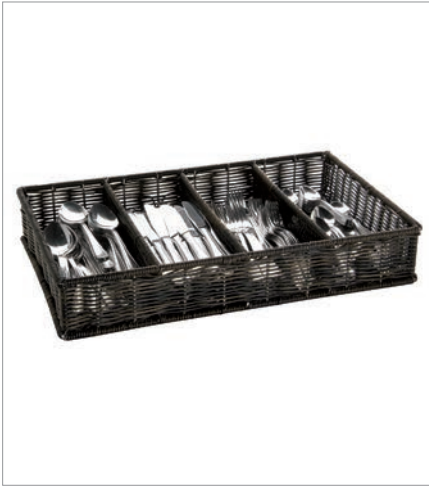

### GN 1/1 Besteckbehälter

GN 1/1 dispenser GN  
GN 1/1 dispensador de cubiertos  
GN 1/1 bac à couverts



in Handarbeit geflochten, 4 Mulden, Kunststoff-Geflecht, Drahtgestell, braun-schwarz

wickerwork, 4 compartments, with reinforced chromed wire structure, brown-black

cesta trensada a mano, 4 compartimentos, de plástico, con bastidor cromado reforzado, marrón oscuro

corbeille tressée à main, 4 compartiments, en plastique, cadre acier chromé renforcé, couleur marron foncé

	cm	↑ cm	Farbe / Colour
11966	53 x 32,5	9	



### GN 1/1 Besteckbehälter „BUFFET“

GN 1/1 cutlery dispenser  
GN 1/1 dispensador de cubiertos  
GN 1/1 bac à couverts



4 Mulden, Kunststoff-Geflecht, Drahtgestell, beige

4 troughs, wickerwork, wire, beige

4 huecos, trabajo de cestería

4 compartiments, plastique tressé, cadre acier chromé renforcé, couleur osier naturel

	cm	↑ cm	Farbe / Colour
11965	53 x 32,5	10	



### GN 1/1 Besteckbehälter

GN 1/1 cutlery tray / box stand  
GN 1/1 dispensador de cubiertos  
GN 1/1 bac à couverts



	cm	↑ cm	Farbe / Colour
11955	53 x 32,5	10	



### GN 1/1 Besteckkasten

cutlery box GN 1/1  
GN 1/1 dispensador de cubiertos  
GN 1/1 bac à couverts



	cm	↑ cm	Farbe / Colour
11960	53 x 32,5	10	





**Besteckköcher**  
cutlery basket  
cesta para cubiertos  
corbeille à couverts



	Ø cm	↑ cm	
11998	9,7	13,7	Kunststoff weiß / white plastic plástico blanco / plastique blanc
11999	9,7	13,7	matt poliert / satin polished finish acero inoxidable / inox

11998  
Köcher weiß  
PE white

11999  
Köcher Edelstahl  
stainless steel



**Besteckbehälter**  
cutlery basket  
dispensador de cubiertos  
présentoir à couverts



**matt poliert**  
satin polished finish  
inox mate (sin cubiertos)  
inox mat

	cm	↑ cm	
11994	26,0 x 30 Ø 10	20	4 Löcher inkl. Köcher (Kunststoff) 4 holes incl. dispensers (plastic) 4 agujeros incl. dispensador plástico 4 places, avec 4 récipients (plastique)
11997	37,5 x 30 Ø 10	20	6 Löcher ohne Köcher 6 holes without dispensers 6 agujeros sin dispensador de plástico 6 places, sans récipients

11994

11997



**Besteckbehälter**  
cutlery basket  
recipiente para cubiertos  
récipients pour couverts



**4 Löcher inkl. 4 Edelstahl Köcher**  
4 holes incl. 4 stainless baskets  
4 agujeros, incl. 4 cestas de acero  
4 places, avec 4 corbeilles inox

	cm	↑ cm	Farbe / Colour
93321	27 x 27	15	



**Besteckbehälter „ELEMENT“**  
cutlery bin  
recipiente para cubiertos  
récipients pour couverts



**mit Abflussloch, mit Besteck Logo, Bodeneinlage aus Silikon zum Schonen des Bestecks, möbelschonende Unterseite**  
with drain hole, with cutlery logo, silicone floor insert for saving the cutlery, with non-scratching undersurface  
con orificio de drenaje, con logotipo de cubertería, base de silicona para proteger la cubertería, con base anti rayaduras  
avec trou de drainage, avec logo de coutellerie, insert de silicone pour protéger la coutellerie, avec revêtement antirayures

	Ø cm	↑ cm
00018	11	14



## Besteckbehälter „ELEMENT“

cutlery bin  
recipiente para cubiertos  
récipients pour couverts



mit Abflussloch, mit weißem Logo, Bodeneinlage aus Silikon zum Schonen des Bestecks, möbelschonende Unterseite  
with drain hole, with white logo, silicone floor inserts for saving the cutlery, with non-scratching undersurface  
con orificio de drenaje, con logotipo blanco, base de silicona para proteger la cuberteria, con base anti rayaduras  
avec trou de drainage, avec logo blanc, insert de silicone pour proteger la coutellerie, avec revêtement antirayures

	∅ cm	↑ cm	Logo
11935	12	14	fork
11936	12	14	knife
11937	12	14	spoon



## Besteckbehälter „ACACIA“

cutlery bin  
recipiente para cubiertos  
récipients pour couverts



Akazienholz natur  
acacia wood nature  
madera de acacia natural  
bois d'acacia naturelle

	cm	↑ cm	Logo
11939	14 x 14	15	fork / knife / spoon

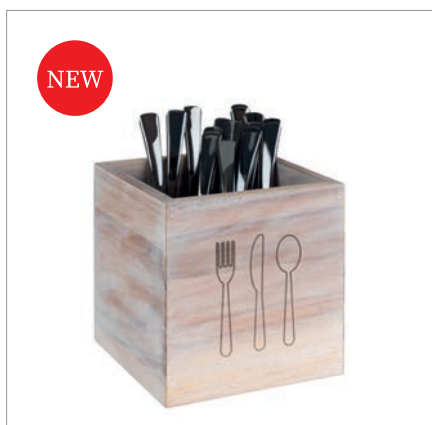

## Besteckbehälter „VINTAGE“

cutlery bin  
recipiente para cubiertos  
récipients pour couverts



Akazienholz vintage weiß  
acacia wood, vintage white  
madera de acacia, blanca vintage  
bois d'acacia, blanc vintage

	cm	↑ cm	Logo
11938	14 x 14	15	fork / knife / spoon





**Tischrestehälter**  
table garbage bin  
papelera de sobremesa  
poubelle de table



	Ø cm	↑ cm	ltr.	Farbe / Colour
02038	11	14	0,9	White
02039	11	14	0,9	Black



**Tischrestehälter „INTERNATIONAL“**  
table waste bin  
papelera de sobremesa  
poubelle de table



**Deckel-Ring mit Dichtung, internationale Beschriftung**  
cover with sealing ring  
tapa con junta, texto multi-idomas  
couvercle avec joint, texte multilingue

	Ø cm	↑ cm	ltr.
83847	10	17,5	1



**Tischrestehälter**  
table garbage bin  
papelera de sobremesa  
poubelle de table



**Behälter aus weiß lackiertem Metall, abnehmbarer Schwingdeckel**  
cover stainless steel bin metal, white, swing cover  
tapa de acero inoxidable, recipiente chapa lacada blanca  
couvercle inox basculant, récipient en acier laqué blanc

	Ø cm	↑ cm	ltr.
00291	12	17	1,2



**Tischrestehälter**  
table garbage bin  
papelera de sobremesa  
poubelle de table



**Behälter aus weiß lackiertem Metall, Edelstahl-Lochdeckel**  
metall white, stainless cover with hole  
tapa, acero inoxidable, con apertura  
couvercle inox, avec ouverture centrale, récipient en acier laqué blanc

	Ø cm	↑ cm	ltr.
00292	12	15	1,2



**Tischrestehälter „SUNDAY“**  
table waste bin  
papelera de sobremesa  
poubelle de table



**matt poliert, inkl. Deckel, fester Deckelsitz**  
satin polished finish, incl. cover, cover removeable  
acero inoxidable mate, con tapa  
inox mat, avec couvercle

	Ø cm	↑ cm	ltr.
00024	10	18	1,1



**Tischrestebehälter**

table garbage bin  
papelera de sobremesa  
poubelle de table



**Behälter (innen Ø 9 cm) für Besteck, Servietten etc., vielseitig einsetzbar**  
bins (inner Ø 9 cm) for cutlery, napkins etc., versatile applicable  
recipientes Ø 9 cm para cubiertos, servilletas etc.  
récipients Ø 9 cm, pour couverts, serviettes,...

	Ø cm	↑ cm	ltr.
83999	13	14	1,2



**Tischreste- / Besteckbehälter**

table garbage bin / cutlery bin  
papelera de sobremesa / recipiente para cubiertos  
poubelle de table / récipients pour couverts



**matt poliert, mit abnehmbaren Lochdeckel**  
satin polished finish, with removable cover  
acabado pulido satinado, con tapa desmontable  
poli mat satiné, avec couvercle démontable ouvert au centre

	Ø cm	↑ cm	ltr.
00028	10	12	0,7



**Tischrestebehälter**

table garbage bin  
papelera de sobremesa  
poubelle de table



**matt poliert, abnehmbarer Schwingdeckel, mit Bajonettverschluss „fester Deckelsitz“**  
satin polished finish, swing cover, cover removable  
acabado satinado, tapa basculante desmontable  
poli mat satiné, couvercle basculant démontable

	Ø cm	↑ cm	ltr.
00029	12	17	1,2
00027	10	13	0,7



**Table Caddy „COUNTRY STYLE“**

table barrel  
caddy de mesa  
caddy de table



**cooler Country-Style, nicht für den direkten Kontakt mit Lebensmittel verwendbar**  
make for cool condiment and cutlery holders or even for food presentation, the mini barrels should not come into contact with food, they should be lined with our greaseproof paper  
estilo campo, no aptos para el contacto directo con alimentos, sólo usando papel alimenticio  
de style champêtre, pas de contact direct avec aliments, seulement en utilisant papier alimentaire

	Ø cm	↑ cm
11930	17,5	8,5
11931	11,5	14,0





**Tischreste- / Besteckbehälter „TOP CHROME“**

table waste bin / cutlery bin  
 papelera de sobremesa / recipiente para cubiertos  
 poubelle de table / récipients pour couverts



mit verchromten Rand  
 with chrome plated ring  
 con anillo cromado  
 avec bord chromé

	Ø cm	↑ cm	ltr.	Farbe / Colour
00025	13	15	1	White
00026	13	15	1	Black



**Tischreste- / Besteckbehälter „BASE CHROME“**

table waste bin / cutlery bin  
 papelera de sobremesa / recipiente para cubiertos  
 poubelle de table / récipients pour couverts



mit verchromten Boden  
 with chrome bottom  
 con base cromada  
 avec base chromée

	Ø cm	↑ cm	ltr.	Farbe / Colour
00019	13	15	1,3	White
00020	13	15	1,3	Black



**Besteckständer „TRIPLE TOWER“**

cutlery basket  
 cesta para cubiertos  
 égouttoir à couverts



4-teiliges Set: 1 Gestell + 3 Köcher  
 4 pcs. set: 1 frame + 3 baskets  
 set de 4: 1 estructura + 3 cubiertos  
 set de 4: 1 structure + 3 corbeilles

	cm	↑ cm	Farbe / Colour
11466	18 x 26	43	White
11467	18 x 26	43	Black

variable Nutzungsmöglichkeiten  
 variable usage possibilities



**Besteckköcher**

cutlery basket  
 cesta para cubiertos  
 corbeille à couverts



Abtropflöcher  
 drainer  
 holes

	cm	↑ cm	Farbe / Colour
84535	12 x 12	16	White
84536	12 x 12	16	Black



**Tischkrümelentferner**

crumber  
 recogemigas  
 ramasse-miettes



matt poliert  
 satin polished finish  
 acabado mate, fácil de usar, mango hueco  
 mat satiné, manche creux, simple à utiliser

	Ø cm	↑ cm	
00058	6,5 x 2,5	22	Hohlgriff / hollow handles
00581	19,0 x 4,5	1	geschliffene Edelstahlkante flat grinded stainless steel edge



hot price

**Tischrestebehälter**  
table garbage bin  
papelera de sobremesa  
poubelle de table



	Ø cm	↑ cm	litr.
00311	14	15	1,2



hot price

**Tischrestebehälter**  
table garbage bin  
papelera de sobremesa  
poubelle de table



**Kunststoff weiß / Granit, abnehmbarer Schwingdeckel**  
white plastic, swing cover, cover removable  
plástico blanco/granito, tapa basculante desmontable  
plastique blanc/gris chiné, couvercle basculant démontable

	Ø cm	↑ cm	litr.
00031	12	18	1,4



**matt poliert**  
satin polished finish

10 cm

11921

11922

13,5 cm

**Besteckständer**  
cutlery basket  
cesta para cubiertos  
égouttoir à couverts



	Ø cm	↑ cm
11921	10	10,0
11922	12	13,5



**Tischreste- / Besteckbehälter**  
table waste bin / cutlery bin  
papelera de sobremesa / recipiente para cubiertos  
poubelle de table / récipients pour couverts



**mit verchromten Rand, inkl. herausnehmbarem Einteiler (4 Fächer)**  
with chrome plated ring, incl. divider (4 chambers)  
con anillo cromado, incl. divisor extraíble (4 compartimentos)  
avec bod chrome, incl. paroi de separation amovible (4 compartiments)

	cm	↑ cm
00016	14 x 14	16

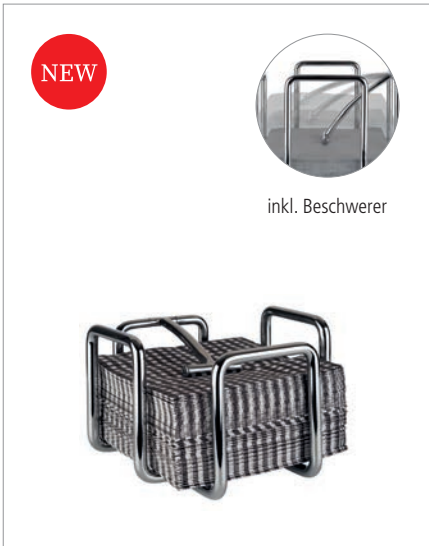

**Serviettenhalter „HERO“**

napkin holder  
servilletero  
porte-serviettes



für ca. 65 Cocktailservietten, inkl. Beschwerer  
for approx. 65 cocktail napkins, incl. weight  
para aprox. 65 servilletas cocktail, incl. barra de contrapeso  
pour environ 65 serviettes cocktail, incl. barre de contrepoids

	cm	↑ cm	
11767	14,5 x 14,5	10	für 65 Servietten / for 65 napkins para 65 servilletas / pour 65 serviettes



**Serviettenhalter „HERO“**

napkin holder  
servilletero  
porte-serviettes



für ca. 95 Servietten 1/4 Falz, inkl. Beschwerer  
for approx. 95 cocktail napkins, incl. weight  
para aprox. 95 servilletas cocktail, incl. barra de contrapeso  
pour environ 95 serviettes cocktail, incl. barre de contrepoids

	cm	↑ cm	
11768	18,5 x 18,5	14	für 95 Servietten / for 95 napkins para 95 servilletas / pour 95 serviettes



**Serviettenhalter „PROFI“**

napkin holder  
servilletero  
porte-serviettes



für 150 Servietten 1/4 Falz, inkl. Beschwerer, mit Antirutschfüßchen, absolut standfest  
for 150 napkins 1/4 fold, incl. weight, non-slip feet, very stable  
para 150 servilletas plegado 1/4, incl. barra de contrapeso, con pies antideslizantes, muy estable  
pour 150 serviettes pliage 1/4, incl. barre de contrepoids, avec pieds antidérapants, très stable

	cm	↑ cm	
11766	18,5 x 18,5	18	für 150 Servietten / for 150 napkins para 150 servilletas / pour 150 serviettes



**Serviettenhalter**

napkin holder  
servilletero  
porte-serviettes



hochglanzpoliert, für Servietten mit 1/8 Falz, Füße mit rutsch- und kratzfester Gummierung  
mirror polished finish, for napkins with 1/8 fold, rubber feet  
pulido brillante, para servilletas plegado 1/8, con revestimiento de goma  
poli miroir, pour serviettes pliage 1/8, avec revêtement en caoutchouc

	cm	↑ cm	
11720	10 x 11,5	18,5	



**Serviettenhalter „ELEMENT“**

napkin holder  
servilletero  
porte-serviettes



**aus Beton, für ca. 50 Servietten, mit möbelschonender Unterseite**  
concrete, for approx. 50 napkins, with furniture-friendly underside  
hormigón, para aprox. 50 servilletas, con base anti rayaduras  
béton, pour environ 50 serviettes, avec revêtement antirayures

	cm	↑ cm	
11781	16 x 7,5	10	für 50 Servietten / for 50 napkins para 50 servilletas / pour 50 serviettes



**Serviettenhalter „WIRE“**

napkin holder  
servilletero  
porte-serviettes



**für Servietten 1/4 Falz, inkl. Beschwerer**  
for napkins 1/4 fold, incl. weight  
para servilletas plegado 1/4, incl. barra de contrapeso  
pour serviettes pliage 1/4, incl. barre de contrepoids

	cm	↑ cm	
11763	19 x 19	6,5	für 50 Servietten / for 50 napkins para 50 servilletas / pour 50 serviettes
11765	19 x 19	19,0	für 150 Servietten / for 150 napkins para 150 servilletas / pour 150 serviettes



**Serviettenhalter „BAR“**

napkin holder  
servilletero  
porte-serviettes



**für ca. 50 Cocktailservietten, inkl. Beschwerer**  
for approx. 50 cocktail napkins, incl. weight  
para aprox. 50 servilletas cocktail, incl. barra de contrapeso  
pour environ 50 serviettes cocktail, incl. barre de contrepoids

	cm	↑ cm	
11762	14 x 14	6,5	für 50 Servietten / for 50 napkins para 50 servilletas / pour 50 serviettes



**Serviettenhalter**

napkin holder  
servilletero  
porte-serviettes



**matt poliert**  
satin polished finish  
acabado satinado  
mat satiné

	cm	↑ cm	
11730	17 x 17	5	



### Serviettenhalter

napkin holder  
servilletero  
porte-serviettes



möbelschonende Unterseite, für ca. 30 Servietten, matt poliert  
furniture-friendly underside, for approx. 30 napkins, satin polished finish  
con base anti rayaduras, para aprox. 30 servilletas, pulido mate  
avec revêtement antirayures, pour environ 30 serviettes, poli mat

	cm	↑ cm	
11780	15 x 4,5	12,5	für 30 Servietten / for 30 napkins para 30 servilletas / pour 30 serviettes



### Serviettenhalter

napkin holder  
servilletero  
porte-serviettes



möbelschonende Unterseite, für ca. 20 Servietten, matt poliert  
furniture-friendly underside, for approx. 20 napkins, satin polished finish  
con base anti rayaduras, para aprox. 20 servilletas, pulido mate  
avec revêtement antirayures, pour environ 20 serviettes, poli mat

	cm	↑ cm	
11778	17 x 3	7	für 20 Servietten / for 20 napkins para 20 servilletas / pour 20 serviettes



11631

### Holzkiste „VINTAGE“

woodbox  
caja madera  
base bois



Schubladenoptik, mit Knopf  
drawer look, with knob  
look cajón, con pomo  
look tiroir, avec bouton

	cm	↑ cm	
11631	18,5 x 18,5	11	Innenmaß: 17 x 17 cm, mit Beschriftungsfach
11633	18,5 x 18,5	11	Innenmaß: 17 x 17 cm, mit Beschriftungsfach



11633







# Buffet & Tableware Melamin

**Tablets**  
**Schalen**  
**Teller**  
**Fingerfood**  
**Eierbecher**

bandejas  
cuencos  
platos  
finger food  
hueveras

trays  
bowls  
plates  
finger food  
egg holders

plateaux  
bols  
assiettes  
finger food  
coquetiers

**NEW** HAPPY BUFFET

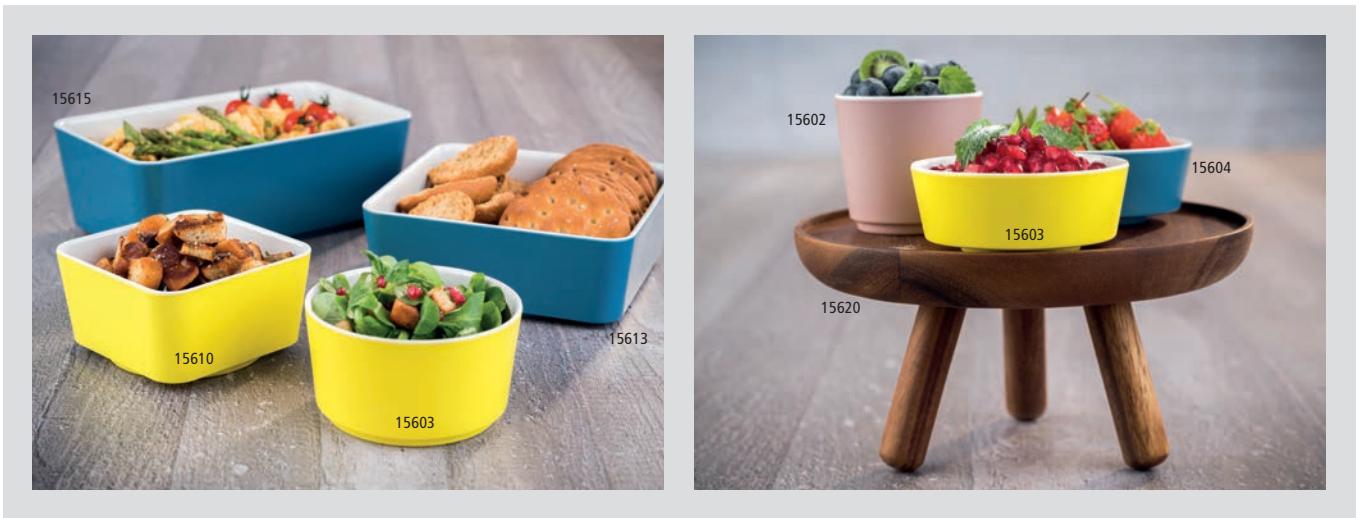

**Schale „HAPPY BUFFET“**

bowl, square  
cuenco cuadrado  
bol carré



	cm	↑ cm	ltr.	Farbe / Colour
15610	13 x 13	7	0,6	
15611	13 x 13	7	0,6	
15612	20 x 20	7	1,5	
15613	20 x 20	7	1,5	

**Deckel „UNIVERSAL“ mit Löffelaussparung / cover with notched for spoons / tapa con espacio para la cuchara / couvercle avec encoche pour la louche**

	cm	↑ cm	fits to
15345	20 x 20	1,5	15612, 15613



**GN 1/4 Schale „HAPPY BUFFET“**

GN 1/4 bowl  
GN 1/4 cuenco  
GN 1/4 bol



	cm	↑ cm	GN	ltr.	Farbe / Colour
15614	26,5 x 16,2	9	1/4	2,5	
15615	26,5 x 16,2	9	1/4	2,5	

**Deckel „UNIVERSAL“ mit Löffelaussparung / cover with notched for spoons / tapa con espacio para la cuchara / couvercle avec encoche pour la louche**

	cm	↑ cm	GN	fits to
15348	26,5 x 16,2	1,5	1/4	15614, 15615





Schale, rund „HAPPY BUFFET“

bowl, round  
cuenco, redondo  
bol rond



	Ø cm	↑ cm	litr.	Farbe / Colour
15600	6,5	6	0,15	
15601	6,5	6	0,15	
15602	6,5	6	0,15	
15603	9,0	4	0,15	
15604	9,0	4	0,15	
15605	9,0	4	0,15	
15606	13,0	7	0,60	
15607	13,0	7	0,60	
15608	20,0	7	1,50	
15609	20,0	7	1,50	



Deckel „UNIVERSAL“ mit Löffelaussparung / cover with notched for spoons / tapa con espacio para la cuchara / couvercle avec encoche pour la louche

	Ø cm	↑ cm	fits to
15341	20	1,5	15608, 15609



Buffetständer „ACACIA“

buffet stand  
soporte para buffet  
présentoir buffet



Akazienholz geölt / acacia wood oiled / madera de acacia aceitada / bois d'acacia huilé

	Ø cm	↑ cm
15620	20,0	10,5
15621	30,5	15,0
15622	30,5	20,0



Buffetständer „ACACIA“

buffet stand  
soporte para buffet  
présentoir buffet



Akazienholz geölt / acacia wood oiled / madera de acacia aceitada / bois d'acacia huilé

	cm	↑ cm	GN
15623	53 x 16,2	20	2/4

APS+

UNIVERSAL



⊕ Kompatibilität / compatibility / combinación / compatibilité

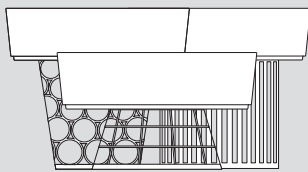

**Baskets**  
risers

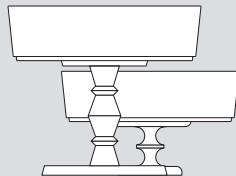

**Wood**  
risers

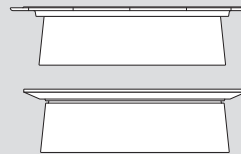

**Bakery / Wood**  
plates

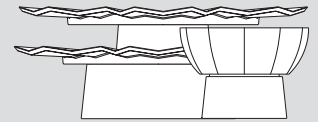

**Lotus**  
bowls / plates



weiß; innen glänzend, außen matt  
white; glossy on the inside, matt on the outside  
blanco; interior brillante, exterior mate  
blanc; intérieur brillant, extérieur mat



Holzdekor Ahorn & Farbe  
maple wood decor & colour  
textura de madera arce & color  
aspect érable & couleur

bicolor  
bicolour  
bicolor  
bicolore



Holzdekor Eiche dunkel & Farbe  
oak wood decor & colour  
textura de madera roble oscuro & color  
aspect chêne foncé & couleur

bicolor  
bicolour  
bicolor  
bicolore



Holzdekor Ahorn & cream

Holzdekor Eiche & cream

Holzdekor Ahorn & red

Holzdekor Eiche & red

Holzdekor Ahorn & green

Holzdekor Eiche & green

Holzdekor beige & cream

Holzdekor brown & cream



15116

GN 1/4 Schale „UNIVERSAL“

GN 1/4 bowl  
GN 1/4 cuenco  
GN 1/4 bol



	cm	↑ cm	GN	ltr.	Farbe / Colour
15116	26,5 x 16,2	7	1/4	1,5	White
15117	26,5 x 16,2	9	1/4	2,5	White



**Schale, quadratisch „APS+“**

bowl, square  
cuenco cuadrado  
bol carré



	cm	↑ cm	ltr.	Farbe / Colour
15110	6,5 x 6,5	6	0,15	_____
15111	9,0 x 9,0	4	0,15	_____
15112	13,0 x 13,0	7	0,60	_____



**Schale, quadratisch „APS+“**

bowl, square  
cuenco cuadrado  
bol carré



	cm	↑ cm	ltr.	Farbe / Colour
15113	20,0 x 20,0	7	1,5	_____
15114	24,0 x 24,0	9	3,5	_____
15115	26,5 x 26,5	9	4,0	_____



**Schale, rund „UNIVERSAL“**

bowl, round  
cuenco, redondo  
bol rond



	Ø cm	↑ cm	ltr.	Farbe / Colour
15100	6,5	6	0,15	_____
15101	9,0	4	0,15	_____
15102	13,0	7	0,60	_____



**Schale, rund „UNIVERSAL“**

bowl, round  
cuenco, redondo  
bol rond



	Ø cm	↑ cm	ltr.	Farbe / Colour
15103	16,0	12	1,5	_____
15104	16,0	15	2,5	_____



**Schale, rund „UNIVERSAL“**

bowl, round  
cuenco, redondo  
bol rond



	Ø cm	↑ cm	ltr.	Farbe / Colour
15105	20,0	7	1,5	_____
15106	24,0	9	2,7	_____
15108	32,5	9	4,0	_____

## Buffet & Tableware Melamin



### GN 1/4 Schale „APS+“

GN 1/4 bowl  
GN 1/4 cuenco  
GN 1/4 bol



	cm	↑ cm	GN	ltr.	Farbe / Colour
15219	26,5 x 16,2	7	1/4	1,5	
15220	26,5 x 16,2	9	1/4	2,5	
15234	26,5 x 16,2	7	1/4	1,5	
15235	26,5 x 16,2	9	1/4	2,5	



### Schale, quadratisch „APS+“

bowl, square  
bol cuadrado  
plat creux carré



	cm	↑ cm		ltr.	Farbe / Colour
15215	13,0 x 13,0	7		0,6	
15216	20,0 x 20,0	7		1,5	
15217	24,0 x 24,0	9		3,5	
15218	26,5 x 26,5	9		4,0	
15232	20,0 x 20,0	7		1,5	
15233	26,5 x 26,5	9		4,0	



### Schale, rund „APS+“

bowl, round  
cuenco, redondo  
bol rond



	Ø cm	↑ cm		ltr.	Farbe / Colour
15230	20,0	7		1,5	
15231	32,5	9		4,0	



### Schale „APS+“

bowl  
cuenco  
bol



	Ø cm	↑ cm		ltr.	Farbe / Colour
15200	6,5	6		0,15	
15201	9,0	4		0,15	



### Schale „APS+“

bowl  
cuenco  
bol



	cm	↑ cm		ltr.	Farbe / Colour
15204	6,5 x 6,5	6		0,15	
15205	9,0 x 9,0	4		0,15	

APS+

ANTI PASTI



Buffet & Tableware  
Melamin

+ Kompatibilität / compatibility / combinación / compatibilité

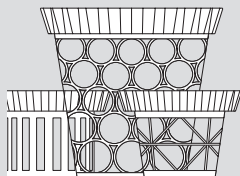

**Baskets**  
risers



**Cover**  
seal

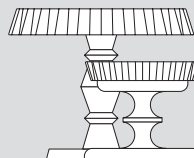

**Wood**  
risers

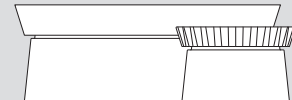

**Bowls**  
risers



Schale „APS+ PLISSEE“

bowl  
cuenco  
bol



	Ø cm	↑ cm	Farbe / Colour
15142	35	4	White



Schale „APS+“

bowl  
cuenco  
bol



	Ø cm	↑ cm	Farbe / Colour
15135	14,5	2,5	White
15136	25,0	3,5	White
15137	35,0	4,0	White



Schale Water Lily „APS+“

leaf  
fuente en forma de hoja  
plat feuille



	Ø cm	↑ cm	litr.	Farbe / Colour
15165	8,5	4	0,10	White
15166	13,0	6	0,30	White
15167	20,0	7	1,25	White

0,10 ltr.  
15165

1,25 ltr.  
15167



✚ Kompatibilität / compatibility / combinación / compatibilit 

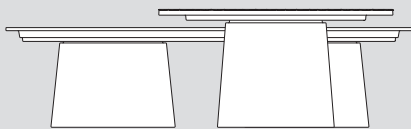

**Bowls**  
risers

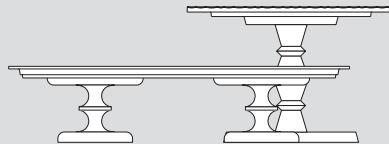

**Wood**  
risers

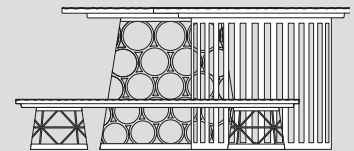

**Baskets**  
risers



GN Tablett TILES „APS+“

GN tray  
GN bandeja  
GN plateau



	cm	↑ cm	GN	Farbe / Colour
15250	26,5 x 16,2	1,5	1/4	■
15251	32,5 x 17,5	1,5	1/3	■
15253	32,5 x 26,5	1,5	1/2	■
15252	53,0 x 16,2	1,5	2/4	■

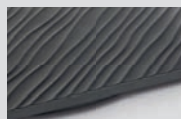





**GN Tablett TILES „APS+“**

GN tray  
GN bandeja  
GN plateau



	cm	↑ cm	GN	Farbe / Colour
15225	26,5 x 16,2	1,5	1/4	
15226	32,5 x 17,5	1,5	1/3	
15228	32,5 x 26,5	1,5	1/2	
15227	53,0 x 16,2	1,5	2/4	



**Korb / Ständer „BASKET“**

basket / riser  
cesta / soporte  
corbeille / support



	Ø cm	↑ cm	Farbe / Colour
15320	10,5 / 8	8	
15324	10,5 / 8	8	
15322	10,5 / 8	8	

+ Kompatibilität / compatibility / combinación / compatibilité



Universal  
bowls

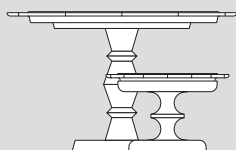

Tiles  
plates

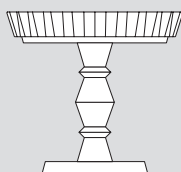

Antipasti  
flat bowls

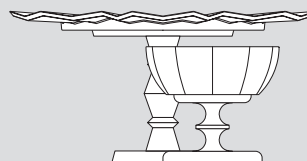

Lotus  
plates / bowls

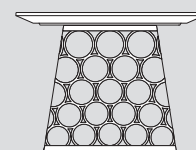

Baskets  
risers



15300

Tablett WOOD „APS+“

tray  
bandeja  
plateau



	Ø cm	↑ cm	Farbe / Colour
15300	30,0	2	
15302	38,5	2	



15303

Tablett WOOD „APS+“

tray  
bandeja  
plateau



	Ø cm	↑ cm	Farbe / Colour
15301	30,0	2	
15303	38,5	2	



15310

Ständer WOOD „APS+“

stand  
soporte  
support



	Ø cm	↑ cm	Farbe / Colour
15310	15 / 11,5	10,5	
15311	15 / 11,5	10,5	



15313

Ständer WOOD „APS+“

stand  
soporte  
support



	Ø cm	↑ cm	Farbe / Colour
15312	21 / 15	20	
15313	21 / 15	20	



**Frischhalte-Haube „APS+“**

cover  
campana  
cloche bombée



glasklar, Griff verchromt, schwere, stabile Ausführung

transparent, chrome knob, heavy stable quality  
transparente, asa cromada, alta estabilidad  
transparente, anse chromée, très stable

	Ø cm	↑ cm	✱ mm	fits to
15350	16,5	10	3	15130
15351	20,5	10	3	15141, 15136, 15271, 15131



**Frischhalte-Haube**

cover  
campana  
cloche



	Ø cm	↑ cm	fits to
06512	30	11,5	15142, 15137, 15272, 15132
06517	33	12,5	15133, 15302, 15303



**Rolltophaube**

rolltop cover  
campana abatible  
cloche basculante



glasklarer Kunststoff, leichtgängig auf- und zuklappen 90°

solid quality, to be opened 90°  
plástico transparente de alta calidad, apertura a 90°  
plastique transparent résistant, ouverture 90°

	Ø cm	↑ cm	fits to
18388	38	20	15302, 15303



**Haube**

cover  
campana  
cloche



	Ø cm	↑ cm	fits to
06519 <small>new</small>	21	17	15312, 15313
06520	30	22	15300, 15301
06521 <small>new</small>	36	27	15302, 15303

# ASIA+



Nahezu alle ASIA+ Produkte verfügen über ein System von Ringen und Radien und können dadurch stand- und rutschfest miteinander kombiniert werden. So können beispielsweise alle Schalen auch als Riser / Aufsteller für unterschiedlichste weitere ASIA+ Produkte verwendet werden.

Nearly all ASIA+ products feature a system of rings and radii that allow them to be combined with each other in a stable manner. For example, all bowls can be used as risers for a wide range of other ASIA+ products. The same applies to the baskets.

Casi todos los productos de ASIA+ disponen de un sistema de anillos y radios que permiten su combinación entre sí con una estabilidad perfecta. Así por ejemplo, todos los cuencos se pueden utilizar también como pedestales para los productos más diversos de ASIA+. Y lo mismo ocurre con las cestas.

Presque tous les produits ASIA+ sont munis d'un système d'anneaux et de rayons, ce qui permet de les combiner entre eux de façon stable. Ainsi, tous les bols et saladiers servent aussi de rehausseurs pour les produits ASIA+ les plus divers. Il en va de même des corbeilles.



Tablett tray

Schale bowl



15523 / 15525  
Tablett / tray

15524 / 15526  
Zwischenplatte



**Tablett „ASIA PLUS“**

tray  
bandeja  
plateau



	Ø cm	↑ cm	Farbe / Colour
15530	30,0	3	
15531	38,0	3	
15532	48,5	3	
15533	30,0	3	
15534	38,0	3	
15535	48,5	3	



**Tablett / Platte „ASIA PLUS“**

tray  
bandeja  
plateau



	Ø cm	↑ cm	
15523	38,0	2,5	einfach gefälzt / single seamed pliegue sencillo / plié une seule fois
15525	48,5	2,5	einfach gefälzt / single seamed pliegue sencillo / plié une seule fois



**Zwischenplatte „ASIA PLUS“**

intermediate plate  
bandeja intermedia  
plateau intermédiaire



	Ø cm	↑ cm	
15524	38,0	2,5	doppelt gefälzt / double seamed pliegue doble / plié en double
15526	48,5	2,5	doppelt gefälzt / double seamed pliegue doble / plié en double

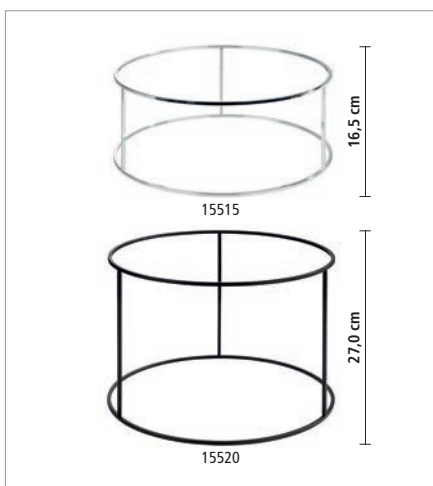

**Buffetständer „ASIA PLUS“**

buffet stand  
soporte para buffet  
présentoir buffet



	Ø cm	↑ cm	Farbe / Colour
15515	38,0	16,5	
15516	38,0	27,0	
15517	48,5	16,5	
15518	48,5	27,0	
15519	38,0	16,5	
15520	38,0	27,0	
15521	48,5	16,5	
15522	48,5	27,0	

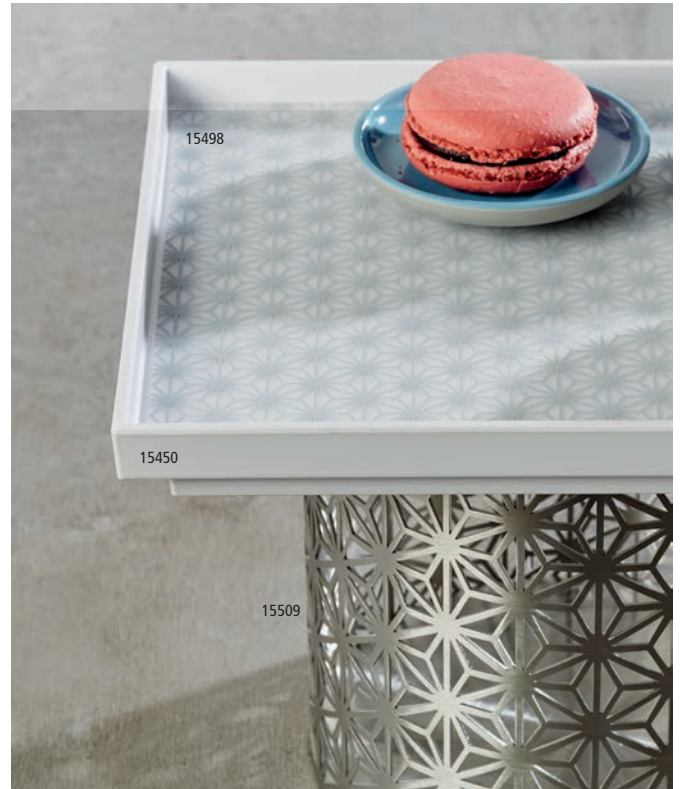

**GN Tablett „ASIA PLUS“**

GN tray  
GN bandeja  
GN plateau



	cm	↑ cm	GN	Farbe / Colour
15449	53,0 x 32,5	3	1/1	White
15450	32,5 x 26,5	3	1/2	White
15451	32,5 x 17,6	3	1/3	White
15452	26,5 x 16,2	3	1/4	White
15453	35,4 x 32,5	3	2/3	White
15454	53,0 x 16,2	3	2/4	White
15455	53,0 x 32,5	3	1/1	Black/Red
15456	32,5 x 26,5	3	1/2	Black/Red
15457	32,5 x 17,6	3	1/3	Black/Red
15458	26,5 x 16,2	3	1/4	Black/Red
15459	35,4 x 32,5	3	2/3	Black/Red
15460	53,0 x 16,2	3	2/4	Black/Red

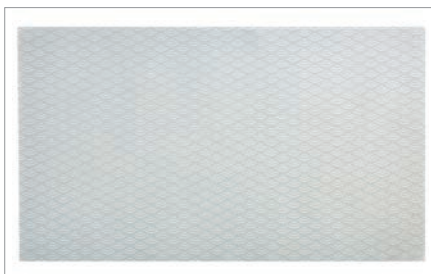

**Antirutschmatte „ASIA PLUS“**

non slip mat  
esterilla antideslizante  
tapis antidérapant



	cm	fits to
15497	51 x 31,0	15449, 15455
15499	31 x 25,5	15450, 15456



**Antirutschmatte „ASIA PLUS“**

non slip mat  
esterilla antideslizante  
tapis antidérapant



	cm	fits to
15498	51 x 31,0	15449, 15455
15500	31 x 25,5	15450, 15456

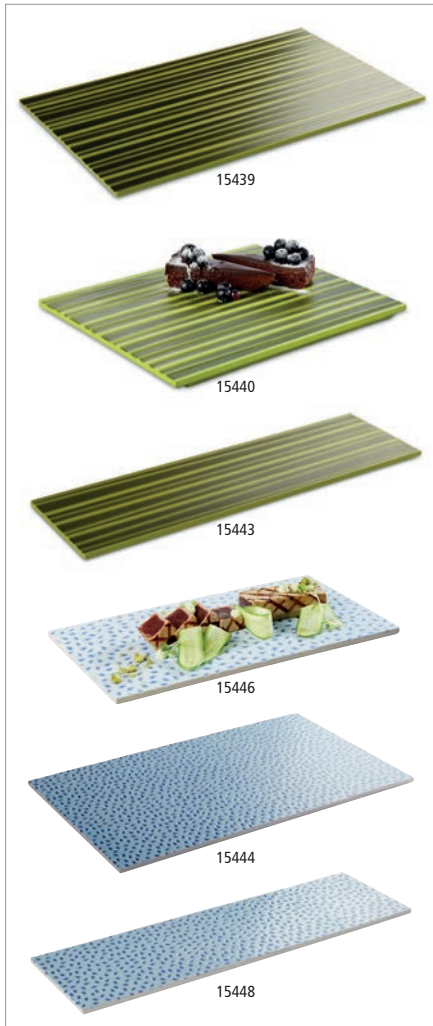

GN Tablett „ASIA PLUS“

GN tray  
GN bandeja  
GN plateau



	cm	↑ cm	GN	Farbe / Colour
15439	53,0 x 32,5	1,5	1/1	
15440	32,5 x 26,5	1,5	1/2	
15441	32,5 x 17,6	1,5	1/3	
15442	26,5 x 16,2	1,5	1/4	
15443	53,0 x 16,2	1,5	2/4	
15444	53,0 x 32,5	1,5	1/1	
15445	32,5 x 26,5	1,5	1/2	
15446	32,5 x 17,6	1,5	1/3	
15447	26,5 x 16,2	1,5	1/4	
15448	53,0 x 16,2	1,5	2/4	

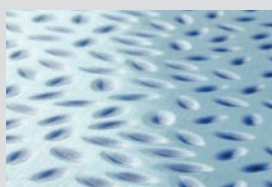
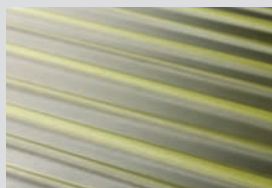

GN 1/1	GN 1/2	GN 1/4	GN 2/4
	GN 1/2	GN 1/4	
GN 1/3	GN 1/3	GN 1/3	



Schale „ASIA PLUS“

bowl  
cuenco  
bol



	Ø cm	↑ cm	ltr.	Farbe / Colour
15400	7,5	3,5	0,06	■ ■
15401	9,5	4,5	0,13	■ ■
15402	13,0	5,5	0,35	■ ■
15403	16,0	7,0	0,60	■ ■
15404	20,0	8,0	1,10	■ ■
15405	24,0	9,5	2,20	■ ■
15406	26,5	11,0	3,00	■ ■
15407	32,5	12,5	5,40	■ ■
15408	7,5	3,5	0,06	■ ■
15409	9,5	4,5	0,13	■ ■
15410	13,0	5,5	0,35	■ ■
15411	16,0	7,0	0,60	■ ■
15412	20,0	8,0	1,10	■ ■
15413	24,0	9,5	2,20	■ ■
15414	26,5	11,0	3,00	■ ■
15415	32,5	12,5	5,40	■ ■
15416	7,5	3,5	0,06	■ ■
15417	9,5	4,5	0,13	■ ■
15418	13,0	5,5	0,35	■ ■
15419	16,0	7,0	0,60	■ ■
15420	20,0	8,0	1,10	■ ■
15421	24,0	9,5	2,20	■ ■
15422	26,5	11,0	3,00	■ ■
15423	32,5	12,5	5,40	■ ■



Deckel „UNIVERSAL“ mit Löffelaussparung

cover with notched for spoons  
tapa con espacio para la cuchara  
couvercle avec encoche pour la louche



	Ø cm	↑ cm	fits to
15340	16,0	1,5	15403, 15411, 15419
15341	20,0	1,5	15404, 15412, 15420
15342	24,0	1,5	15405, 15413, 15421
15343	26,5	1,5	15406, 15414, 15422
15344	32,5	1,5	15407, 15415, 15423





Teller „ASIA PLUS“  
plate  
plato  
assiette



	Ø cm	↑ cm	Farbe / Colour
15424	11,0	2	
15425	16,0	2	
15426	19,5	2	
15427	24,0	2	
15428	28,0	2	

	Ø cm	↑ cm	Farbe / Colour
15429	11,0	2	
15430	16,0	2	
15431	19,5	2	
15432	24,0	2	
15433	28,0	2	

	Ø cm	↑ cm	Farbe / Colour
15434	11,0	2	
15435	16,0	2	
15436	19,5	2	
15437	24,0	2	
15438	28,0	2	



Buffet & Tableware Melamin





Bento Box „ASIA PLUS“



	Ø cm	↑ cm	ltr.	Farbe / Colour
15461	7,5	3,0	0,04	White
15462	7,5	6,5	0,13	White



	Ø cm	↑ cm	ltr.	Farbe / Colour
15467	7,5	3,0	0,04	Black/Red
15468	7,5	6,5	0,13	Black/Red



	cm	↑ cm	ltr.	Farbe / Colour
15473	7,5 x 7,5	3,0	0,05	White
15474	7,5 x 7,5	6,5	0,16	White
15479	15,5 x 15,5	3,0	0,19	White
15480	15,5 x 15,5	6,5	0,85	White



	cm	↑ cm	ltr.	Farbe / Colour
15485	7,5 x 7,5	3,0	0,05	Black/Red
15486	7,5 x 7,5	6,5	0,16	Black/Red
15491	15,5 x 15,5	3,0	0,19	Black/Red
15492	15,5 x 15,5	6,5	0,85	Black/Red



	cm	↑ cm	ltr.	Farbe / Colour
15475	15,5 x 7,5	3,0	0,10	White
15477	15,5 x 9,5	3,0	0,15	White
15476	15,5 x 7,5	6,5	0,40	White
15478	15,5 x 9,5	6,5	0,50	White
15483	25,0 x 15,5	3,0	0,30	White
15484	25,0 x 15,5	6,5	1,40	White



	cm	↑ cm	ltr.	Farbe / Colour
15487	15,5 x 7,5	3,0	0,10	Black/Red
15488	15,5 x 7,5	6,5	0,40	Black/Red
15489	15,5 x 9,5	3,0	0,15	Black/Red
15490	15,5 x 9,5	6,5	0,50	Black/Red
15495	25,0 x 15,5	3,0	0,30	Black/Red
15496	25,0 x 15,5	6,5	1,40	Black/Red



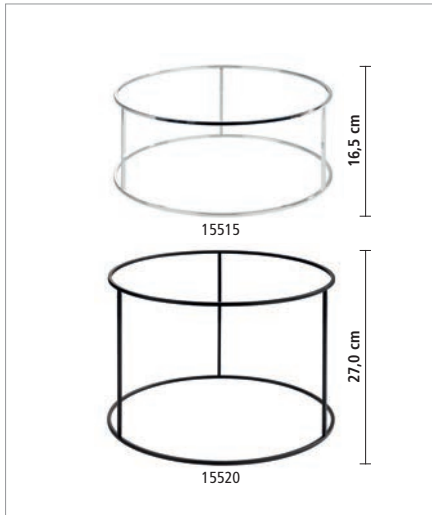

**Buffetständer „ASIA PLUS“**

buffet stand  
soporte para buffet  
présentoir buffet



	Ø cm	↑ cm	Farbe / Colour
15515	38,0	16,5	■
15516	38,0	27,0	■
15517	48,5	16,5	■
15518	48,5	27,0	■
15519	38,0	16,5	■
15520	38,0	27,0	■
15521	48,5	16,5	■
15522	48,5	27,0	■



**GN Buffetständer „ASIA PLUS“**

GN buffet stand  
GN soporte para buffet  
GN présentoir buffet



	cm	GN	Farbe / Colour
15501	53,0 x 32,5 / 53,0 x 16,2	1/1 / 2/4	■
15502	32,5 x 26,5 / 26,5 x 16,2	1/2 / 1/4	■
15503	32,5 x 17,5 / 35,4 x 32,5	1/3 / 2/3	■
15504	53,0 x 32,5 / 53,0 x 16,2	1/1 / 2/4	■
15505	32,5 x 26,5 / 26,5 x 16,2	1/2 / 1/4	■
15506	32,5 x 17,5 / 35,4 x 32,5	1/3 / 2/3	■

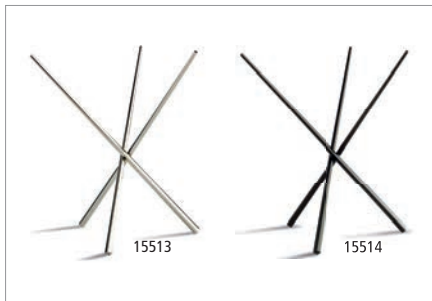

**Buffetständer „ASIA PLUS“**

buffet stand  
soporte para buffet  
présentoir buffet



	Ø cm	↑ cm	Farbe / Colour
15513	20,5 / 16,5	20	stainless steel
15514	20,5 / 16,5	20	■



**Buffetständer / -korb „ASIA PLUS“**

buffet stand / basket  
soporte para buffet / cestas  
présentoir buffet / corbeilles



	Ø cm	↑ cm	Farbe / Colour
15507	15	10,5	■
15510	15	10,5	■
	Ø cm	↑ cm	Farbe / Colour
15508	21	10,5	■
15511	21	10,5	■
	Ø cm	↑ cm	Farbe / Colour
15509	21	20	■
15512	21	20	■

**NEW ACACIA**

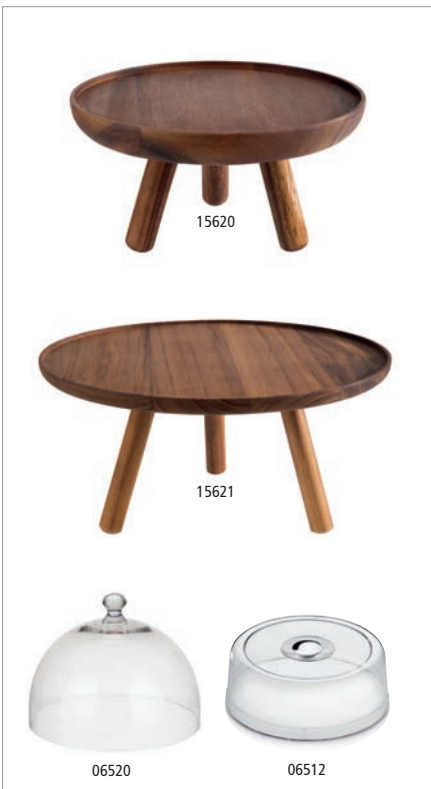

**Buffetständer „ACACIA“**

buffet stand  
soporte para buffet  
présentoir buffet



Akazienholz geölt / acacia wood oiled / mader de acacia aceitada / bois d'acacia huilé

	Ø cm	↑ cm
15620	20,0	10,5
15621	30,5	15,0
15622	30,5	20,0

**Frischhalte- Haube / cover / campana / cloche**



	Ø cm	↑ cm	fits to
06520	30	22	15621, 15622

**Frischhalte- Haube / cover / campana / cloche**



	Ø cm	↑ cm	fits to
06512	30	11,5	15621, 15622

**Buffetständer „ACACIA“**

buffet stand  
soporte para buffet  
présentoir buffet



Akazienholz geölt / acacia wood oiled / mader de acacia aceitada / bois d'acacia huilé

	cm	↑ cm	GN
15623	53 x 16,2	20	2/4

**GN Abdeckhaube / GN cover / GN cubierta/ GN cloche**



	cm	↑ cm	✱ mm	GN
11044	53 x 16,2	10,5	3	2/4



# POKE BOWL - *super trendy*



Buffet & Tableware Melamin

Die Farben und Formen von Lebensmittel und die Art, wie sie in den BOWLS angerichtet werden, regen unsere Sinne und unseren Appetit an. Das ist auch schon das Geheimnis der Bowl - Gerichte, die zurzeit in großer Vielfalt, mit viel Fantasie und Liebe zum Detail zubereitet werden.

The colours and shapes of food and the way they are arranged in the BOWLS stimulate our senses and our appetite. This is the secret of the bowl dishes, which are currently prepared in great variety, with a lot of imagination and attention to detail.

Los colores y las formas de los alimentos y la manera de presentación en los CUENCOS estimulan nuestros sentidos y nuestro apetito. Ese es el secreto de los platos en cuenco, que actualmente se preparan en gran variedad, con mucha imaginación y atención a los detalles.

Les couleurs et les formes des aliments et la façon dont ils sont disposés dans les BOLS stimulent nos sens et notre appétit. C'est aussi le secret des plats du bol, qui sont actuellement préparés dans une grande variété, avec beaucoup d'imagination et d'attention au détail.



**Schale „POKE BOWL“**  
bowl  
cuenco  
bol

MELAMINE MF icons

	Ø cm	↑ cm	ltr.	Farbe / Colour
85003	20	7	0,9	white
85005	20	7	0,9	coconut



**Schale „POKE BOWL“**  
bowl  
cuenco  
bol

MELAMINE MF icons

	Ø cm	↑ cm	ltr.	Farbe / Colour
85000	16	9	1,1	white
85002	16	9	1,1	coconut



**Schale „POKE BOWL“**  
bowl  
cuenco  
bol

MELAMINE MF icons

	Ø cm	↑ cm	ltr.	Farbe / Colour
85006	20	9	1,6	white
85008	20	9	1,6	coconut

# BLUE OCEAN



Da geht die Sonne auf!  
Maritime Aquatöne,  
Farbverläufe und klassisches  
Blau-Weiß erinnert an eine  
griechische Taverne in der  
Ägäis.

The sun is rising!  
Maritime aqua tones,  
gradients and classic blue  
and white reminiscent of  
a Greek tavern in the  
Aegean Sea.

¡Está saliendo el sol! Los tonos marinos, los degradados de color, el clásico azul y blanco recuerdan a una taberna griega en el mar Egeo.

Le soleil se lève! Les tons maritimes, les dégradés de couleurs, le bleu et le blanc classiques, tout rappellent une taverne grecque de la mer Égée.

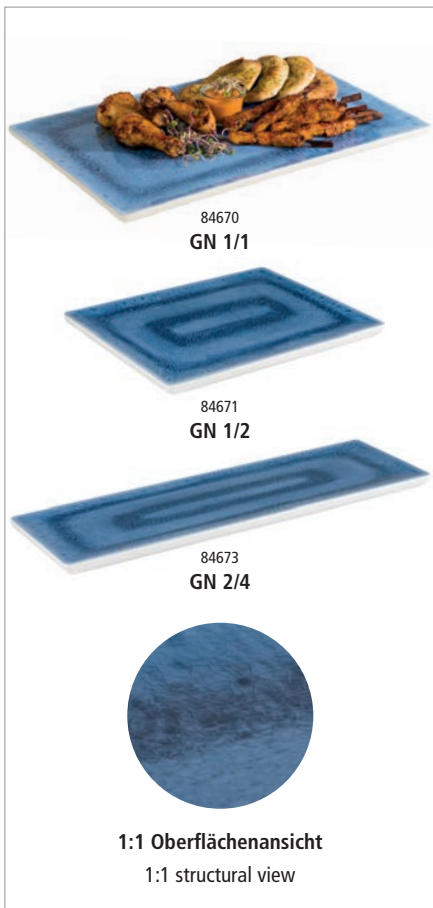

## GN Tablett „BLUE OCEAN“

GN tray  
GN bandeja  
GN plateau



	cm	↑ cm	GN
84670	53,0 x 32,5	2	1/1
84671	32,5 x 26,5	2	1/2
84672	32,5 x 17,6	2	1/3
84673	53,0 x 16,2	2	2/4

GN 1/1	GN 1/2	GN 2/4	GN 1/3
	GN 1/2		GN 1/3
			GN 1/3

**NEW**  
mit Antirutsch-  
füßchen  
with non-slip feet







Tablett „BLUE OCEAN“

tray  
bandeja  
plateau



	cm	↑ cm
84676	48 x 35,5	3

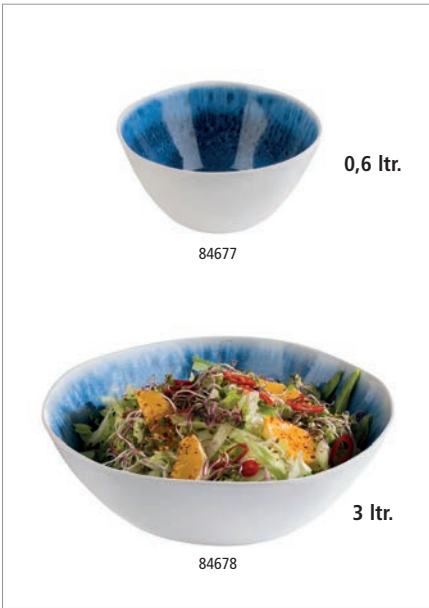

Schale „BLUE OCEAN“

bowl  
cuenco  
bol



	Ø cm	↑ cm	ltr.
84677	15	7,5	0,6

	Ø cm	↑ cm	ltr.
84678	30,5	9	3



Teller „BLUE OCEAN“

plate  
plato  
assiette



	Ø cm	↑ cm
84674	21,5	2
84675	26,5	2

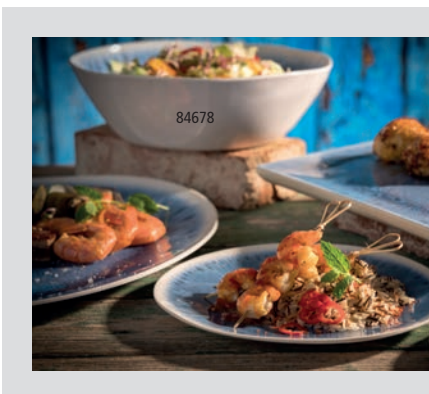

# ARABESQUE



Beim Anblick der mediterranen Melamin Serie ARABESQUE bekommt man direkt Lust auf eine Tapas-Party. Mit seinem spanischen Charme und den wundervoll ausgearbeiteten Details holen Sie sich ein Stück Spanien auf Ihr Buffet.

When looking at the Mediterranean melamine series ARABESQUE, the longing for a tapas party resurfaces. With its Spanish charm and the beautifully crafted details, you get a slice of Spain on your buffet.

Al ver la serie mediterránea de melamina ARABESQUE, se obtiene un dicho antojo por una fiesta de tapas. Con su encanto español y los detalles bellamente elaborados, obtenga una rebanada de España en su buffet.

En regardant la série de mélamine méditerranéenne ARABESQUE, vous obtenez envie de préparer une fête de tapas. Avec son charme espagnol et les détails joliment ouverts, vous aurez une tranche d'Espagne sur votre buffet.



## GN Tablett „ARABESQUE“

GN tray  
GN bandeja  
GN plateau



	cm	↑ cm	GN
84680	53,0 x 32,5	2	1/1
84681	32,5 x 26,5	2	1/2
84682	32,5 x 17,6	2	1/3
84683	53,0 x 16,2	2	2/4

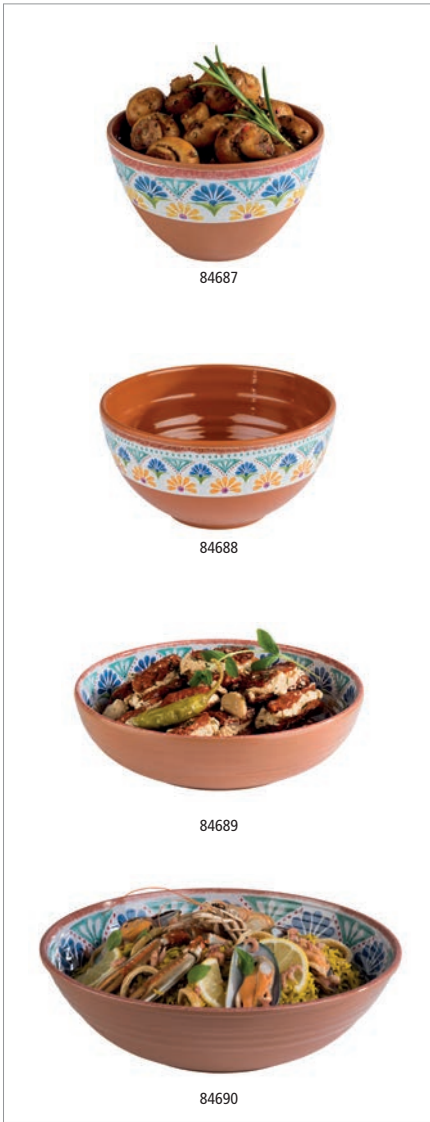

Schale „ARABESQUE“

bowl  
cuenco  
bol



	Ø cm	↑ cm	litr.
84687	10,0	6,0	0,2
84688	15,5	8,0	0,8
.....			
	Ø cm	↑ cm	litr.
84689	20,5	5,5	1,1
84690	31,0	9,0	3,0



1:1 Oberflächenansicht

1:1 structural view



Teller „ARABESQUE“

plate  
plato  
assiette



	cm	↑ cm
84686	38 x 15,5	2



Teller „ARABESQUE“

plate  
plato  
assiette



	Ø cm	↑ cm
84684	21,5	2
84685	26,5	2



# BAMBOO



Teller „BAMBOO“  
plate  
plato  
assiette



	cm	↑ cm
84809	24 x 17	3,5



Schale „BAMBOO“  
bowl  
cuenco  
bol



	cm	↑ cm	ltr.
84815	10,5 x 10,0	3,0	0,03
84816	17,5 x 15,5	5,5	0,2



Schale „BAMBOO“  
bowl  
cuenco  
bol



	Ø cm	↑ cm	ltr.
84819	30,5	8,5	2



Schale „BAMBOO“  
bowl  
cuenco  
bol



	cm	↑ cm	ltr.
84817	18,0 x 17,5	5,5	0,3
84818	23,0 x 22,0	7,0	0,7



Tablett „BAMBOO“

tray  
bandeja  
plateau



	cm	↑ cm
84803	10,0 x 10,0	2,0
84804	14,5 x 14,5	2,5
84805	31,0 x 10,5	2,0
84806	21,0 x 13,0	3,0
84807	24,5 x 15,5	3,0
84808	34,5 x 21,5	3,0



GN Tablett „BAMBOO“

tray  
bandeja  
plateau



	cm	↑ cm	GN
84800	53,0 x 32,5	2	1 / 1
84801	32,5 x 26,5	2	1/2
84802	32,5 x 17,6	2	1/3



Tablett „BAMBOO“

tray  
bandeja  
plateau



	cm	↑ cm
84811	24,5 x 15	3,5
84812	32,5 x 19	4,5



Tablett „BAMBOO“

tray  
bandeja  
plateau



	cm	↑ cm
84813	40 x 25,5	3,0
84814	53 x 34,0	3,5



Tablett „BAMBOO“

tray  
bandeja  
plateau



	cm	↑ cm
84810	34 x 13	3



**NEW** **LOOPS**

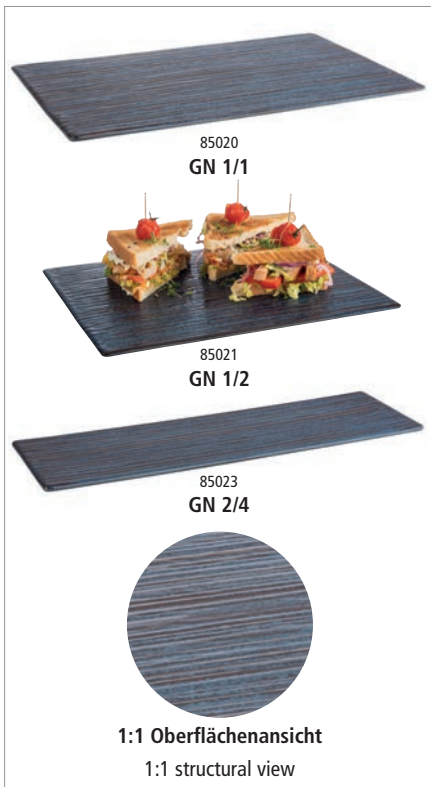

**GN Tablett „LOOPS“**

GN tray  
GN bandeja  
GN plateau



	cm	↑ cm	GN	Farbe / Colour
85020	53,0 x 32,5	1,5	1/1	
85021	32,5 x 26,5	1,5	1/2	
85022	32,5 x 17,6	1,5	1/3	
85023	53,0 x 16,2	1,5	2/4	



**Tablett/Sushi board „LOOPS“**

tray  
bandeja  
plateau



	cm	↑ cm
85025	23,5 x 13,5	1,5



**Teller „LOOPS“**

plate  
plato  
assiette



	Ø cm	↑ cm
85027	22	2
85028	27	2



Schale „LOOPS“

bowl  
cuenco  
bol



	cm	↑ cm
85024	34 x 15,5	4



Schale „LOOPS“

bowl  
cuenco  
bol



	Ø cm	↑ cm
85026	18	3



Schale „LOOPS“

bowl  
cuenco  
bol



	Ø cm	↑ cm	ltr.
85029	20,5	6,5	0,8
85030	31,0	8,0	2,0



Tablett „LOOPS“

tray  
bandeja  
plateau



	Ø cm	↑ cm
85031	32,0	3,5
85032	40,5	5,0



Torten- / Konditorplatte „LOOPS“

cake stand  
soporte para pastel  
présentoir à gâteaux



	Ø cm	↑ cm	passende Haube / suitable cover / campana adecuada / cloche appropriée
85033	21,5	2,5	06519 <b>NEW</b>
85034	30,5	3,5	06520, 06512, 06510
85035	37,5	4,0	06521 <b>NEW</b>

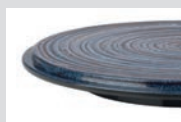

# HANOI



Die ansteigenden Schalenformen erzeugen eine asiatische Markt Optik und verleihen Ihrem Buffet durch die gewobene Oberflächenstruktur eine natürliche Authentizität.

The rising bowl forms create an Asian market look and give your buffet a natural authenticity through the woven surface structure.

La forma creciente de los cuencos crea un look de un mercado asiático y le dá a su buffet una autenticidad natural gracias a la estructura de la superficie tejida.

La forme croissante de bols crée un aspect visuel d'une marché asiatique et donne à votre buffet une authenticité naturelle à travers la structure de surface tissée.



## Schale / Teller „HANOI“

bowl / plate  
cuenco / plato  
bol / assiette



	∅ cm	↑ cm
84725	25,5	3,0 / 6,5
84726	30,0	3,5 / 7,5
84727	35,5	4,0 / 9,0







# AQUARIS

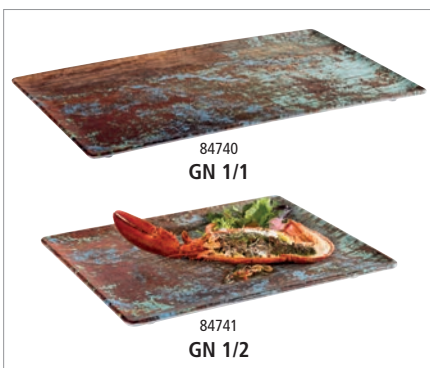

## GN Tablett „AQUARIS“

GN tray  
GN bandeja  
GN plateau



	cm	↑ cm	GN	Farbe / Colour
84740	53,0 x 32,5	2	1/1	
84741	32,5 x 26,5	2	1/2	
84742	32,5 x 17,6	2	1/3	
84743	53,0 x 16,2	2	2/4	

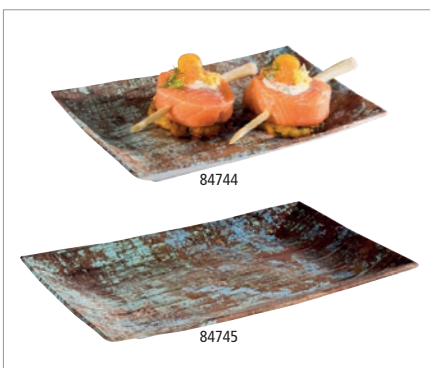

## Tablett „AQUARIS“

tray  
bandeja  
plateau



	cm	↑ cm	Farbe / Colour
84744	21,0 x 13	3	
84745	34,5 x 22	3	



## Teller „AQUARIS“

plate  
plato  
assiette



	Ø cm	↑ cm	Farbe / Colour
84746	26	3,5	
84747	35	3,0	

	cm	↑ cm	Farbe / Colour
84748	24,0 x 17	3,5	
84749	40,5 x 30	4,0	



Schale „COCONUT“

bowl  
cuenco  
bol



	∅ cm	↑ cm	ltr.	Farbe / Colour
84990	14	6,5	0,5	white/coconut
84991	24	9,5	2,2	white/coconut



1:1 Oberflächenansicht  
1:1 structural view



Schale „ELEMENT LOOK“

bowl  
cuenco  
bol



	∅ cm	↑ cm	ltr.
84835	21,5	5,5 / 9,5	0,7
84836	26,0	7,0 / 12,5	1,45
84837	30,0	8,5 / 14,5	2,3



1,45 ltr.

84836



mit Antirutschfüßchen  
with non-slip feet  
con pies antideslizantes  
avec pieds antidérapants



**GN Tablett „IRON“**  
GN tray  
GN bandeja  
GN plateau

MF MELAMINE

	cm	↑ cm	GN
84884	32,5 x 26,5	2	1/2
84885	26,5 x 16,2	2	1/4
84886	53,0 x 16,2	2	2/4



**Schale „IRON“**  
GN bowl  
GN cuenco  
GN bol

MF MELAMINE

	cm	↑ cm	GN	litr.
84880	32,5 x 26,5	8,5	1/2	3,5
84881	26,5 x 16,2	8,5	1/4	1,4
84882	53,0 x 16,2	8,5	2/4	3,2
84883	25,0 x 25,0	10,0	-	2,8





84511

Teller „STONE ART“  
plate  
plato  
assiette



	Ø cm	↑ cm
84510	19	2
84511	25	2
84512	30	2



84509

Teller „STONE ART“  
plate  
plato  
assiette



	Ø cm	↑ cm	ltr.
84509	15,5	2,5	0,15
84514	20,0	4,5	0,60



Teller „STONE ART“  
plate  
plato  
assiette



	Ø cm	↑ cm
84515	24,5	3,5



Teller „STONE ART“  
plate  
plato  
assiette



	cm	↑ cm
84517	33 x 32,5	3



Schale „STONE ART“

bowl  
cuenco  
bol



	Ø cm	↑ cm	ltr.
84523	8	3	0,07



Schale „STONE ART“

bowl  
cuenco  
bol



	Ø cm	↑ cm	ltr.
84524	12	6	0,3



Schale „STONE ART“

bowl  
cuenco  
bol



	Ø cm	↑ cm	ltr.
84525	15	7,5	0,6



Schale „STONE ART“

bowl  
cuenco  
bol



	cm	↑ cm	ltr.
84526	23 x 19	6,5	0,6



Schale „STONE ART“

bowl  
cuenco  
bol



	cm	↑ cm	ltr.
84528	28,5 x 21	7,5	1,2



Schale „STONE ART“

bowl  
cuenco  
bol



	cm	↑ cm	ltr.
84529	19 x 19	6,0	0,5
84530	24 x 24	6,5	1,1

## Buffet & Tableware Melamin



### GN Tablett „STONE ART“

GN tray  
GN bandeja  
GN plateau



	cm	↑ cm	GN
84519	53,0 x 32,5	1,5	1/1
84520	32,5 x 26,5	1,5	1/2
84522	53,0 x 16,2	1,5	2/4
84521	32,5 x 17,6	1,5	1/3



mit Antirutschfüßchen  
with non-slip feet  
con pies antideslizantes  
avec pieds antidérapants



### GN Abdeckhaube

GN cover  
GN cubierta  
GN cloche



passend für GN Tablett, glasklarer Kunststoff, nahezu unzerbrechlich  
suitable for GN trays, clear plastic, nearly unbreakable  
apto para bandejas GN, plástico transparente, muy resistente a la rotura  
pour bacs et plateaux GN, plastique transparent, très résistant à la casse

	cm	↑ cm	∩ mm	GN
11043	32,5 x 17,6	10,5	3	1/3
11044	53,0 x 16,2	10,5	3	2/4

	cm	↑ cm	∩ mm	GN
11041	32,5 x 26,5	9,5	3	1/2
11042	53,0 x 32,5	9,5	3	1/1

# AIKO



## Schale „AIKO“

bowl  
cuenco  
bol



### Steinoptik

appearance stoneware  
su aspecto recuerda al gres  
l'aspect de la mélamine rapelle le grès

	cm	↑ cm	ltr.	Farbe / Colour
84327	26,5 x 19,5	6	0,9	■



84331

## Schale „AIKO“

bowl  
cuenco  
bol



### Steinoptik

appearance stoneware  
su aspecto recuerda al gres  
l'aspect de la mélamine rapelle le grès

	Ø cm	↑ cm	ltr.	Farbe / Colour
84329	8,0	4	0,07	■
84331	11,5	6	0,20	■



84334

84337

## Schale „AIKO“

bowl  
cuenco  
bol



### Steinoptik

appearance stoneware  
su aspecto recuerda al gres  
l'aspect de la mélamine rapelle le grès

	Ø cm	↑ cm	ltr.	Farbe / Colour
84334	16,0	7	0,6	■
84336	20,5	8	1,2	■
	Ø cm	↑ cm	ltr.	Farbe / Colour
84335	16,0	7	0,6	■
84337	20,5	8	1,2	■



Betonoberflächen auf dem Buffet für den Kontakt mit Lebensmitteln? ELEMENT macht es möglich. Bestens geeignet im modernen und urbanen Ausstattungsumfeld.

Concrete surfaces on the buffet for food contact? ELEMENT makes it possible. Ideally suited for modern and urban environments.

¿Superficies de hormigón en el buffet y tener contacto con alimentos? ELEMENT lo hace posible. Ideal para ambientes modernos y urbanos.

Des surfaces en béton sur le buffet et destinées au contact alimentaire? ELEMENT le rend possible. Idéal pour les environnements modernes et urbains.



Schale „ELEMENT“

bowl  
cuenco  
bol



	cm	↑ cm	ltr.
84825	∅ 8,0	2,0	0,01
84826	10,5 x 10,0	3,0	0,02
84820	9,0 x 7,0	3,0	0,03
84821	10,5 x 10,5	3,0	0,04
84827	17,5 x 15,5	5,5	0,18



Tablett „ELEMENT“

tray  
bandeja  
plateau



	cm	↑ cm
84822	20 x 9,5	2,5



Tablett „ELEMENT“

tray  
bandeja  
plateau



	cm	↑ cm
84824	31 x 10,5	1,5





Tablett „ELEMENT“

tray  
bandeja  
plateau



	cm	↑ cm
84823	22,5 x 15	3



Schale „ELEMENT“

bowl  
cuenco  
bol



	Ø cm	↑ cm	ltr.
84828	16	7	0,5
84829	28	12	3,0



Schale „ELEMENT“

bowl  
cuenco  
bol



	cm	↑ cm	ltr.
84830	19 x 19	9	1,5
84831	25 x 25	12	3,8



GN Tablett „ELEMENT“

GN tray  
GN bandeja  
GN plateau



	cm	↑ cm	GN
84400	53,0 x 32,5	3,5	1/1
84401	32,5 x 26,5	3,5	1/2
84402	32,5 x 17,5	3,5	1/3
84403	26,5 x 16,2	3,5	1/4
84404	53,0 x 16,2	3,5	2/4

# CROCKER



Servier- und Buffetartikel in Tonoptik, brauner Rand. Die Oberfläche ist innen und außen fein-matt, fühlt sich an wie Ton.

Serving and buffet items, an imitation of clay, with a brown border. The surface is inside and outside fine-matt. Feels like real clay.

Artículos de servicio y buffet, imitación barro y con borde marrón. La superficie de dentro y de fuera es de deslustre fino. Parece barro natural.

Pièces de service et pour le buffet imitation argile avec bord marron. La surface est à l'intérieur et à l'extérieur bien-matte.



## Teller „CROCKER“

plate  
plato  
assiette



	cm	↑ cm	Farbe / Colour
84567	14 x 13	2,5	
84568	14 x 13	2,5	



## Teller „CROCKER“

plate  
plato  
assiette



	Ø cm	↑ cm	ltr.	Farbe / Colour
84575	20,5	3	0,50	
84576	20,5	3	0,50	



Schale „CROCKER“

bowl  
cuenco  
bol



	Ø cm	↑ cm	ltr.	Farbe / Colour
84573	16,5	4	0,50	
84574	16,5	4	0,50	



84569  
Ø 12,5 cm

84572  
Ø 16,0 cm

84577  
Ø 21,0 cm

Schale „CROCKER“

bowl  
cuenco  
bol



	Ø cm	↑ cm	ltr.	Farbe / Colour
84569	12,5	6	0,37	
84570	12,5	6	0,37	
84571	16,0	7	0,70	
84572	16,0	7	0,70	
84577	21,0	8	1,45	
84578	21,0	8	1,45	



84579

84581

Blattschale „CROCKER“

leaf  
fuente en forma de hoja  
plateau feuille



	cm	↑ cm	ltr.	Farbe / Colour
84579	30,5 x 10	7,5	0,17	
84580	30,5 x 10	7,5	0,17	
84581	42 x 14	9,5	0,65	
84582	42 x 14	9,5	0,65	

NEW FRIDA

# FRIDA'S BREAKFAST



NEW FRIDA

# FRIDA'S HEALTHY BUFFET



## Buffet & Tableware Melamin



### Schale „FRIDA LOCK“

bowl  
cuenco  
bol



Schalen lassen sich durch Drehmechanismus mit dem Ständer fest verbinden

bowls can be firmly connected to the stand by a turning mechanism

los cuencos se pueden conectar firmemente al soporte mediante un mecanismo giratorio

les bols peuvent être solidement reliés au présentoir au moyen d'un mécanisme rotatif

	Ø cm	↑ cm	ltr.	Farbe / Colour
84920	21,5	7/8,5	1,0	
84921	21,5	7/8,5	1,0	
84922	25,0	8/11	1,6	
84923	25,0	8/11	1,6	
84924	28,5	10/14	2,6	
84925	28,5	10/14	2,6	



### Haube

cover  
campana  
cloche



	Ø cm	↑ cm	fits to
06519 <span style="color:red">NEW</span>	21	17	84941, 84942
06520	30	22	84943, 84944
06521 <span style="color:red">NEW</span>	36	27	84945, 84946

NEW



84941 Ø 22,5 cm



84944 Ø 31,5 cm



84945 Ø 38,0 cm

Tablett / Platte „FRIDA LOCK“

tray  
bandeja  
plateau



Tabletts lassen sich durch Drehmechanismus mit dem Ständer fest verbinden  
trays can be firmly connected to the stand by a turning mechanism  
las bandejas se pueden conectar firmemente al soporte mediante un mecanismo giratorio  
les plateaux peuvent être solidement reliés au présentoir au moyen d'un mécanisme rotatif

	Ø cm	↑ cm	Farbe / Colour
84941	22,5	1,5/2,5	
84942	22,5	1,5/2,5	
84943	31,5	1,5/2,5	
84944	31,5	1,5/2,5	
84945	38,0	1,5/2,5	
84946	38,0	1,5/2,5	



NEW



84926



84927

Ständer „FRIDA LOCK“

stand  
soporte  
présentoir



	Ø cm	↑ cm	Farbe / Colour
84926	16,5	8	
84927	16,5	8	



NEW



84928



84929

Ständer „FRIDA LOCK“

stand  
soporte  
présentoir



	Ø cm	↑ cm	Farbe / Colour
84928	16,5	12	
84929	16,5	12	



# FRIDA



**Auf der kurzen und der langen Seite aufstellbar!**  
 Can stay on the short or long side!  
 Se puede colocar por la parte corta o larga!  
 Se peut installer sur le côté court ou long!

**GN Buffetständer**  
 GN buffet stand  
 GN soporte para buffet  
 GN présentoir buffet



	cm	GN	Farbe / Colour
15504	53,0 x 32,5 / 53,0 x 16,2	1/1 / 2/4	■
15505	32,5 x 26,5 / 26,5 x 16,2	1/2 / 1/4	■



84601  
GN 1/1



84602  
GN 1/2



84603  
GN 1/4



84604  
GN 2/4

**GN Tablett „FRIDA“**  
 GN tray  
 GN bandeja  
 GN plateau



	cm	↑ cm	GN
84601	53,0 x 32,5	2	1/1
84602	32,5 x 26,5	2	1/2
84603	26,5 x 16,2	2	1/4
84604	53,0 x 16,2	2	2/4



**mit Antirutschfüßchen**  
 with non-slip feet  
 con pies antideslizantes  
 avec pieds antidérapants



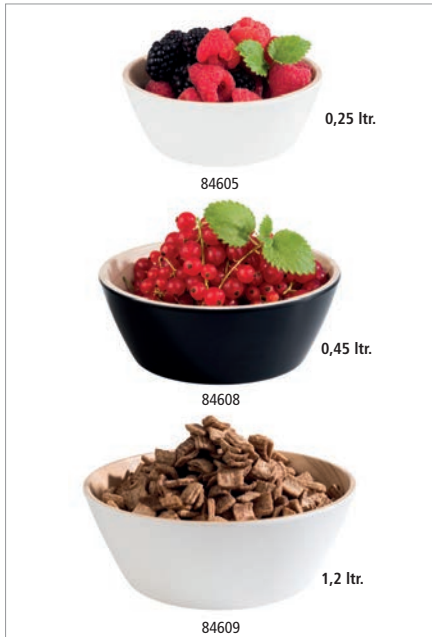

Schale „FRIDA“  
bowl  
cuenco  
bol



	Ø cm	↑ cm	ltr.	Farbe / Colour
84605	12,5	4,5	0,25	
84606	12,5	4,5	0,25	
84607	15,0	5,5	0,44	
84608	15,0	5,5	0,44	
84609	20,0	7,5	1,20	
84610	20,0	7,5	1,20	



Schale „FRIDA“  
bowl  
cuenco  
bol



	Ø cm	↑ cm	ltr.	Farbe / Colour
84611	22,0	10,5	2,2	
84612	22,0	10,5	2,2	
84613	26,5	10,5	3,4	
84614	26,5	10,5	3,4	



mit Antirutschfüßchen  
with non-slip feet  
con pies antideslizantes  
avec pieds antidérapants



Tablett „FRIDA“  
tray  
bandeja  
plateau



	cm	↑ cm	Farbe / Colour
84650	21,5 x 10,0	2,0	
84651	21,5 x 10,0	2,0	
84652	27,0 x 12,0	2,5	
84653	27,0 x 12,0	2,5	
84654	36,0 x 16,5	3,0	
84655	36,0 x 16,5	3,0	



Schale „FRIDA“  
bowl  
cuenco  
bol



	cm	↑ cm	Farbe / Colour
84615	32 x 25	3,5	
84616	32 x 25	3,5	



Schale „FRIDA“

bowl  
cuenco  
bol



	Ø cm	↑ cm	litr.	Farbe / Colour
84930	8,5	3,5	0,1	
84931	8,5	3,5	0,1	
84932	21,5	7,5	1,8	
84933	21,5	7,5	1,8	
84934	30,0	9,5	4,7	
84935	30,0	9,5	4,7	



Schale „FRIDA“

bowl  
cuenco  
bol



	cm	↑ cm	litr.	Farbe / Colour
84936	12,5 x 12,5	4,5	0,37	
84937	12,5 x 12,5	4,5	0,37	

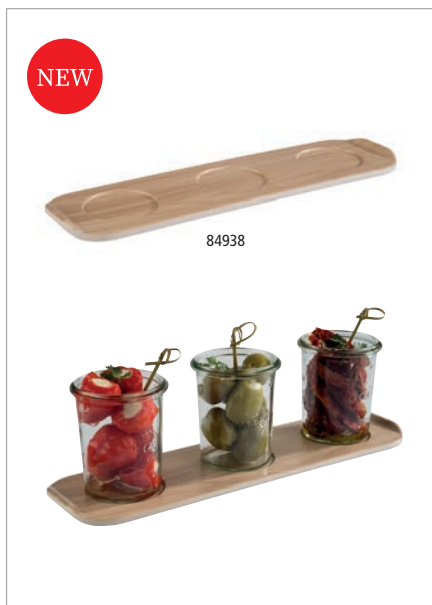

Tablett „FRIDA“

tray  
bandeja  
plateau



mit 3 Absätzen, Ø 5,4 cm  
with 3 holes, Ø 5,4 cm  
con 3 agujeros, Ø 5,4 cm  
avec 3 trous, Ø 5,4 cm

	cm	↑ cm	Farbe / Colour
84938	30 x 8,5	1	

Anwendungsbeispiel mit Weck-Glas Nr. 82312  
example of use with Weck-glasses no. 82312



**Servierset „FRIDA“, 4-tlg.**

serving set, 4 pcs. set  
set de servicio, set de 4  
set de service, set de 4



**4-teiliges Set, bestehend aus 1 Tablett mit 3 Schalen**

4 pcs set, consisting of 1 tray with 3 bowls  
set de 4, compuesto por 1 bandeja con 3 cuencos  
set de 4, composé d'un plateau avec 3 bols

	cm	↑ cm	Farbe / Colour
84939	30 x 8,5	4,5	
84940	30 x 8,5	4,5	



**GN 1/9 Schale „FRIDA“**

GN 1/9 bowl  
GN 1/9 cuenco  
GN 1/9 bol



	Ø cm	↑ cm	GN	ltr.	Farbe / Colour
84555	17,6 x 10,8	5,5	1/9	0,5	
84556	17,6 x 10,8	5,5	1/9	0,5	



**GN 1/6 Schale „FRIDA“**

GN 1/6 bowl  
GN 1/6 cuenco  
GN 1/6 bol



	Ø cm	↑ cm	GN	ltr.	Farbe / Colour
84583	17,6 x 16,2	7,5	1/6	1,0	
84584	17,6 x 16,2	7,5	1/6	1,0	



**GN 1/4 + 2/4 Schale „FRIDA“**

GN 1/4 + 2/4 bowl  
GN 1/4 + 2/4 cuenco  
GN 1/4 + 2/4 bol



	Ø cm	↑ cm	GN	ltr.	Farbe / Colour
84586	26,5 x 16,2	7,5	1/4	1,8	
84587	26,5 x 16,2	7,5	1/4	1,8	
	Ø cm	↑ cm	GN	ltr.	Farbe / Colour
84564	53 x 16,2	7,5	2/4	3,65	
84565	53 x 16,2	7,5	2/4	3,65	



**GN 1/2 Schale**

GN 1/2 bowl  
GN 1/2 cuenco  
GN 1/2 bol



	Ø cm	↑ cm	GN	ltr.	Farbe / Colour
84589	32,5 x 26,5	7,5	1/2	4,0	
84590	32,5 x 26,5	7,5	1/2	4,0	

## Buffet & Tableware Melamin



### Schale „FRIDA“

bowl  
cuenco  
bol



	cm	↑ cm	ltr.	Farbe / Colour
84558	16,5 x 16,5	5,5	0,85	
84559	16,5 x 16,5	5,5	0,85	



### Schale „FRIDA“

bowl  
cuenco  
bol



	cm	↑ cm	ltr.	Farbe / Colour
84561	25 x 25	7,5	2,65	
84562	25 x 25	7,5	2,65	



### GN 1/4 Tablett „FRIDA“

GN 1/4 tray  
GN 1/4 bandeja  
GN 1/4 plateau



	cm	↑ cm	ltr.	Farbe / Colour
84595	26,5 x 16,2	3	1/4	
84596	26,5 x 16,2	3	1/4	



### Tablett „FRIDA“

tray  
bandeja  
plateau



	cm	↑ cm	ltr.	Farbe / Colour
84598	35,5 x 26,0	3		
84599	35,5 x 26,0	3		



### Schale „FRIDA“

bowl  
cuenco  
bol



	cm	↑ cm	ltr.	Farbe / Colour
84592	25 x 25	12	3,5	
84593	25 x 25	12	3,5	



Deckel „PURE“ mit Löffelaussparung / cover with notched for spoons / tapa con espacio para la cuchara / couvercle avec encoche pour la louche

	cm	↑ cm	fits to
83601	25 x 25	1,5	84561, 84562, 84592, 84593, 84594



### Schale „FRIDA STONE“

bowl  
cuenco  
bol



	cm	↑ cm	ltr.	Farbe / Colour
84594	25 x 25	12	3,5	



Schale „FRIDA STONE“

bowl  
cuenco  
bol



	Ø cm	↑ cm	GN	Farbe / Colour
84560	16,5 x 16,5	5,5	0,85	■
84563	25,0 x 25,0	7,5	2,65	■



Tablett „FRIDA STONE“

tray  
bandeja  
plateau



	Ø cm	↑ cm	GN	Farbe / Colour
84597	26,5 x 16,2	3	1/4	■
84600	35,5 x 26,0	3	-	■



GN 1/9 Schale „FRIDA STONE“

GN 1/9 bowl  
GN 1/9 cuenco  
GN 1/9 bol



	cm	↑ cm	GN	litr.	Farbe / Colour
84557	17,6 x 10,8	5,5	1/9	0,5	■



GN 1/6 Schale „FRIDA STONE“

GN 1/6 bowl  
GN 1/6 cuenco  
GN 1/6 bol



	cm	↑ cm	GN	litr.	Farbe / Colour
84585	17,6 x 16,2	7,5	1/6	1,0	■



GN 1/4 Schale

GN 1/4 bowl  
GN 1/4 cuenco  
GN 1/4 bol



	cm	↑ cm	GN	litr.	Farbe / Colour
84588	26,5 x 16,2	7,5	1/4	1,8	■



GN 1/2 Schale „FRIDA STONE“

GN 1/2 bowl  
GN 1/2 cuenco  
GN 1/2 bol



	cm	↑ cm	GN	litr.	Farbe / Colour
84591	32,5 x 26,5	7,5	1/2	4,0	■



GN 2/4 Schale „FRIDA STONE“

GN 2/4 bowl  
GN 2/4 cuenco  
GN 2/4 bol



	cm	↑ cm	GN	litr.	Farbe / Colour
84566	53 x 16,2	7,5	2/4	3,65	■

# FLOWER POT



## Schale „FLOWER POT“

bowl  
cuenco  
bol



	Ø cm	↑ cm	ltr.	Farbe / Colour
84470	6	3,5	0,04	
84471	6	3,5	0,04	
84472	6	3,5	0,04	

	Ø cm	↑ cm	ltr.	Farbe / Colour
84473	9	8,5	0,30	
84474	9	8,5	0,30	
84475	9	8,5	0,30	

	Ø cm	↑ cm	ltr.	Farbe / Colour
84476	12	3,5	0,20	
84478	12	3,5	0,20	

	Ø cm	↑ cm	ltr.	Farbe / Colour
84479	13	15	1,00	
84481	13	15	1,00	

	Ø cm	↑ cm	ltr.	Farbe / Colour
84482	20	9	1,80	
84484	20	9	1,80	

Deckel „UNIVERSAL“ mit Löffelaussparung / cover with notched for spoons  
tapa con espacio para la cuchara / couvercle avec encoche pour la cuillère

	Ø cm	↑ cm	fits to
15341	20	1,5	84482, 84483, 84484



Schale „GLAMOUR“  
bowl  
cuenco  
bol



	∅ cm	↑ cm	ltr.
84365	8	3	0,05



Schale „GLAMOUR“  
bowl  
cuenco  
bol



	∅ cm	↑ cm	ltr.
84366	12	5	0,25



Schale „GLAMOUR“  
bowl  
cuenco  
bol



	∅ cm	↑ cm	ltr.
84367	15	8	0,70



Tablett „GLAMOUR“  
tray  
bandeja  
plateau



	cm	↑ cm
84377	22 x 12	3,0
84378	37 x 11	2,5

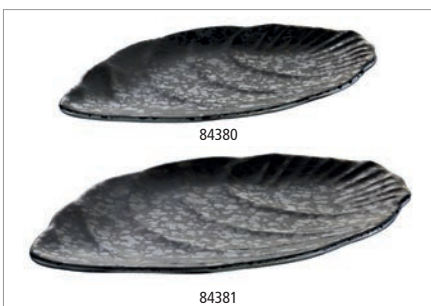

Tablett „GLAMOUR“  
tray  
bandeja  
plateau



	cm	↑ cm
84380	25,0 x 15,5	1,5
84381	30,5 x 19,0	1,5



Tablett „GLAMOUR“  
tray  
bandeja  
plateau



	cm	↑ cm
84379	30 x 11	3

# OAK



Tablett „OAK“  
tray  
bandeja  
plateau



	cm	↑ cm	→ cm
84431	17,5 x 14,5	1,5	Griff / handle 6,5
84432	22,0 x 12,0	2,0	Griff / handle 11,0



Tablett „OAK“  
tray  
bandeja  
plateau



	cm	↑ cm
84433	20 x 20	2,5



Schale „OAK“  
bowl  
cuenco  
bol



	cm	↑ cm
84434	11,5 x 7,0	2,5
84435	25,0 x 6,5	3,5



GN Tablett „OAK“  
GN tray  
GN bandeja  
GN plateau



Eichenoptik  
oak wood effect  
imitación madera de roble  
imitation chêne

	cm	↑ cm	GN
84720	53,0 x 32,5	1	1/1
84721	32,5 x 26,5	1	1/2
84722	32,5 x 17,6	1	1/3
84723	26,5 x 16,2	1	1/4
84724	53,0 x 16,2	1	2/4



# OAK



Die Melaminplatten (Holzoptik Eiche) haben eine leichte Struktur und wirken optisch wie aus Holz gefertigt.

The melamine trays (superb oak wood effect) have a lightweight structure and look visually as made of wood.

Las bandejas de melamina (imitación madera de roble) tienen una estructura ligera y parecen estar hechas de madera.

Les plateaux de mélamine (imitation bois de chêne) ont une structure légère et donnent une impression visuelle de bois.



## Tablett „OAK“

tray  
bandeja  
plateau



	∅ cm	↑ cm	→ cm
84177	30	1,5	Griff / handle 12



## Tablett „OAK“

tray  
bandeja  
plateau



	cm	↑ cm	→ cm
84178	40 x 20	1,5	Griff / handle 13



## Tablett „OAK“

tray  
bandeja  
plateau



	cm	↑ cm	→ cm
84179	48 x 20	1,5	Griff / handle 13

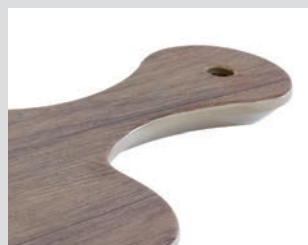



Die Melaminplatten (Holzoptik Eiche hell) haben eine leichte Struktur und wirken optisch wie aus Holz gefertigt.

The melamine trays (wood look light oak) have a lightweight structure and look visually as made of wood.

Las bandejas de melamina (imitación madera de roble claro) tienen una estructura ligera y parecen estar hechas de madera.

Les plateaux de mélamine (imitation bois de chêne clair) ont une structure légère et donnent une impression visuelle de bois.

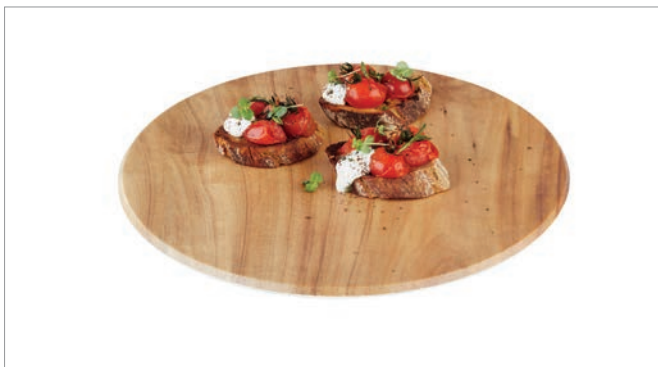

Tablett „OAK LIGHT“

tray  
bandeja  
plateau



	Ø cm	↑ cm
84262	35	3
84263	44	3



Tablett „OAK LIGHT“

tray  
bandeja  
plateau



	cm	↑ cm
84264	44 x 25	1,5



Tablett „OAK LIGHT“

tray  
bandeja  
plateau



	cm	↑ cm
84265	65 x 26	3

# OAK LIGHT GN



HOLZ OPTIK



84205  
GN 1/1



84206  
GN 1/2



84207  
GN 1/3

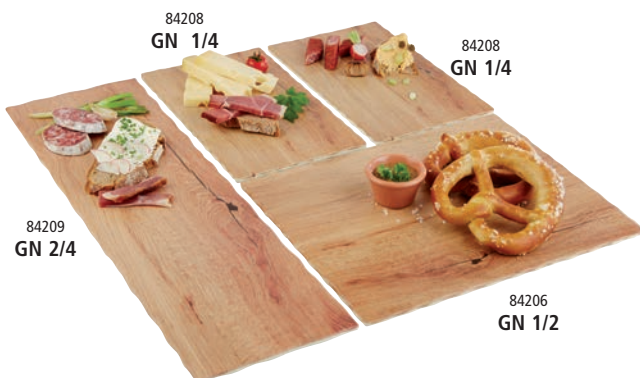

GN Tablett „OAK LIGHT“

GN tray  
GN bandeja  
GN plateau



	cm	↑ cm	GN
84205	53,0 x 32,5	1,5	1/1
84206	32,5 x 26,5	1,5	1/2
84207	32,5 x 17,6	1,5	1/3
84208	26,5 x 16,2	1,5	1/4
84209	53,0 x 16,2	1,5	2/4



**Holzoptik Eiche hell**  
wood look oak light  
aspecto madera, roble claro  
aspect bois chêne clair



**mit Antirutschfüßchen**  
with non-slip feet  
con pies antideslizantes  
avec pieds antidérapants

GN 1/1	GN 1/2	GN 1/4	GN 2/4
	GN 1/2	GN 1/4	
GN 1/3	GN 1/3	GN 1/3	

# TIMBER



Die Melaminplatten (Holzoptik Fichte) haben eine leichte Struktur und wirken optisch wie aus Holz gefertigt.

The melamine trays (superb spruce wood effect – timber) have a lightweight structure and look visually as made of wood.

Las bandejas de melamina (imitación madera de picea) tienen una estructura ligera y parecen estar hechas de madera.

Les plateaux de mélamine (imitation bois d'épicéa) ont une structure légère et donnent une impression visuelle de bois.



## Schale „TIMBER“

bowl  
cuenco  
bol



	cm	↑ cm	ltr.
84893	28 X 25	7,5	1,5
84894	43 X 24	7,5	2,0



## Schale „TIMBER“

bowl  
cuenco  
bol



	Ø cm	↑ cm	ltr.
84895	25,5	15	3,0



Teller „TIMBER“

plate  
plato  
assiette



	Ø cm	↑ cm
84890	15	1,5



Teller „TIMBER“

plate  
plato  
assiette



	Ø cm	↑ cm
84891	21,5	2,5
84892	27,5	3,0



Tablett „TIMBER“

tray  
bandeja  
plateau



	Ø cm	↑ cm
84266	35	3
84267	44	3



Tablett „TIMBER“

tray  
bandeja  
plateau



	cm	↑ cm
84268	44 x 25	1,5



Tablett „TIMBER“

tray  
bandeja  
plateau



	cm	↑ cm
84269	65 x 26	3



Tablett „TIMBER“

tray  
bandeja  
plateau



	cm	↑ cm
84256	70 x 26	3

# SLATE



Die schwarzen Melaminplatten überzeugen mit ihrem edlen und schlichten Schieferlook und einer rauhen Oberfläche.

The black melamine trays convince with their noble and simple slate look and a rough surface.

Las bandejas de melamina negras convencen por su aspecto de pizarra elegante y discreto y una superficie áspera.

Les plateaux en mélamine noirs convainquent grâce au aspect de l'ardoise élégant et discret et une surface rugueuse.



## GN Tablett „SLATE“

GN tray  
GN bandeja  
GN plateau



	cm	↑ cm	GN
83955	53,0 x 32,5	1	1/1
83956	32,5 x 26,5	1	1/2
83957	32,5 x 17,6	1	1/3
83958	26,5 x 16,2	1	1/4
83971	53,0 x 16,2	1	2/4



## GN Tablett „SLATE“

GN tray  
GN bandeja  
GN plateau



	cm	↑ cm	GN
83981	53 x 32,5	1,5	1/1



## GN Tablett „SLATE“

GN tray  
GN bandeja  
GN plateau



massive Metallgriffe verchromt inkl. fest verschraubten 4 cm Distanzstücken  
chrome plated handles, incl. mounted 4 cm distance pillars  
asas cromadas, incluye distanciadores a 4 cm  
poignées chromées, distance approx. 4 cm

	cm	↑ cm	GN
83980	53 x 32,5	6	1/1



Tablett „SLATE“

tray  
bandeja  
plateau



	cm	↑ cm
84960	28 x 17,5	2,5



Ø 2,5 cm

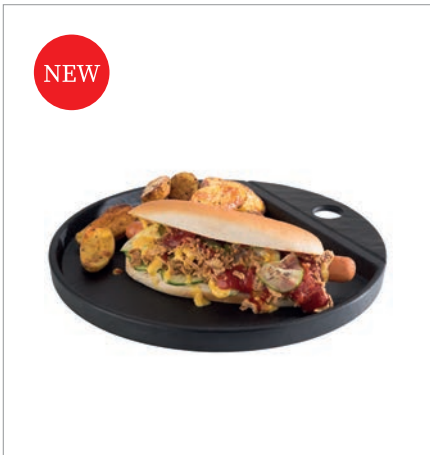

Tablett „SLATE“

tray  
bandeja  
plateau



	Ø cm	↑ cm
84961	28	2,5



Ø 2,5 cm



Tablett „SLATE“

tray  
bandeja  
plateau



	Ø cm	↑ cm
83992	30	1
83994	40	1



Schale „SLATE“

bowl  
cuenco  
bol



	cm	↑ cm	litr.
84244	19 x 19	9	1,5
84245	25 x 25	12	3,8

Deckel „PURE“ mit Löffelaussparung / cover with notched for spoons  
tapa con espacio para la cuchara / couvercle avec encoche pour la louche

	cm	↑ cm	fits to
83600	19 x 19	1,5	84244
83601	25 x 25	1,5	84245

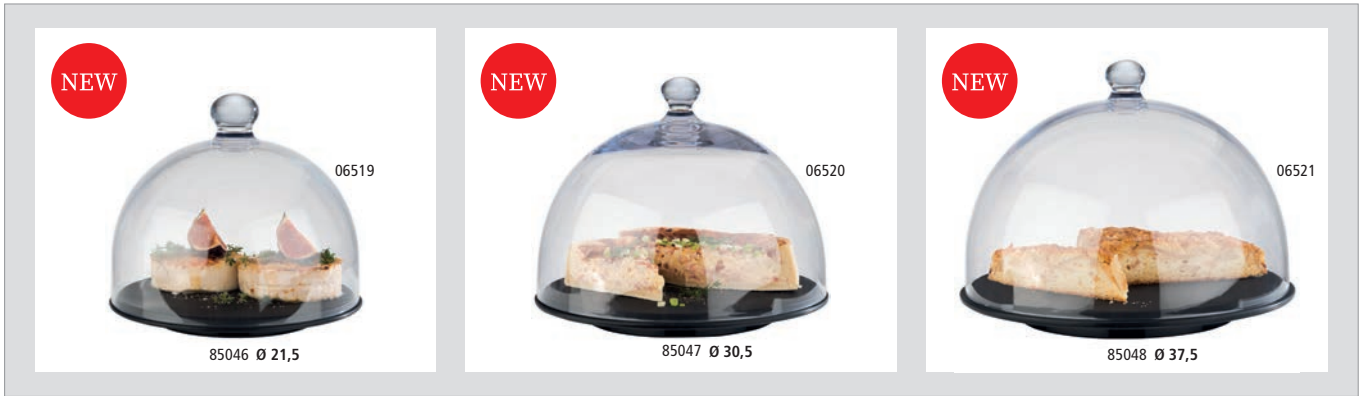

**Torten- / Konditorplatte „SLATE“**  
 cake stand  
 soporte para pastel  
 présentoir à gâteaux



Rand fixiert die Haube, mit Antirutsch-Füßchen  
 carved edge fixes the cover, with non-slip feet  
 ranura para fijar bien la campana, con pies antideslizantes  
 bord rainuré pour maintenir ferme la cloche, avec pieds antidérapants

	Ø cm	↑ cm
85046	21,5	2,5
85047	30,5	3,5
85048	37,5	4

**Frischhalte- Haube / cover / campana / cloche**



	Ø cm	↑ cm	fits to
06519 <small>NEW</small>	21	17	85046
06520	30	22	85047
06521 <small>NEW</small>	36	27	85048



**Tablett „SLATE“**  
 tray  
 bandeja  
 plateau



	Ø cm	↑ cm	→ cm	
84241	23,0	1,5	10	Ø Loch 2 cm
84242	33,5	1,5	14	Ø Loch 2,5 cm

**Frischhalte- Haube / cover / campana/ cloche**



	Ø cm	↑ cm	fits to
06520	30,0	22	84242, 84177, 83891, 83890, 83884, 15303, 998, 975, 469, 468, 463, 462 46,
15351	20,5	10	84241



# SLATE ROCK



Buffet & Tableware  
Melamin



## Tablett „SLATE-ROCK“

tray  
bandeja  
plateau



Die schwarzen Melaminplatten überzeugen mit ihrem Schieferlook  
The black melamine trays convince with their slate look  
Las bandejas de melamina negras convencen por su aspecto de pizarra  
Les plateaux en mélamine noirs convainquent grâce au aspect de l'ardoise

	∅ cm	↑ cm	→ cm
84257	30	1,5	Griff 12
	cm	↑ cm	→ cm
84258	40 x 20	1,5	Griff 13
84259	48 x 20	1,5	Griff 13

## Buffet & Tableware Melamin



### Tablett „SLATE-ROCK“

tray  
bandeja  
plateau



Die schwarzen Melaminplatten überzeugen mit ihrem Schieferlook

The black melamine trays convince with their slate look

Las bandejas de melamina negras convencen por su aspecto de pizarra

Les plateaux en mélamine noirs convainquent grâce au aspect de l'ardoise

	cm	↑ cm
84246	20 x 10	2
84247	30 x 10	2
84248	30 x 15	2

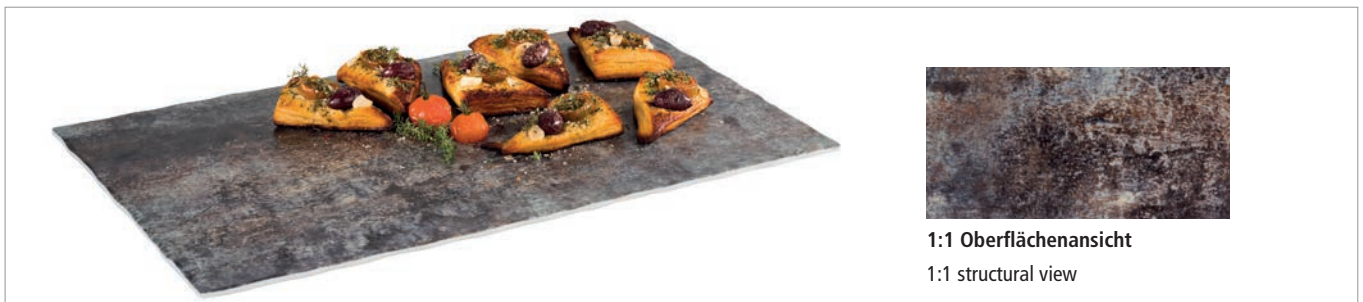

1:1 Oberflächenansicht

1:1 structural view

### GN Tablett „ROCKFACE“

GN tray  
GN bandeja  
GN plateau



die Melaminplatten (Steinoptik) haben eine leicht wellige Oberfläche und wirken optisch wie ein Naturstein

the melamine trays (imitation of stone) have a slightly wavy surface and look visually as made of natural stone

las bandejas de melamine (imitación piedra) tienen una superficie ligeramente ondulada y parecen estar hechas de piedra natural

les plateaux de mélamine (imitation pierre) ont une surface légèrement ondulée et donnent une impression visuelle de pierre naturelle

	cm	↑ cm	GN
84770	53,0 x 32,5	1,5	1/1
84771	32,5 x 26,5	1,5	1/2
84772	32,5 x 17,6	1,5	1/3
84773	26,5 x 16,2	1,5	1/4
84774	53,0 x 16,2	1,5	2/4



**GN Tablett „ZERO“**

GN tray  
GN bandeja  
GN plateau



glatte, hochglänzende Oberfläche  
smooth and shiny surface  
superficie lisa con acabado brillante  
surface lisse et finition brillante

	cm	↑ cm	GN	Farbe / Colour
84185	53,0 x 32,5	1,5	1/1	
84186	32,5 x 26,5	1,5	1/2	
84187	32,5 x 17,6	1,5	1/3	
84188	26,5 x 16,2	1,5	1/4	
84189	53,0 x 16,2	1,5	2/4	
84195	53,0 x 32,5	1,5	1/1	
84196	32,5 x 26,5	1,5	1/2	
84197	32,5 x 17,6	1,5	1/3	
84198	26,5 x 16,2	1,5	1/4	
84199	53,0 x 16,2	1,5	2/4	



**GN Tablett „DRIFTWOOD“**

GN tray  
GN bandeja  
GN plateau



die Melaminplatten (Holzoptik) haben eine leicht wellige Oberfläche und wirken optisch wie aus Holz gefertigt  
the melamine trays (wood look) have a slightly wavy surface and look visually as made of natural wood  
las bandejas de melamine (imitación madera) tienen una superficie ligeramente ondulada y parecen estar hechas de madera natural  
les plateaux de mélamine (imitation bois) ont une surface légèrement ondulée et donnent une impression visuelle de bois naturelle

	cm	↑ cm	GN
84180	53,0 x 32,5	1,5	1/1
84181	32,5 x 26,5	1,5	1/2
84182	32,5 x 17,6	1,5	1/3
84183	26,5 x 16,2	1,5	1/4
84184	53,0 x 16,2	1,5	2/4

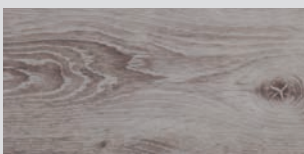

1:1 Oberflächenansicht  
1:1 structural view

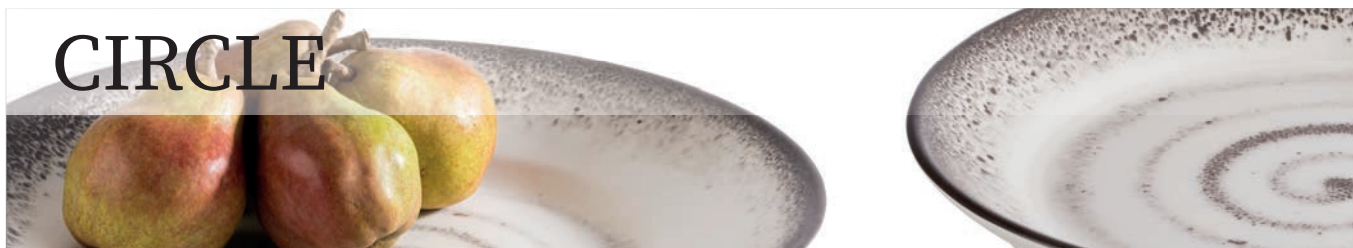

# CIRCLE



## Tablett „CIRCLE“

plate / tray  
plato / bandeja  
assiette / plateau



	Ø cm	↑ cm	Farbe / Colour
84875	32,0	3,5	
84876	40,5	5,5	



# LA VIDA



## Tablett „LA VIDA“

plate / tray  
plato / bandeja  
assiette / plateau



	Ø cm	↑ cm	Farbe / Colour
84165	32,0	3,5	
84168	40,5	5,5	

	Ø cm	↑ cm	Farbe / Colour
84161	32,0	3,5	
84170	40,5	5,5	

	Ø cm	↑ cm	Farbe / Colour
84171	32,0	3,5	
84172	40,5	5,5	

# MARONE



Eine derbe Oberflächenstruktur schafft ein natürliches Erscheinungsbild. Die schwarzen Schalenvarianten mit braunem Rand inszenieren Ihr Gericht sehr stilvoll.

A rough surface structure creates a natural appearance. The black bowls and trays with brown border stage your dishes in a very stylish way.

La estructura rugosa de la superficie crea una apariencia natural. Los diferentes cuencos negros con borde marrón ponen con mucho estilo en escena sus platos.

La structure de surface rugueuse crée une apparence naturelle. Les différents bols noirs avec rebord marron mettent élégamment en scène vos plats.



84101

## Blattschale „MARONE“

leaf  
fuente en forma de hoja  
plateau feuille



	cm	↑ cm	ltr.
84100	25,5 x 14	5,5	0,4
84101	36,0 x 19	8,0	0,9



84104

## Tablett „MARONE“

tray  
bandeja  
plateau



	cm	↑ cm
84104	22,5 x 15	3
84105	27,5 x 11	2



## Tablett „MARONE“

tray  
bandeja  
plateau



	cm	↑ cm
84103	14,5 x 14,5	2



## Tablett „MARONE“

tray  
bandeja  
plateau



	cm	↑ cm
84106	26,5 x 16,5	4



Schale „MARONE“

bowl  
cuenco  
bol



	cm	↑ cm	ltr.
84731	16,5 x 10	5,5	0,25
84732	22,0 x 13	7,5	0,6
84733	27,5 x 19	9,0	1,4



Teller „MARONE“

plate  
plato  
assiette



	Ø cm	↑ cm
84728	16,0	2,5
84729	20,5	2,5
84730	28,0	3,5



Schale „MARONE“

bowl  
cuenco  
bol



	Ø cm	↑ cm	ltr.
84109	11	5,5	0,2



Schale „MARONE“

bowl  
cuenco  
bol



	Ø cm	↑ cm	ltr.
84107	8,5	2,5	0,05
84108	11,5	3,0	0,04



Tablett „MARONE“

tray  
bandeja  
plateau



	cm	↑ cm
84117	19,5 x 9,5	2
84118	39,0 x 16,0	3



Tablett „MARONE“

tray  
bandeja  
plateau



	cm	↑ cm
84119	32,5 x 23,5	4,5



Schale „MARONE“

bowl  
cuenco  
bol



	Ø cm	↑ cm	ltr.
84174	30,5	8,5	2



Schale „MARONE“

bowl  
cuenco  
bol



	Ø cm	↑ cm	ltr.
84110	14	6,0	0,30
84111	19	8,0	0,80
84112	21	8,5	1,00
84113	24	9,5	1,40



Schale „MARONE“

bowl  
cuenco  
bol



	cm	↑ cm	ltr.
84114	23,5 x 23,5	6,5	0,70

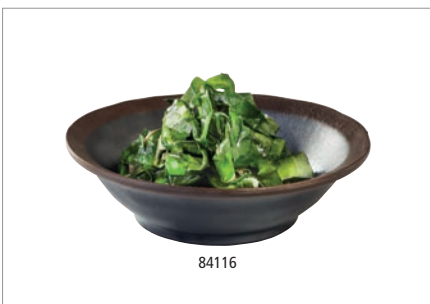

Schale „MARONE“

bowl  
cuenco  
bol



	Ø cm	↑ cm	ltr.
84115	11	3,5	0,13
84116	14	4,0	0,20

# DARK WAVE



## GN Tablett „DARK WAVE“

GN tray  
GN bandeja  
GN plateau



	cm	↑ cm	GN
84900	53,0 x 32,5	2	1/1
84901	32,5 x 26,5	2	1/2
84902	32,5 x 17,6	2	1/3
84903	53,0 x 16,2	2	2/4

GN 1/1	GN 1/2	GN 2/4	GN 1/3	mit Antirutsch- füßchen non-slip feet
	GN 1/2		GN 1/3	
			GN 1/3	



## Tablett „DARK WAVE“

tray  
bandeja  
plateau



	cm	↑ cm
84904	14 x 14	2





Tablett „DARK WAVE“

tray  
bandeja  
plateau



	cm	↑ cm
84905	23 x 10,5	1,5
84906	29 x 12,0	1,5

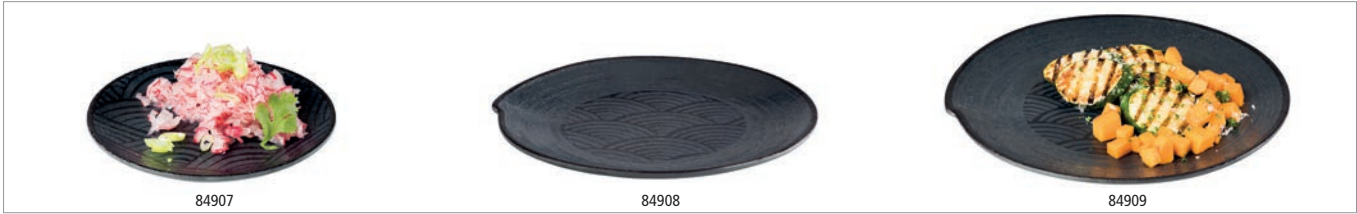

Teller „DARK WAVE“

plate  
plato  
assiette



	Ø cm	↑ cm
84907	14,5	1,5
84908	22,0	2,0
84909	27,0	2,5



Schale „DARK WAVE“

bowl  
cuenco  
bol



	Ø cm	↑ cm	ltr.
84910	17,5	5,0	0,50
84911	22,5	5,0	0,75
84912	32,0	3,5	-
84913	40,5	5,5	-



Schale „DARK WAVE“

bowl  
cuenco  
bol



	cm	↑ cm	ltr.
84914	18 x 18	10,0	1,6
84915	23 x 23	11,5	2,9

# ZEN

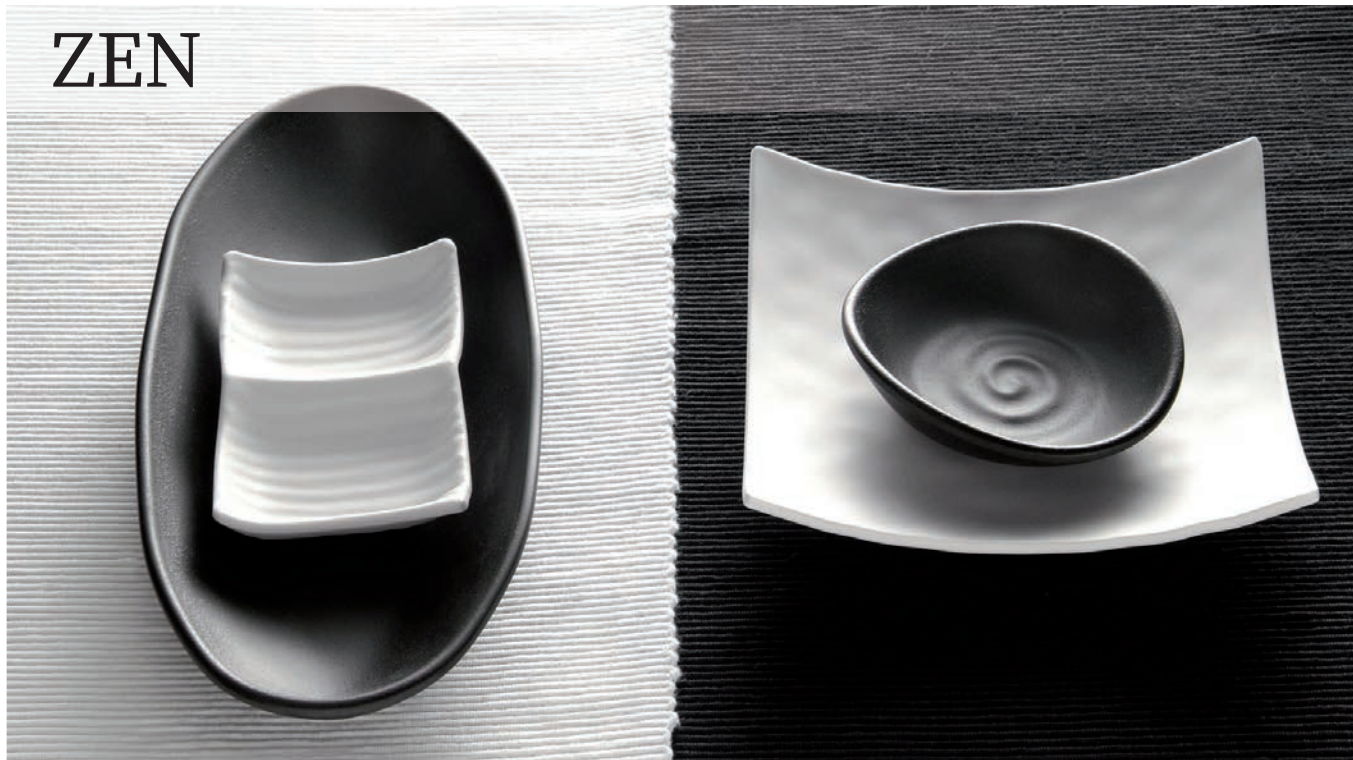

Fernöstliche Tisch- und Buffetartikel präsentiert die Serie ZEN. Die Optik entspricht dem japanischen Steingut.

The ZEN series presents Far Eastern table and buffet articles. The appearance is that of Japanese stoneware.

La colección ZEN presenta artículos de buffet y mesa para la cocina oriental. Su aspecto recuerda al gres japonés.

La collection ZEN présente des articles de buffet et de table pour la cuisine orientale. L'aspect de la mélamine rappelle le grès japonais.



Schale „ZEN“  
bowl  
cuenco  
bol



	Ø cm	↑ cm	ltr	Farbe / Colour
83928	31	8,5	2,5	White
83929	31	8,5	2,5	Black



Schale „ZEN“  
bowl  
cuenco  
bol



	Ø cm	↑ cm	ltr.	Farbe / Colour
84354	22,5	12,5	0,80	White
84355	22,5	12,5	0,80	Black



Schale „ZEN“  
bowl  
cuenco  
bol



	cm	↑ cm	ltr.	Farbe / Colour
83710	21 x 21	11	1,40	White
83712	21 x 21	11	1,40	Black



Schale „ZEN“

bowl  
cuenco  
bol



	Ø cm	↑ cm	ltr.	Farbe / Colour
84348	10,0	7,0	0,08	■
84350	12,5	8,5	0,15	■
84352	16,0	10,0	0,30	■

	Ø cm	↑ cm	ltr.	Farbe / Colour
84349	10,0	7,0	0,08	■
84351	12,5	8,5	0,15	■
84353	16,0	10,0	0,30	■



stapelbar  
stackable



Schale „ZEN“

bowl  
cuenco  
bol



	cm	↑ cm	ltr.	Farbe / Colour
83735	25,0 x 13,5	4	0,25	■
83739	30,5 x 17,5	5	0,60	■



Schale „ZEN“

bowl  
cuenco  
bol



	cm	↑ cm	ltr.	Farbe / Colour
83714	17,5 x 17,5	7	0,5	■
83716	17,5 x 17,5	7	0,5	■



Schale „ZEN“

bowl  
cuenco  
bol



	cm	↑ cm	ltr.	Farbe / Colour
83725	10,5 x 10,5	3	0,06	■
83727	10,5 x 10,5	3	0,06	■



Dipschälchen „ZEN“

dip bowl  
cuenco para dip  
bol para dip



	∅ cm	↑ cm	ltr.	Farbe / Colour
83721	8	1,5	0,03	■
83723	8	1,5	0,03	■



Schale „ZEN“

bowl  
cuenco  
bol



	cm	↑ cm	ltr.	Farbe / Colour
83718	12 x 12	4	0,2	■
83720	12 x 12	4	0,2	■



Schale „ZEN“

bowl  
cuenco  
bol



	cm	↑ cm	ltr.	Farbe / Colour
83726	13 x 11	3,5	0,1	■
83728	13 x 11	3,5	0,1	■



Schale „ZEN“

bowl  
cuenco  
bol



	cm	↑ cm	ltr.	Farbe / Colour
83730	11 x 10	3	0,04	■
83732	11 x 10	3	0,04	■



Schale „ZEN“

bowl  
cuenco  
bol



	cm	↑ cm	ltr.	Farbe / Colour
83722	17,5 x 15,5	5,5	0,2	■
83724	17,5 x 15,5	5,5	0,2	■



Schale „ZEN“

bowl  
cuenco  
bol



	cm	↑ cm	ltr.	Farbe / Colour
83934	14,5 x 12,5	5	0,2	■
83935	14,5 x 12,5	5	0,2	■



Schale „ZEN“

bowl  
cuenco  
bol



	∅ cm	↑ cm	ltr.	Farbe / Colour
83932	11,5	4	0,15	■
83933	11,5	4	0,15	■



Schale „ZEN“

bowl  
cuenco  
bol



	cm	↑ cm	ltr.	Farbe / Colour
83946	9 x 7	2,5	0,05	■
83947	9 x 7	2,5	0,05	■



Schale „ZEN“

bowl  
cuenco  
bol



	cm	↑ cm	Farbe / Colour
83948	14 x 9	2,5	■
83949	14 x 9	2,5	■



**Tablett / Teller „ZEN“**

tray / plate  
bandeja / plato  
plateau / assiette



	∅ cm	↑ cm	Farbe / Colour
83940	28	3	
83941	28	3	



**Tablett „ZEN“**

tray  
bandeja  
plateau



	cm	↑ cm	Farbe / Colour
83734	23,5 x 23	5,5	
83736	23,5 x 23	5,5	



**Tablett / Sushiboard „ZEN“**

tray / sushiboard  
bandeja para sushi  
plateau sushi



	cm	↑ cm	Farbe / Colour
83742	22,5 x 9,5	3	
83744	22,5 x 9,5	3	



**Tablett / Sushiboard „ZEN“**

tray / sushiboard  
bandeja para sushi  
plateau sushi



	cm	↑ cm	Farbe / Colour
83738	22 x 12	3	
83740	22 x 12	3	

# FUSION



Die Oberflächen der Serie FUSION sind innen hoch glänzend und außen mattiert. Das besondere Design beansprucht höchste Aufmerksamkeit und bringt Speisen optimal zur Geltung. Die Speisen werden noch mehr in den Blickpunkt gerückt.

The surfaces of the FUSION series have a mirror shiny inside and a matte outside. The unique design demands the utmost attention. The food moves even more in the focus.

Las superficies de la serie FUSION tienen un interior brillante y un exterior mate. El diseño único exige la máxima atención. Los platos reciben un enfoque aún mayor.

Les surfaces de la série FUSION sont brillantes à l'intérieur et mates à l'extérieur. Le design spéciale exige la plus grande attention. Les plats sont mise encore plus dans le centre de l'attention.



## Schale „FUSION“

owl  
cuenco  
bol



	Ø cm	↑ cm	ltr.
84022	11	7,0	0,3
84023	17	8,5	1,0
84024	20	8,0	1,2



## Tablett „FUSION“

tray  
bandeja  
plateau



	cm	↑ cm
84025	23,5 x 7,5	2

# SINUS



Charakterstark und mit dem Anspruch an Funktionalität und Design präsentiert sich die Buffetserie SINUS. Die großzügigen Flächen für die Speisenpräsentation sind ausdrucksstark eingefasst und gewährleisten ein optimales Handling.

The SINUS buffet series is characterful and with a high standard of functionality and design. The spacious areas for the food presentation are expressively enclosed and ensure optimal handling in everyday dining.

La serie de buffet SINUS demuestra un carácter fuerte y tiene un alto nivel de funcionalidad y diseño. Las áreas espaciales para la presentación de la comida son expresivamente enmarcadas y aseguran un manejo óptimo en la gastronomía.

La série de buffet SINUS est pleine de caractère et avec un haut niveau de fonctionnalité et de design. Les zones spacieuses pour la présentation de la nourriture sont expressivement encadrées et assurent une maniabilité optimale dans la restauration.



## GN Tablett „SINUS“

GN tray  
GN bandeja  
GN plateau



	cm	↑ cm	GN	Farbe / Colour
84230	53 x 32,5	2	1/1	White
84231	53 x 16,2	2	2/4	White
	cm	↑ cm	GN	Farbe / Colour
84260	53 x 32,5	2	1/1	Black
84261	53 x 16,2	2	2/4	Black



## Schale „SINUS“

bowl  
cuenco  
bol



	cm	↑ cm	ltr.
84229	10,5 x 10,5	4,0	0,1
84232	21,0 x 21,0	9,0	1,5
84233	25,0 x 25,0	11,0	2,4
84234	28,5 x 28,5	12,5	3,5



# HALFTONE



## Fingerfood Löffel „HALFTONE“

party spoon  
cuchara party  
cuillère party



	Ø cm	↑ cm
84158	5,5	7



## Fingerfood Löffel „HALFTONE“

party spoon  
cuchara party  
cuillère party



	cm	↑ cm
84128	14,5 x 4,5	4,5



## Tablett „HALFTONE“

tray  
bandeja  
plateau



	cm	↑ cm
84124	20,5 x 12,5	3
84125	24,5 x 15,0	3
84127	34,5 x 21,5	3



## Tablett „HALFTONE“

tray  
bandeja  
plateau



	cm	↑ cm
84126	29 x 18	4



**Schale „HALFTONE“**

bowl  
cuenco  
bol



	∅ cm	↑ cm	ltr.
84217	8	4	0,1



**Schale „HALFTONE“**

bowl  
cuenco  
bol



	∅ cm	↑ cm	ltr.
84218	8,5	3,5	0,05



84130

**Schale „HALFTONE“**

bowl  
cuenco  
bol



	cm	↑ cm	ltr.
84130	11,5 x 7,0	4,0	0,05
84131	14,0 x 8,0	4,5	0,10
84132	15,0 x 9,5	5,0	0,15



84134

**Schale „HALFTONE“**

bowl  
cuenco  
bol



	cm	↑ cm	ltr.
84133	17,5 x 13,5	6,5	0,35
84134	24,0 x 17,5	7,5	0,8



84136

**Schale „HALFTONE“**

bowl  
cuenco  
bol



	cm	↑ cm	ltr.
84135	16,5	7,5	0,65
84136	19,0	8,5	1,00



**Schale „HALFTONE“**

bowl  
cuenco  
bol



	cm	↑ cm	ltr.
84137	26	9	1,5

# TAO



## Schale, rund „TAO“ bowl, round cuenco, redondo bol, rond



	cm	↑ cm	ltr.	Farbe / Colour
83648	10,5 x 10,0	6,5 / 3,0	0,07	White
83651	13,5 x 12,5	8,5 / 4,0	0,15	White
83654	17,0 x 16,0	10,5 / 4,5	0,3	White
	cm	↑ cm	ltr.	Farbe / Colour
83649	10,5 x 10,0	6,5 / 3,0	0,07	Black
83652	13,5 x 12,5	8,5 / 4,0	0,15	Black
83655	17,0 x 16,0	10,5 / 4,5	0,3	Black



## Schale, quadratisch „TAO“ bowl, square cuenco, cuadrado bol creux carré



	cm	↑ cm	ltr.	Farbe / Colour
83642	30,5 x 30,5	10	3,3	White
83643	30,5 x 30,5	10	3,3	Black



## Schale, rechteckig „TAO“ bowl, rectangular cuenco, rectangular bol creux rectangulaire



	cm	↑ cm	ltr.	Farbe / Colour
83639	32,5 x 17,5	10	1,8	White
83640	32,5 x 17,5	10	1,8	Black

# APART



## GN Tablett „APART“

GN tray  
GN bandeja  
GN plateau



	cm	↑ cm	GN
83828	53,0 x 32,5	2,5	1/1
83830	32,5 x 26,5	2,5	1/2
83832	32,5 x 17,6	2,5	1/3



## Tablett „APART“

tray  
bandeja  
plateau



	cm	↑ cm
83834	23,0 x 23,0	2,5
83836	33,0 x 33,0	2,5



## Schale, rund „APART“

bowl, round  
cuenco, redondo  
bol, rond



	Ø cm	↑ cm	litr.
83800	6,5	3,0	0,045

## Schale, eckig „APART“

bowl, square  
cuenco, cuadrado  
bol, carré



	cm	↑ cm	litr.
83808	6,6 x 6,6	3,0	0,05
83810	10 x 10	4,5	0,17
83812	15 x 15	6,5	0,5
83814	20 x 20	9,0	1,6
83816	25 x 25	9,0	2,6
83818	25 x 25	12,5	3,8
83820	30 x 30	12,5	4,5



## GN 2/4 Schale „APART“

GN 2/4 bowl  
GN 2/4 cuenco  
GN 2/4 bol



	cm	↑ cm	GN	litr.
83826	53,0 x 16,2	6,5	2/4	3,0



Schale „GLOBAL BUFFET“

bowl  
cuenco  
bol



	cm	↑ cm	ltr.	Farbe / Colour
83785	32,5 x 32,5	12,0	3,0	White
83786	35,0 x 35,0	12,5	3,5	White
83787	40,0 x 40,0	13,5	5,0	White
	cm	↑ cm	ltr.	Farbe / Colour
84785	32,5 x 32,5	12,0	3,0	Black
84786	35,0 x 35,0	12,5	3,5	Black
84787	40,0 x 40,0	13,5	5,0	Black



Schale „GLOBAL BUFFET“

bowl  
cuenco  
bol



	cm	↑ cm	ltr.	Farbe / Colour
84464	35,5 x 31,5	14,0	2,5	White
84466	46,0 x 40,0	18,5	5,5	White



Schale „GLOBAL BUFFET“

bowl  
cuenco  
bol



	cm	↑ cm	ltr.	Farbe / Colour
84462	44 x 25	20	3,3	White



Schale „GLOBAL BUFFET“

bowl  
cuenco  
bol



	cm	↑ cm	ltr.	Farbe / Colour
83799	25,5 x 25,5	13,0	3,0	White
83788	32,0 x 32,0	16,5	4,5	White
83789	35,0 x 35,0	17,0	6,0	White
83790	40,0 x 40,0	17,5	8,0	White
	cm	↑ cm	ltr.	Farbe / Colour
83779	25,5 x 25,5	13,0	3,0	Black
84788	32,0 x 32,0	16,5	4,5	Black
84789	35,0 x 35,0	17,0	6,0	Black
84790	40,0 x 40,0	17,5	8,0	Black



Schale „GLOBAL BUFFET“

bowl  
cuenco  
bol



die Melaminschale wirkt optisch wie der Naturstein Granit  
the melamine bowl looks visually as made of natural granit stone  
el cuenco de melamina parece estar hecho de granito natural  
le bol de mélamine donne une impression visuelle de granit naturel

	cm	↑ cm	ltr.	Farbe / Colour
84387	36 x 36	11	3,5	Black

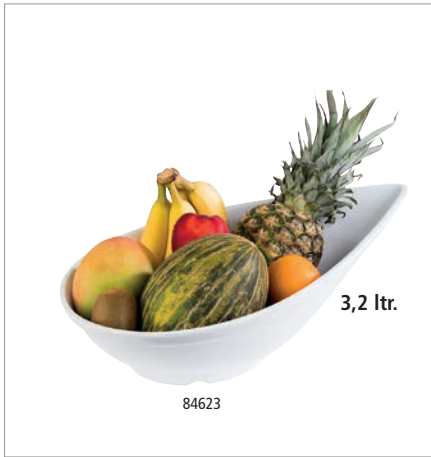

Schale „GLOBAL BUFFET“

bowl  
cuenco  
bol



	cm	↑ cm	ltr.	Farbe / Colour
84622	42 x 27	14	2,2	_____
84623	50 x 32	17	3,2	_____



Schale „LEAF“

bowl  
cuenco  
bol



	cm	↑ cm	ltr.	Farbe / Colour
84200	42 x 19,5	6,5	1,0	_____
84202	50 x 23,0	7,5	1,5	_____



Schale „BIG WAVE“

bowl  
cuenco  
bol



	cm	↑ cm	ltr.	Farbe / Colour
83587	33 x 24	8,5	1	_____



Etagère „CASUAL“

etagère  
expositor  
présentoir



**inklusive Edelstahl-Schild, beschriftbar**  
including stainless steel sign, inscribable  
placa de acero inoxidable incluida, rotulable  
étiquette en acier inox incluse, inscriptible

	Ø cm	↑ cm	
34248	31 - 41 - 51	55	3-stufig / 3-tier 3 niveles / 3 étages
34247	31 - 41	35	2-stufig / 2-tier 2 niveles / 2 étages

# FLYING BUFFET



## Fingerfood-Teller „FLYING BUFFET“

fingerfood plate  
plato para el aperitivo  
assiette pour apéritif



	cm	↑ cm	Farbe / Colour
83878	9,5 x 9,5	1,5 / 3,5	White
83879	9,5 x 9,5	1,5 / 3,5	Black



## Schale „FLOAT“

bowl  
cuenco  
bol



	cm	↑ cm	Farbe / Colour
83912	9 x 9	4,5	White
83913	9 x 9	4,5	Black



## GN Tablett „APART“

GN tray  
GN bandeja  
GN plateau



	cm	↑ cm	GN
83828	53 x 32,5	2,5	1/1



## GN Edelstahl Tablett „FRAMES“

GN stainless steel platter  
GN bandeja de acero inoxidable  
GN plateau en acier inox



	cm	GN
11119	53 x 32,5	1/1

# CASCADE



Schale „CASCADE“  
bowl  
cuenco  
bol



	cm	↑ cm	GN	ltr.
83963	28,5 x 25,5	7,5		2,90
83960	32,5 x 26,5	7,5	1/2	3,65
83962	26,5 x 16,2	7,5	1/4	1,50



Tablett „CASCADE“  
tray  
bandeja  
plateau



	cm	↑ cm	GN	fits to
83964	28,5 x 25,5	2,4		83963
83965	32,5 x 26,5	2,4	1/2	83960
83967	26,5 x 16,2	2,4	1/4	83962



**Tablett kann als Deckel eingesetzt werden!**  
Tray is also useable as a cover!  
¡La bandeja se puede usar como tapa!  
Le plat s'utilise aussi comme couvercle!





Gastronorm - Außenmaße Gastronorm - size Gastronorm - medidas exteriores Gastronorme - Gastronorme dimensions extérieures



**GN 2/4 Schale „CASCADE“**

GN 2/4 bowl  
GN 2/4 cuenco  
GN 2/4 bol



	cm	↑ cm	GN	ltr.
83961	53 x 16,2	7,5	2/4	3,65



**GN 2/4 Tablett „CASCADE“**

GN 2/4 tray  
GN 2/4 bandeja  
GN 2/4 plateau



	cm	↑ cm	GN	fits to
83966	53 x 16,2	2,4	2/4	83961



# FLOAT



- Ideal für den Thekenbereich
- stapelbar mit Löffel und Deckel
- Schalenboden fixiert sich auf dem Deckel
- rutschfest (Antirutschfüßchen)
  
- ideal for the counter area
- stackable with spoon and lid
- the bottom of the bowl is fixed on the lid
- non-slip (with non-slip feet)
  
- idéal pour l'aire de comptoir
- empilable avec cuillère et couvercle
- le fond du bol se fixe sur le couvercle
- antidérapant (avec pieds antidérapants)



## Schale „FLOAT“

bowl  
cuenco  
bol



	Ø cm	↑ cm	ltr.	Farbe / Colour
83900	5,5	3,0	0,03	White
83902	9,0	4,5	0,15	White
83904	13,0	6,5	0,45	White
83906	15,0	7,5	0,70	White
83908	20,5	10,0	1,90	White
	Ø cm	↑ cm	ltr.	Farbe / Colour
83901	5,5	3,0	0,03	Black
83903	9,0	4,5	0,15	Black
83905	13,0	6,5	0,45	Black
83907	15,0	7,5	0,70	Black
83909	20,5	10,0	1,90	Black



Schale „FLOAT“

bowl  
cuenco  
bol



	cm	↑ cm	ltr.	Farbe / Colour
83910	5,5 x 5,5	3,0	0,03	White
83912	9,0 x 9,0	4,5	0,16	White
83914	12,5 x 12,5	6,0	0,50	White
83916	19,0 x 19,0	9,5	1,90	White
83918	25,0 x 25,0	12,0	4,70	White
	cm	↑ cm	ltr.	Farbe / Colour
83911	5,5 x 5,5	3,0	0,03	Black
83913	9,0 x 9,0	4,5	0,16	Black
83915	12,5 x 12,5	6,0	0,50	Black
83917	19,0 x 19,0	9,5	1,90	Black
83919	25,0 x 25,0	12,0	4,70	Black



GN Tablett „FLOAT“

GN tray  
GN bandeja  
GN plateau



	cm	↑ cm	GN	Farbe / Colour
83923	53,0 x 32,5	3	1/1	White
83925	32,5 x 26,5	3	1/2	White
	cm	↑ cm	GN	Farbe / Colour
83924	53,0 x 32,5	3	1/1	Black
83926	32,5 x 26,5	3	1/2	Black



Deckel „FLOAT“ mit Löffelaussparung

cover, with notched for spoons  
tapa, con espacio para la cuchara  
couverture, avec encoche pour la louche



	Ø cm	↑ cm	fits to
83920	20,5	1,3	83908, 83909



Deckel „FLOAT“ mit Löffelaussparung

cover, with notched for spoons  
tapa, con espacio para la cuchara  
couverture, avec encoche pour la louche



	cm	↑ cm	fits to
83921	19 x 19	1,3	83916, 83917
83922	25 x 25	1,3	83918, 83919

# PURE



83401

83479

Tablett „PURE“  
tray  
bandeja  
plateau



	cm	↑ cm	GN	Farbe / Colour
83401	53,0 x 32,5	3	1/1	White
83588	35,4 x 32,5	3	2/3	White
83433	53,0 x 16,2	3	2/4	White
83480	32,5 x 26,5	3	1/2	White
83481	32,5 x 17,6	3	1/3	White
83482	26,5 x 16,2	3	1/4	White
83882	65,0 x 26,5	3		White
83597	40,0 x 30,0	3	Bäcker-Maß	White
83598	60,0 x 20,0	3	Bäcker-Maß	White
83599	60,0 x 40,0	3	Bäcker-Maß	White
	cm	↑ cm	GN	Farbe / Colour
83479	53,0 x 32,5	3	1/1	Black
83589	35,4 x 32,5	3	2/3	Black
83434	53,0 x 16,2	3	2/4	Black
83490	32,5 x 26,5	3	1/2	Black
83491	32,5 x 17,6	3	1/3	Black
83492	26,5 x 16,2	3	1/4	Black
83592	40,0 x 30,0	3	Bäcker-Maß	Black
83593	60,0 x 20,0	3	Bäcker-Maß	Black
83594	60,0 x 40,0	3	Bäcker-Maß	Black



**Tablett „PURE“**

tray  
bandeja  
plateau



	cm	↑ cm	Farbe / Colour
83625	31,0 x 10,5	2	
83403	35,5 x 18,0	3	
83417	30,0 x 21,0	3	
83402	53,0 x 18,0	3	

	cm	↑ cm	Farbe / Colour
83483	53 x 18	3	



**Tablett „PURE COLOR“**

tray  
bandeja  
plateau



	cm	↑ cm	GN	Farbe / Colour
83560	53,0 x 32,5	3	1/1	
83562	32,5 x 26,5	3	1/2	
83561	53,0 x 32,5	3	1/1	
83563	32,5 x 26,5	3	1/2	



**Tablett quadratisch „PURE“**

tray square  
bandeja cuadrada  
plateau carré



	cm	↑ cm	Farbe / Colour
83418	18,0 x 18,0	3	
83407	21,0 x 21,0	3	
83406	26,5 x 26,5	3	
83405	37,0 x 37,0	3	
83404	51,0 x 51,0	3	

	cm	↑ cm	Farbe / Colour
83400	51 x 51	3	



**Tablett / Teller „PURE“**

tray / plate  
bandeja / plato  
plateau / assiette



	Ø cm	↑ cm	Farbe / Colour
83884	31	2,5	
83869	38	2,5	
83886	41	2,5	
83484	51	2,5	



Schale „PURE“

bowl  
cuenco  
bol



	Ø cm	↑ cm	ltr.	Farbe / Colour
83450	5,5	4,0	0,02	White
83419	9,0	4,5	0,09	White
83453	13,0	6,5	0,30	White
83455	15,0	7,5	0,45	White
83415	20,0	10,5	1,25	White
	Ø cm	↑ cm	ltr.	Farbe / Colour
83451	5,5	4,0	0,02	Black
83452	9,0	4,5	0,09	Black
83454	13,0	6,5	0,30	Black
83456	15,0	7,5	0,45	Black
83457	20,0	10,5	1,25	Black



Teller, rund „CASUAL“

plate, round  
plato, redondo  
assiette, ronde



	Ø cm	↑ cm
83500	22,5	2,5
83514	26,5	2,5



0,05 ltr. - 8,0 ltr.

Schale „PURE COLOR“

bowl  
cuenco  
bol



	cm	↑ cm	ltr.	Farbe / Colour
84424	6,5 x 6,5	3,0	0,05	White
83414	9,0 x 9,0	4,0	0,14	White
83410	12,5 x 12,5	6,5	0,40	White
83409	19,0 x 19,0	9,0	1,50	White
83408	25,0 x 25,0	12,0	3,80	White
84425	32,0 x 32,0	14,0	8,0	White
	cm	↑ cm	ltr.	Farbe / Colour
84426	6,5 x 6,5	3,0	0,05	Black
83466	9,0 x 9,0	4,0	0,14	Black
83467	12,5 x 12,5	6,5	0,40	Black
83468	19,0 x 19,0	9,0	1,50	Black
83469	25,0 x 25,0	12,0	3,80	Black
84427	32,0 x 32,0	14,0	8,0	Black
	cm	↑ cm	ltr.	Farbe / Colour
83568	9,0 x 9,0	4,0	0,14	Grey
83570	12,5 x 12,5	6,5	0,40	Grey
83572	19,0 x 19,0	9,0	1,50	Grey
83574	25,0 x 25,0	12,0	3,80	Grey
	cm	↑ cm	ltr.	Farbe / Colour
83569	9,0 x 9,0	4,0	0,14	Olive Green
83571	12,5 x 12,5	6,5	0,40	Olive Green
83573	19,0 x 19,0	9,0	1,50	Olive Green
83575	25,0 x 25,0	12,0	3,80	Olive Green



Schale „PURE BICOLOR“

bowl  
cuenco  
bol



	cm	↑ cm	ltr.	Farbe / Colour
84414	9,0 x 9,0	4,0	0,14	
84410	12,5 x 12,5	6,5	0,40	
84409	19,0 x 19,0	9,0	1,50	
84408	25,0 x 25,0	12,0	3,80	

	cm	↑ cm	ltr.	Farbe / Colour
84420	9,0 x 9,0	4,0	0,14	
84421	12,5 x 12,5	6,5	0,40	
84422	19,0 x 19,0	9,0	1,50	
84423	25,0 x 25,0	12,0	3,80	

	cm	↑ cm	ltr.	Farbe / Colour
84415	9,0 x 9,0	4,0	0,14	
84416	12,5 x 12,5	6,5	0,40	
84417	19,0 x 19,0	9,0	1,50	
84418	25,0 x 25,0	12,0	3,80	



Schale „SLATE“

bowl  
cuenco  
bol



	cm	↑ cm	ltr.
84244	19 x 19	9	1,5
84245	25 x 25	12	3,8

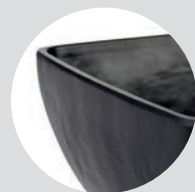

1:1 Oberflächenansicht  
1:1 structural view



Deckel „PURE“ mit Löffelaussparung

cover with notched for spoons  
tapa con espacio para la cuchara  
couverture avec encoche pour la louche



	cm	↑ cm	fits to
83600	19 x 19	1,5	84409, 84417, 84422, 83409, 83468, 83572, 83573
83601	25 x 25	1,5	84408, 84418, 84423, 84430, 83575, 83574, 83469, 83408
83602	32 x 32	1,5	84425, 84427

## Buffet & Tableware Melamin



### Schale „PURE“

bowl  
cuenco  
bol



	cm	↑ cm	ltr.
83497	22,5 x 15,5	7,5	0,80
83498	38,5 x 15,5	7,5	1,50
83499	51,0 x 15,5	7,5	2,40



### Tablett „SLATE“

tray  
bandeja  
plateau



	cm	↑ cm
84960	28 x 17,5	2,5
84961	Ø 28	2,5



### GN Tablett „PURE GRANIT“

GN tray  
GN bandeja  
GN plateau



	cm	↑ cm	GN
84440	53,0 x 32,5	3	1/1
84441	32,5 x 26,5	3	1/2



### Menage „PURE“

menage  
conjunto aperitivo  
set apéritif



4-teilig: 1 Ständer, Edelstahl matt poliert + 3 Melamin-Schalen, weiß (Nr. 83419)

4 pcs. set: 1 stainless stand satin polished finish + 3 white bowls (No. 83419)

set de 4: 1 soporte, acero inoxidable pulido mate + 3 cuencos de melamina blancos (ref. 83419)

set de 4: 1 support, acier inox poli mat + 3 bols de mélamine blancs (ref. 83419)

	cm	↑ cm
09924	14 x 14	16



### Menage „PURE“

menage  
conjunto aperitivo  
set apéritif



5-teilig: 1 Ständer, Edelstahl matt poliert + 4 Melamin-Schalen, weiß (Nr. 83414)

5 pcs. set: 1 stainless stand satin polished finish + 4 square white bowls (No. 83414)

set de 5: 1 soporte, acero inoxidable pulido mate + 4 cuencos de melamina blancos (ref. 83414)

set de 5: 1 support, acier inox poli mat + 4 bols de mélamine blancs (ref. 83414)

	cm	↑ cm
09923	17 x 17	16





**GN Tablett „FRAMES“**

GN tray  
GN bandeja  
GN plateau



	cm	↑ cm	GN
84046	53,0 x 32,5	2	1/1
84047	32,5 x 26,5	2	1/2
84048	32,5 x 17,6	2	1/3



**Schale / Pastateller „PURE“**

bowl / pasta plate  
cuenco / plato para pasta  
bol / assiette creuse



	Ø cm	↑ cm	ltr.	Farbe / Colour
83412	32,0	7,5	1,5	White
83411	45,5	9,0	1,7	White



**Tablett „MADE FOR PURE“**

tray  
bandeja  
plateau



Edelstahl matt poliert, passend für Melamin-Schalen  
stainless steel satin polished finish, for melamin bowls  
acero inoxidable pulido mate, apta para cuencos de melamina  
acier inox poli mat, pour bols de mélamine

	cm	
30120	20 x 11	für 2 Schalen / for 2 bowls para 2 cuencos / pour 2 bols
30121	29 x 20	für 6 Schalen / for 6 bowls para 6 cuencos / pour 6 bols

**Schale „PURE COLOR“ / bowl / cuenco / bol**

	cm	↑ cm	ltr.	Farbe / Colour
83414	9 x 9	4	0,14	White
83466	9 x 9	4	0,14	Black
83568	9 x 9	4	0,14	
83569	9 x 9	4	0,14	

**Schale „PURE BICOLOR“ / bowl / cuenco / bol**

	cm	↑ cm	ltr.	Farbe / Colour
84414	9 x 9	4	0,14	Black/White
84415	9 x 9	4	0,14	Green/White
84420	9 x 9	4	0,14	Grey/White



Blattschale „NATURAL COLLECTION“  
leaf  
fuente en forma de hoja  
plateau feuille



	cm	↑ cm	Farbe / Colour
84083	40 x 18,5	3,5	White
84086	52 x 25,0	4,0	White
	cm	↑ cm	Farbe / Colour
84085	40 x 18,5	3,5	Green
84088	52 x 25,0	4,0	Green



Palmblattschale „NATURAL COLLECTION“  
palm leaf  
fuente en forma de hoja de palmera  
plateau feuille de palme



	cm	↑ cm	litr.	Farbe / Colour
84080	40 x 18,5	10	1,8	White
84082	40 x 18,5	10	1,8	Green



stapelbar, mit Löffelablage  
stackable, for spoons  
apilable, práctico para cubiertos de servicio  
empilable, pratique pour déposer les couverts



Blattschale „NATURAL COLLECTION“  
leaf  
fuente en forma de hoja  
plateau feuille



	cm	↑ cm	Farbe / Colour
83864	34,5 x 8	2,5	White
83862	34,5 x 8	2,5	Green



**Tablett „PINEAPPLE“**

tray  
bandeja  
plateau



	cm	↑ cm	Farbe / Colour
84624	30 x 17	2,5	White



**Palmblattschale „NATURAL COLLECTION“**

palm leaf  
fuente en forma de hoja de palmera  
plateau feuille de palme



	Ø cm	↑ cm	ltr.	Farbe / Colour
83447	30	10,0	1,5	White
83896	35	12,5	4,5	White
	Ø cm	↑ cm	ltr.	Farbe / Colour
83449	30	10,0	1,5	Green
83894	35	12,5	4,5	Green



**Blattschale „NATURAL COLLECTION“**

leaf  
fuente en forma de hoja  
plateau feuille



	cm	↑ cm	Farbe / Colour
83435	36 x 16	3,0	White
83438	45 x 24	3,0	White
83441	53 x 29	3,5	White
	cm	↑ cm	Farbe / Colour
83437	36 x 16	3,0	Green
83440	45 x 24	3,0	Green
83443	53 x 29	3,5	Green



**Palmblattschale „NATURAL COLLECTION“**

palm leaf  
fuente en forma de hoja de palmera  
plateau feuille de palme



	cm	↑ cm	Farbe / Colour
83865	27 x 27	4,5	Green
83446	35 x 34	4,5	Green



**Schale, oval „CLASSIC WAVE“**

owl, oval  
cuenco, ovalada  
plateau ovale



	cm	↑ cm	ltr.	Farbe / Colour
83875	27 x 17	4,0	0,80	White
83876	34 x 21	4,5	1,30	White
83877	47 x 29	5,0	3,20	White



NEW

# ENAMEL LOOK

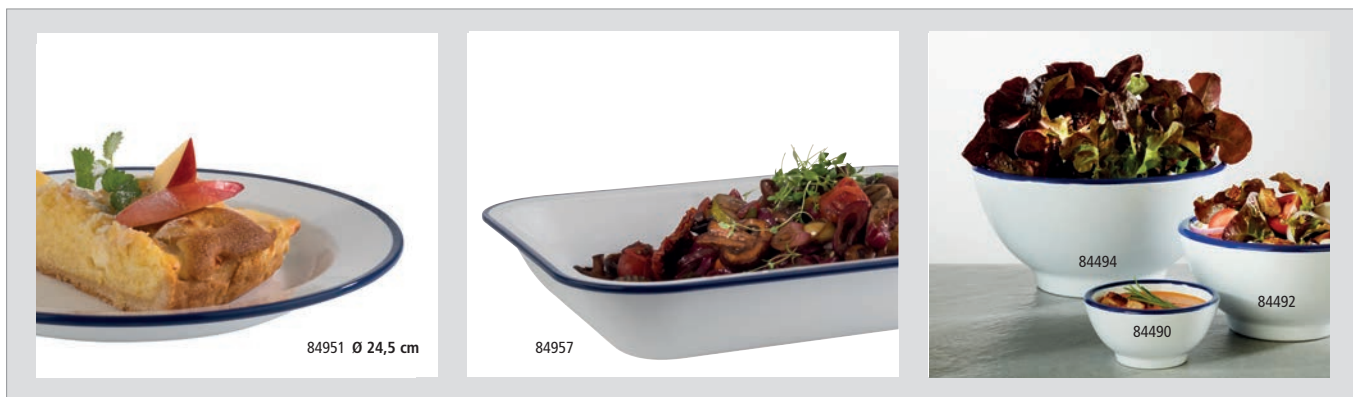

## Suppenteller „ENAMEL LOOK“

soup plate  
plato hondo  
assiette creuse



	Ø cm	↑ cm	Farbe / Colour
84952	19,0	3	
84953	22,5	4	
84954	24,5	4	



## Schale „ENAMEL LOOK“

bowl  
cuenco  
bol



	Ø cm	↑ cm	ltr.	Farbe / Colour
84490	5,5	4,0	0,02	
84491	9,5	4,5	0,09	
84492	13,0	6,5	0,30	
84493	15,0	7,5	0,45	
84494	20,0	10,5	1,25	



Schale „ENAMEL LOOK“

bowl  
cuenco  
bol



	cm	↑ cm	ltr.	Farbe / Colour
84955	15,5 x 11,5	3,5	0,25	
84956	17,5 x 13,0	4,5	0,30	

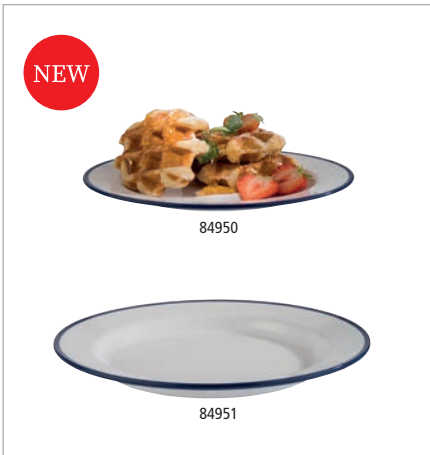

Teller „ENAMEL LOOK“

plate  
plato  
assiette



	Ø cm	↑ cm	Farbe / Colour
84950	20,5	2,0	
84951	24,5	2,5	



Schale „ENAMEL LOOK“

bowl  
cuenco  
bol



	cm	↑ cm	ltr.	Farbe / Colour
84958	15,0 x 11,5	6,5	0,30	
84959	21,5 x 16,5	9,5	1,00	



Schale „ENAMEL LOOK“

bowl  
cuenco  
bol



	cm	↑ cm	ltr.	Farbe / Colour
84957	29,0 x 23,5	5	1,5	



# CASUAL



## Schälchen „CASUAL MINI“

bowl  
cuenco  
bol mini



	cm	↑ cm	ltr.	Farbe / Colour
83880	6,0	2,5	0,02	White
83881	7,5	3,5	0,05	White



## Schale „CASUAL MAXI“

bowl  
cuenco  
bol



	Ø cm	↑ cm	ltr.	Farbe / Colour
83696	10	4,5	0,15	White
83698	12	5,5	0,25	White
83700	14	6,5	0,50	White
83704	20	9,2	1,80	White
83702	23	10,5	2,50	White
.....				
	Ø cm	↑ cm	ltr.	Farbe / Colour
83697	10	4,5	0,15	Black
83699	12	5,5	0,25	Black
83701	14	6,5	0,50	Black
83705	20	9,2	1,80	Black
83703	23	10,5	2,50	Black

Deckel „FLOAT“ mit Löffelaussparung / cover, with notched for spoons / tapa, con espacio para la cuchara / couvercle, avec encoche pour la louche

	Ø cm	↑ cm	fits to
83920	20,5	1,3	83704, 83705



## Dip-Schälchen „CASUAL“

dip bowl  
cuenco para dip  
ramequin



	Ø cm	↑ cm	ltr.	Farbe / Colour	VE / unit
83780	6,0	3,7	0,04	White	24
83781	7,0	3,7	0,05	White	24
83782	7,8	4,0	0,08	White	24
83783	8,5	4,5	0,11	White	24
83784	9,8	4,5	0,14	White	12
83798	6,0	3,7	0,04	Black	24
83777	6,0	3,5	0,03	Terracotta	24



Schale „SCANTIC“

bowl  
cuenco  
bol



	cm	↑ cm	ltr.
84221	26,5 x 10,5	6,5	1,0
84222	53,0 x 10,5	6,5	2,0



Schale „ORGANIC“

bowl  
cuenco  
bol



	cm	↑ cm	ltr.	Farbe / Colour
84235	32,5 x 17	5,5	1,0	White
84236	50,0 x 26	6,5	3,5	White



Schale „CASUAL“

bowl  
cuenco  
bol



	Ø cm	↑ cm	ltr.
84215	10	6,5 / 8,5	0,2
84216	12	7,5 / 9,5	0,3



Schale „TIERRA“

bowl  
cuenco  
bol



	Ø cm	↑ cm	ltr.	Farbe / Colour
84295	10	7	0,13	White



Dipschale „CASUAL“

dip tray  
bandeja para dips  
plateau pour dips



	cm	↑ cm
84220	29 x 9	3

**NEW** CLASSIC



**Servier- und Tortenplatte „CLASSIC“**

cake stand  
porta pasteles  
présentoir à gâteaux



**Rand fixiert die Haube**  
carved edge fixes the cover  
ranura para fijar bien la campana  
bord rainuré pour maintenir ferme la cloche

	Ø cm	↑ cm
85049	21,5	9
85050	21,5	17
85051	30,5	9
85052	30,5	17
85053	37,5	9
85054	37,5	17

**Frischhalte- Haube / cover / campana / cloche**



	Ø cm	↑ cm	fits to
06519 <b>NEW</b>	21	17	85049, 85050
06520	30	22	85051, 85052
06521 <b>NEW</b>	36	27	85053, 85054

**Frischhalte- Haube / cover / campana / cloche**



	Ø cm	↑ cm	fits to
06512	30	11,5	85051, 85052





**Torten- / Konditorplatte**

cake stand  
soporte para pastel  
présentoir à gâteaux

Rand fixiert die Haube, mit Antirutsch-Füßchen

carved edge fixes the cover, with non-slip feet

ranura para fijar bien la campana, con pies antideslizantes

bord rainuré pour maintenir ferme la cloche, avec pieds antidérapants



	Ø cm	↑ cm	Farbe / Colour
00468	31	3,5	
00469	31	3,5	



**Torten- / Konditorplatte**

cake stand  
soporte para pastel  
présentoir à gâteaux

Rand fixiert die Haube, mit Antirutsch-Füßchen

carved edge fixes the cover, with non-slip feet

ranura para fijar bien la campana, con pies antideslizantes

bord rainuré pour maintenir ferme la cloche, avec pieds antidérapants



	Ø cm	↑ cm
85044	21,5	2,5
00468	31,0	3,5
85045	37,5	4,0

**Frischhalte- Haube / cover / campana / cloche**



	Ø cm	↑ cm	fits to
06519 <b>NEW</b>	21	17	85044
06520	30	22	00468
06521 <b>NEW</b>	36	27	85045



**Servier- und Tortenplatte „CASUAL“**

cake plate  
porta pasteles  
présentoir à gâteaux



	Ø cm	↑ cm
83890	31	8
83891	31	16



**Servier- und Tortenplatte „CASUAL“**

cake plate  
porta pasteles  
présentoir à gâteaux



	cm	↑ cm
83892	31 x 31	8
83893	31 x 31	16

## Buffet & Tableware Melamin



### Tablett / Teller „PURE“

tray / plate  
bandeja / plato  
plateau / assiette



	Ø cm	↑ cm	Farbe / Colour
83869	38	2,5	_____

### Rolltophaube / rolltop cover / campana abatible / cloche basculante

	Ø cm	↑ cm	
18388	38	20	mit verchromtem Kugelgriff / with chrome plated handle con pomo cromado / avec bouton chromé



### Frischhalte-Haube

cover  
campana  
cloche



	Ø cm	↑ cm	
06510	30	11,5	
06512	30	11,5	mit verchromtem Griff / with chrom plated handle con botón cromado / avec bouton chromé



### Schale „BALANCE“

bowl  
cuenco  
bol



	Ø cm	↑ cm	ltr.	Farbe / Colour
84040	14,5	9,0	0,4	_____
84041	21,0	13,0	1,5	_____
84042	24,5	15,0	2,5	_____
84043	30,0	19,5	5,0	_____

	Ø cm	↑ cm	ltr.	Farbe / Colour
85040	14,5	9,0	0,4	_____
85041	21,0	13,0	1,5	_____
85042	24,5	15,0	2,5	_____
85043	30,0	19,5	5,0	_____

### Buffetständer „KING“ / buffet stand / soporte para buffet / présentoir buffet

	Ø cm	↑ cm
03622	15	14
03623	15	21



**Besteckablage „SPOON“**

cutlery rest  
reposa cuchara  
pose-cuillère



	cm	↑ cm	
83801	26 x 10,5	5	



**Besteckablage „BOWL“**

cutlery rest  
reposa cuchara  
pose-cuillère



	cm	↑ cm	ltr.
83803	22,5 x 11	6	0,5



**Besteckablage „SMALL WAVE“**

cutlery rest  
reposa cuchara  
pose-cuillère



	cm	↑ cm	
83897	26 x 13	4,5	



**Teller mit Glashalter „COCKTAIL“**

plate with glass holder  
plato sujeta copas  
assiette porte-verre



eignet sich besonders für Stehempfänge, einhändig nutzbar  
particularly suitable for standing receptions, single-handed use  
para uso en recepciones de pie, facil de usar con sólo una mano  
particulièrement pour des receptions debout, utilisable avec une seule main

	cm	↑ cm	
84620	22 x 14	1,5	
84621	Ø cm	↑ cm	
	19	1,5	



**Kaffeebecher „CASUAL“**

coffee cup  
taza de café  
tasse à café



	Ø cm	↑ cm	ltr.
83513	9,5	10	0,4



**Eierbecher, 4er Set**

egg holder, 4 pcs. set  
huevera, set de 4  
coquetier, set de 4



	Ø cm	↑ cm	pcs.
83851	8	3	4
83848	8,5	2	4

# FINGERFOOD LÖFFEL



**Fingerfood Löffel „HALFTONE“**  
party spoon  
cuchara party  
cuillère party



	∅ cm	↑ cm	Farbe / Colour	VE / unit
84158	5,5	7	■ ■	24



**Fingerfood Löffel „HALFTONE“**  
party spoon  
cuchara party  
cuillère party



	cm	↑ cm	Farbe / Colour	VE / unit
84128	14,5 x 4,5	4,5	■ ■	12



**Fingerfood Löffel „BOAT“**  
party spoon  
cuchara party  
cuillère party



	cm	↑ cm	Farbe / Colour	VE / unit
84140	14,5 x 4,5	4,5	■ ■	32
84141	14,5 x 4,5	4,5	■ ■	32
84142	14,5 x 4,5	4,5	■ ■	12



**Fingerfood Löffel „HONG KONG“**

party spoon  
cuchara party  
cuillère party



	cm	↑ cm	Farbe / Colour	VE / unit
83486	13 x 4,5	4,5		60
83487	13 x 4,5	4,5		60
83424	13 x 4,5	4,5		60
83426	13 x 4,5	4,5		60



**Fingerfood-Löffel „MING HING“**

party spoon  
cuchara party  
cuillère party



	cm	↑ cm	Farbe / Colour	VE / unit
83842	11 x 4,5	4		60
83843	11 x 4,5	4		60



**Fingerfood-Löffel „LEAF“**

party spoon  
cuchara party  
cuillère party



	cm	↑ cm	Farbe / Colour	VE / unit
83889	10 x 4,5	1,5		50
83887	10 x 4,5	1,5		50
83888	10 x 4,5	1,5		50



MINI



84625

84626

84627

Schale „MINI COLOUR“

bowl  
cuenco  
bol



	cm	↑ cm	ltr.	Farbe / Colour	VE / unit
84625	12,5 x 9,0	3,5	0,02		12
84626	12,5 x 9,0	3,5	0,02		12
84627	12,5 x 9,0	3,5	0,02		12

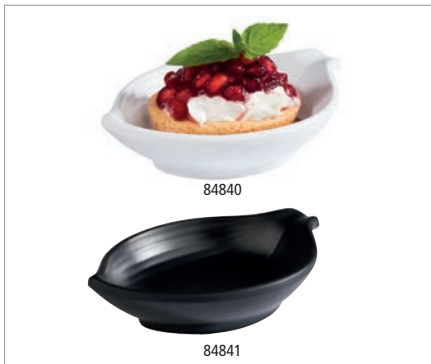

84840

84841

Schale „MINI LEAF“

bowl  
cuenco  
bol



	cm	↑ cm	ltr.	Farbe / Colour	VE / unit
84840	10,5 x 7,5	2,5	0,04		40
84841	10,5 x 7,5	2,5	0,04		40



84842

84843

Schale „MINI LEAF“

bowl  
cuenco  
bol



	cm	↑ cm	ltr.	Farbe / Colour	VE / unit
84842	10,5 x 6,5	4,5	0,06		40
84843	10,5 x 6,5	4,5	0,06		40



84844

84845

Schale „MINI LEAF“

bowl  
cuenco  
bol



	cm	↑ cm	ltr.	Farbe / Colour	VE / unit
84844	14,5 x 6,0	3,0	0,05		40
84845	14,5 x 6,0	3,0	0,05		40



Schale „MINI“

bowl  
cuenco  
bol



	cm	↑ cm	ltr.	Farbe / Colour	VE / unit
84750	8 x 8	3	0,06		24
84760	8 x 8	3	0,06		24

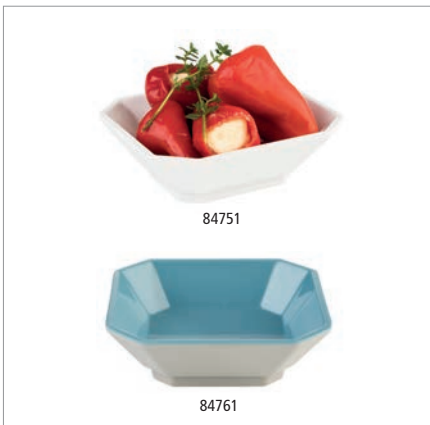

Schale „MINI“

bowl  
cuenco  
bol



	cm	↑ cm	ltr.	Farbe / Colour	VE / unit
84751	9,5 x 9,5	3	0,1		24
84761	9,5 x 9,5	3	0,1		24



Schale „MINI“

bowl  
cuenco  
bol



	cm	↑ cm	ltr.	Farbe / Colour	VE / unit
84752	9,5 x 8	3	0,08		24
84762	9,5 x 8	3	0,08		24



Schale / Schiffchen „MINI“

bowl  
cuenco  
bol



	cm	↑ cm	ltr.	Farbe / Colour	VE / unit
84753	12,5 x 5,5	4	0,06		24
84763	12,5 x 5,5	4	0,06		24



Schale / Schiffchen „MINI“

bowl  
cuenco  
bol



	cm	↑ cm	ltr.	Farbe / Colour	VE / unit
84754	14 x 6,5	4	0,1		24
84764	14 x 6,5	4	0,1		24

## Buffet & Tableware Melamin



### Teller „MINI“

plate  
plato  
assiette



	cm	↑ cm	ltr.	VE / unit
84444	10,5 x 8,5	2,0	0,07	20



### Schale „MINI“

bowl  
cuenco  
bol



	cm	↑ cm	ltr.	VE / unit
84445	10,5 x 6,0	4,0	0,07	20
84446	13,5 x 7,5	3,0	0,07	20
84448	9,5 x 9,0	5,5	0,09	20
84449	13,0 x 12,0	7,5	0,18	20



### Schale „MINI“

bowl  
cuenco  
bol



	Ø cm	↑ cm	ltr.	Farbe / Colour
84775	8,5	2,5	0,07	White
84778	8,5	2,5	0,07	Black
84781	8,5	2,5	0,07	Black



### Schale „MINI“

bowl  
cuenco  
bol



	Ø cm	↑ cm	ltr.	Farbe / Colour
84776	8,5	2,5	0,07	White
84779	8,5	2,5	0,07	Black
84782	8,5	2,5	0,07	Black



### Schale „MINI“

bowl  
cuenco  
bol



	cm	↑ cm	ltr.	Farbe / Colour
84777	9,5 x 5,5	5,5	0,07	White
84780	9,5 x 5,5	5,5	0,07	Black
84783	9,5 x 5,5	5,5	0,07	Black





Schale „MINI“

bowl  
cuenco  
bol



	cm	↑ cm	ltr.	VE / unit
84452	11,5 x 7,5	3,0	0,06	24
84454	11,5 x 6,0	5,5	0,04	24
84456	8,5 x 7,0	6,0	0,07	24
84458	8,0 x 8,0	4,0	0,10	24
84450	7,5 x 7,0	4,5	0,05	24

Schälchen „GOURMET“ / bowl / cuenco / bol

	Ø cm	↑ cm	ltr.
84018	7	6	0,05



Schale „HALFTONE“

bowl  
cuenco  
bol



	Ø cm	↑ cm	ltr.	VE / unit
84217	8,0	4,0	0,1	12
84218	8,5	3,5	0,05	12



Schale „MINI“

bowl  
cuenco  
bol



	cm	↑ cm	ltr.	VE / unit
84460	35 x 4,5	3	0,20	10

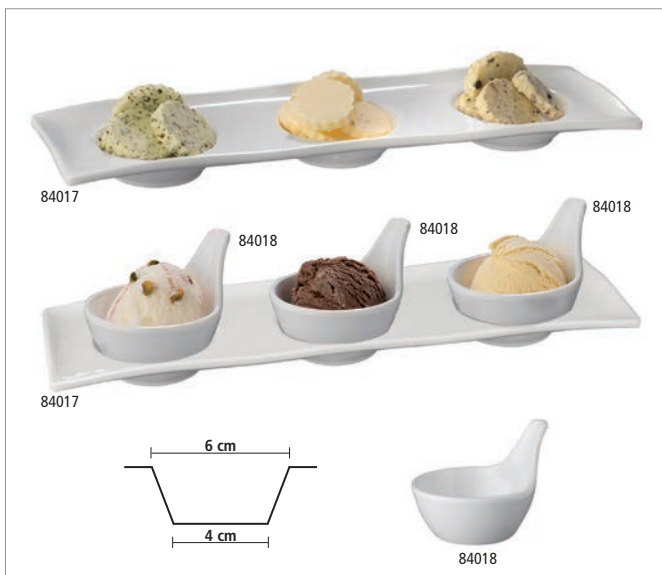

Tablett „GOURMET“

tray  
bandeja  
plateau



mit 3 Absätzen Ø 4 cm  
with 3 holes Ø 4 cm  
con 3 agujeros Ø 4 cm  
avec 3 trous Ø 4 cm

	cm	↑ cm
84017	30,5 x 9,5	2,5

Schälchen „GOURMET“ / bowl / cuenco / bol

	Ø cm	↑ cm	ltr.
84018	7	6	0,05





# Tableware Table Presentation

Tableware  
Table Presentation

**Schalen**  
**Teller**  
**Mühlen**  
**Leuchter**  
**Tischsets**

cuencos  
bandejas  
molinillos  
candelabros  
mantelinas

bowls  
trays  
mills  
candle holders  
placemats

bols  
plateaux  
moulins  
chandeliers  
sets de table



NEW

# Servierkelle - *super trendy*



40680

40681

## Servierkelle „BOB“

serving trowel  
paleta para servir  
truelle de service

EDELSTAHL  
STAINLESS  
INOX

HOLZ  
WOOD



Edelstahl Servierkelle mit schwarzem Holzgriff

stainless steel serving trowel with black wooden handle  
paleta para servir de acero inoxidable con mango de madera negra  
truelle de service en acier inox avec manche en bois noir

	cm	↑ cm	Griff	
40680	23,5 x 15,5	12,5	13,5	stainless steel
40681	23,5 x 15,5	12,5	13,5	■



NEW

40675

40676

## Snackbox „INDUSTRIAL“

snack box  
caja tentempié  
casse-croûte

METALL



Metall, schwarz

metal, black  
metal, negro  
métal, noir

	cm	↑ cm	ltr.
40675	16,5 x 10,5	7,50	0,5
40676	23,0 x 15,5	13,0	2,4



stapelbar  
stackable

NEW



30130



30131



30132



30132



30133



30133

Tablett „VINTAGE“

tray  
bandeja  
plateau



Edelstahl-Look vintage  
stainless steel vintage look  
acero inoxidable look vintage  
acier inox look vintage

	cm	↑ cm
30130	26,0 x 13,5	1,5
30131	34,0 x 18,0	1,5
30132	38,0 x 26,5	1,5
30133	25,5 x 16,0	3,0



passende Schälchen / fitting bowls / cuencos adecuados / bols apropiés

	Ø cm	↑ cm	ltr.
40655	7,5	5,5	0,17
40656	7,5	10,0	0,35



S. 276  
page 276



30130



30132

Servierbeispiel  
serving example

passendes Wachspapier / greaseproof paper squares / papel alimenticio para cucurucho / papier alimentaire pour cornet

	cm	pcs.	
40670	42 x 25	500	Motiv: Zeitung
40671	42 x 25	500	blank
40672	42 x 25	500	Motiv: rote Karos / red
40673	42 x 25	500	Motiv: blaue Karos / blue
40674	30 x 20	500	Motiv: Fast Food / black



40672

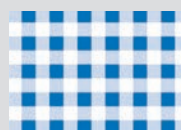

40673



40674

Tablett „TREND“

baking sheet  
bandeja  
plateau



ein Backblech wird zum Serviertablett  
a baking sheet which becomes a serving tray  
una bandeja de hornear que se convierte en una bandeja de servir  
un moule qui devient un plateau de service

	cm	↑ cm
13380	32 x 21,5	2



40672



NEW

# CAST IRON

Die Servierpfännchen aus emailliertem Gußeisen dienen dem portionsweisen Servieren und halten die Speisen warm.

The serving pans made of enameled cast iron are used for serving in portions and for keeping the food warm.

Las fuentes de hierro fundido esmaltado se utilizan para servir en porciones y mantener la comida caliente.

Les plateaux de service en fonte émaillée sont utilisés pour servir en portions et garder les aliments au chaud.

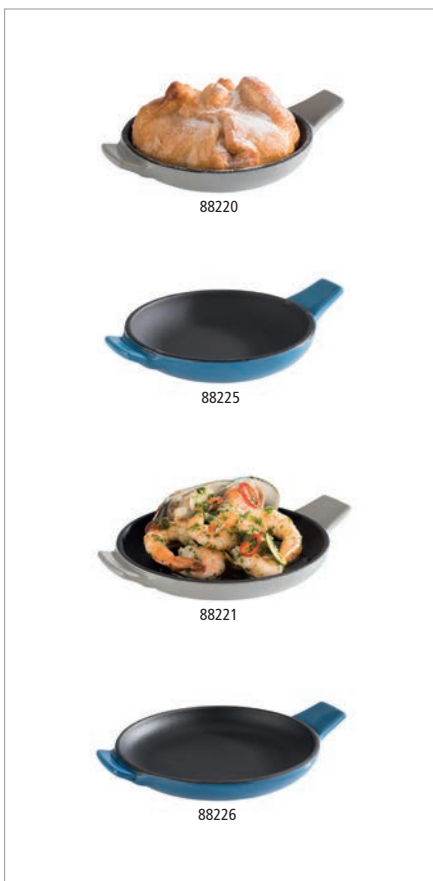

## Servierpfännchen „CAST IRON“ serving pan fuente para servir plat de service



Gusseisen emailliert  
enamelated cast iron  
hierro fundido esmaltado  
fonte émaillée

	Ø cm	↑ cm	Farbe / Colour
88220	10	2	■
88225	10	2	■
88221	13	2	■
88226	13	2	■



stapelbar  
stackable



Servierbeispiel  
serving example



Servierbeispiel  
serving example



Servierpfännchen „CAST IRON“

serving pan  
fuente para servir  
plat de service



Gusseisen emailliert  
enamelled cast iron  
hierro fundido esmaltado  
fonte émaillée

	cm	↑ cm	Farbe / Colour
88222	13 x 13	2	Grey
88227	13 x 13	2	Blue
88223	16 x 13	2	Grey
88228	16 x 13	2	Blue
88224	20 x 13	2	Grey
88229	20 x 13	2	Blue



Präsentationsmöglichkeit  
presentation example

Genusspalette im Kleinformat, Birke / mini serving palett, birch / tabla de servir, formato pequeño, abedul / planche de service, petit format, bouleau



	cm	↑ cm	fits to
00880	20 x 12	3	88223, 88228

Buffetständer „ACACIA“, Akazienholz geölt / buffet stand, acacia wood oiled / soporte para buffet, madera de acacia aceitada / présentoir buffet, bois d'acacia huilé



	cm	↑ cm	GN
15623	53 x 16,2	20	2/4



# SNACKHOLDER



Die Mini-Edestahlkörbchen dienen dem portionsweisen Servieren. Zum originellen Servieren von Beilagen geeignet, aber auch zum Frittieren selbst.

The mini frying baskets are used to present individual portions in an original way, but can still be used to fry.

Las cestas de freir ofrecen una presentación original para el servicio de tapas o raciones individuales de patatas, aperitivos, fritos, etc.

Les paniers à friture offrent une présentation originale pour servir apéritifs, snacks, tapas et autres rations individuelles. Également aptes pour frire.



## Servier-Frittierkorb „SNACKHOLDER“

stainless steel fry baskets  
cestitas inox para el servicio mesa  
paniers inox pour le service sur table



	Ø cm	↑ cm	Griff
40600	8	7,5	9,5
40601	9	8,5	9,0



## Servier-Frittierkorb „SNACKHOLDER“

stainless steel fry baskets  
cestitas inox para el servicio mesa  
paniers inox pour le service sur table



	cm	↑ cm	Griff
40610	21,5 x 10,5	4,5	9,5
40611	26,0 x 13,0	5,0	9,0



## Servier-Frittierkorb „SNACKHOLDER“

stainless steel fry baskets  
cestitas inox para el servicio mesa  
paniers inox pour le service sur table



	cm	↑ cm	Griff
40620	10,0 x 8,5	6,5	9,0
40621	13,0 x 10,5	9,0	13,5



# SNACKHOLDER



Made from PVD coated stainless steel

Die Mini-Edestahlkörbchen dienen dem portionsweisen Servieren. Zum originellen Servieren von Beilagen geeignet, aber auch zum Frittieren selbst.

The mini frying baskets are used to present individual portions in an original way, but can still be used to fry.

Las cestas de freir ofrecen una presentación original para el servicio de tapas o raciones individuales de patatas, aperitivos, fritos, etc.

Les paniers à friture offrent une présentation originale pour servir apéritifs, snacks, tapas et autres rations individuelles. Également aptes pour frire.



40602

## Servier-Frittierkorb „SNACKHOLDER“

stainless steel fry baskets  
cestitas inox para el servicio mesa  
paniers inox pour le service sur table



	Ø cm	↑ cm	Griff	Farbe / Colour
40602	8	7,5	9,5	—
40603	9	8,5	9,0	—



40613

## Servier-Frittierkorb „SNACKHOLDER“

stainless steel fry baskets  
cestitas inox para el servicio mesa  
paniers inox pour le service sur table



	cm	↑ cm	Griff	Farbe / Colour
40612	21,5 x 10,5	4,5	9,5	—
40613	26,0 x 13,0	5	9,5	—



40622

## Servier-Frittierkorb „SNACKHOLDER“

stainless steel fry baskets  
cestitas inox para el servicio mesa  
paniers inox pour le service sur table



	cm	↑ cm	Griff	Farbe / Colour
40622	10,0 x 8,5	6,5	9,0	—
40623	13,0 x 10,5	9,0	13,5	—

## Tableware . Table Presentation



### Snackholder

serving cup  
vaso para servir  
gobelet à apéritif

#### Edelstahl, außen verkupfert

stainless steel, outside copper coated  
acero inoxidable, el exterior está cubierto de cobre  
acier inoxydable, l'extérieur est cuivré



	Ø cm	↑ cm	ltr.	Farbe / Colour	
40616	9,5	8,5 / 11,5	0,45		kupfer / copper
40617	8,5	8,5	0,35		kupfer / copper
40618	8,5	8,5	0,35		gehämmerte Oberfläche / hammered



### Snackholder

serving cup  
vaso para servir  
gobelet à apéritif



	Ø cm	↑ cm	ltr.	
40605	9,5	8,5 / 11,5	0,45	
40606	8,5	8,5	0,35	
40607	8,5	8,5	0,35	gehämmerte Oberfläche / hammered



### Servier- / Saucen-Eimer „SNACKHOLDER“

mini stainless steel bucket  
cubo inox en formato mini  
seau mini inox



	Ø cm	↑ cm	ltr.	pcs.
40630	7	6,5	0,15	4
40631	9	8,5	0,33	1

NEW



40675

### Snackbox „INDUSTRIAL“

snack box  
caja tentempié  
casse-croûte

Metall, schwarz  
metal, black  
metal, negro  
métal, noir



	cm	↑ cm	ltr.
40675	16,5 x 10,5	7,5	0,5
40676	13,0 x 10,5	9,0	2,4



4 pcs. set

### Mini-Milchkanne „SNACKHOLDER“

mini milk can  
lechera en formato mini  
pot à lait mini



	∅ cm	↑ cm	ltr.	pcs.
40640	4,5	5	0,08	4



### Mini-Servierpfanne „SNACKHOLDER“

mini pan  
sartén en formato mini  
poêle à frire mini



	cm	↑ cm	ltr.
40660	14,5 x 9,5	4,5 / 6,5	0,5



40671

40670

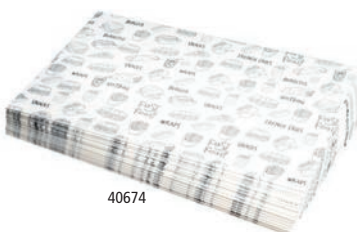

40674

### Wachspapier „SNACKHOLDER“

greaseproof paper squares  
papel alimenticio para cucurucho  
papier alimentaire pour cornet

	cm	pcs.	
40670	42 x 25	500	Motiv: Zeitung
40671	42 x 25	500	blank

	cm	pcs.	
40672	42 x 25	500	Motiv: rote Karos / red
40673	42 x 25	500	Motiv: blaue Karos / blue
40674	30 x 20	500	Motiv: Fast Food / black



40672

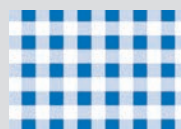

40673



40674

## Tableware . Table Presentation

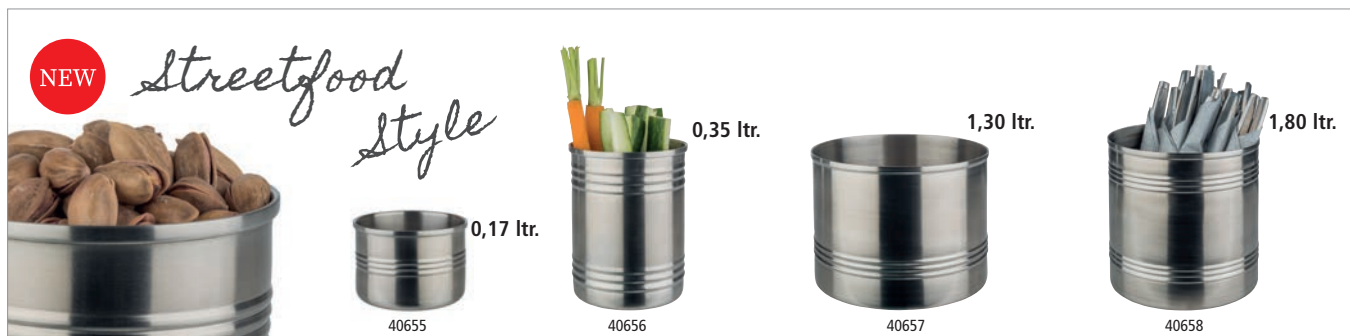

### Snackcan

serving can

bote para aperitivos

boîte pour apéritifs



	∅ cm	↑ cm	ltr.
40655	7,5	5,5	0,17
40656	7,5	10,0	0,35
40657	13,5	10,5	1,30
40658	13,5	14,0	1,80



### Schale

bowl

cuenco

bol



	∅ cm	↑ cm	ltr.
40685	6	3,0	0,05
40686	8	4,5	0,17



### Schale

bowl

cuenco

bol

gehämmerte Oberfläche / hammered surface / superficie martillada / surface martelée



	∅ cm	↑ cm	ltr.
40185	9,5	3	0,15



### Serviertöpfchen

small serving pot

olla pequeña de servir

marmite petite de servir

gehämmerte Oberfläche

hammered surface

superficie martillada

surface martelée



	∅ cm	↑ cm	ltr.	Griff / handle
40186	9,5	5,5	0,30	2,5
40187	13,5	5,0	0,55	3,0
40188	15,5	5,0	0,75	3,0



Schale  
bowl  
cuenco  
bol



gehämmerte Oberfläche  
hammered surface  
superficie martillada  
surface martelée

	cm	↑ cm	ltr.	Farbe / Colour
40690	15,5 x 12,0	5,5	0,7	gold look
40693	23,0 x 15,5	6,0	1,4	gold look



Schale  
bowl  
cuenco  
bol



gehämmerte Oberfläche  
hammered surface  
superficie martillada  
surface martelée

	cm	↑ cm	ltr.	Farbe / Colour
40691	15,5 x 12,0	5,5	0,7	copper look
40694	23,0 x 15,5	6,0	1,4	copper look



Schale  
bowl  
cuenco  
bol



gehämmerte Oberfläche  
hammered surface  
superficie martillada  
surface martelée

	cm	↑ cm	ltr.	Farbe / Colour
40692	15,5 x 12,0	5,5	0,7	gunmetal-look
40695	23,0 x 15,5	6,0	1,4	gunmetal-look

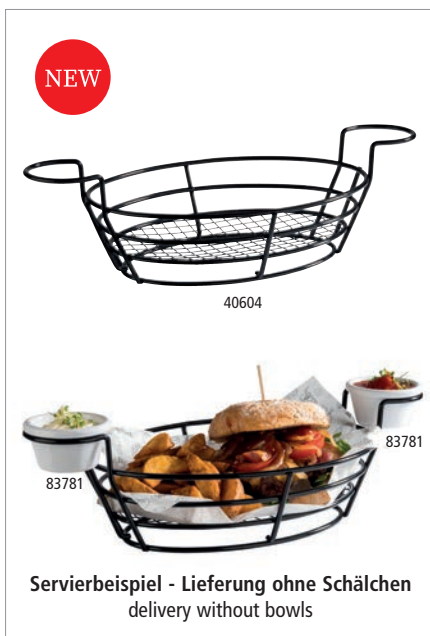

Servierkorb „BURGER & FRIES“  
serving basket  
cesta para servir  
corbeille de service



Servierkorb aus Metall mit 2 Halter für Dipschälchen  
metal serving basket with 2 holders for dip bowls  
cesta de metal para servir con 2 soportes para cuencos para dip  
corbeille de service en métal avec 2 supports pour ramequins

	cm	↑ cm
40604	39,5 x 20	11

passende Schälchen / fitting bowls / cuencos adecuados / bols apropiés



	ø cm	↑ cm	ltr.	VE / unit
83781	7	3,7	0,05	24

Servierbeispiel - Lieferung ohne Schälchen  
delivery without bowls

# ENAMELWARE



40664

## Teller „ENAMELWARE“

plate  
plato  
assiette



	Ø cm	↑ cm	Farbe / Colour	
40664	20	2		flacher Teller
40665	24	2		flacher Teller
40666	26	2		flacher Teller



40662

## Teller „ENAMELWARE“

plate  
plato  
assiette



	Ø cm	↑ cm	Farbe / Colour	
40661	18	3,5		tiefer Teller
40662	22	3,5		tiefer Teller
40663	24	3,5		tiefer Teller



40668

## Schale „ENAMELWARE“

bowl  
cuenco  
bol



	cm	↑ cm	ltr.	Farbe / Colour
40667	16 x 12,0	3,5	0,20	
40668	18 x 13,5	4,0	0,35	



## Schale „ENAMELWARE“

bowl  
cuenco  
bol



	cm	↑ cm	ltr.	Farbe / Colour
40669	28 x 23	4,5	1,9	



**Henkelbecher „ENAMELWARE“**

beaker  
vaso coctelero  
bol mélangeur



	Ø cm	↑ cm	ltr.	Farbe / Colour
40636	7	5	0,10	
40632	9	8	0,35	
40637	10	9	0,50	



**Henkelbecher „ENAMELWARE“**

beaker  
vaso coctelero  
bol mélangeur



	Ø cm	↑ cm	ltr.	Farbe / Colour
40633	9	8	0,35	



**Henkelbecher „ENAMELWARE“**

beaker  
vaso coctelero  
bol mélangeur



	Ø cm	↑ cm	ltr.	Farbe / Colour
40634	9	8	0,35	



**Henkelbecher „ENAMELWARE“**

beaker  
vaso coctelero  
bol mélangeur



	Ø cm	↑ cm	ltr.	Farbe / Colour
40635	9	8	0,35	



**Schale „ENAMELWARE“**

bowl  
cuenco  
bol



	Ø cm	↑ cm	ltr.	Farbe / Colour
40645	7,0	4,5	0,08	
40646	8,0	3,5	0,08	
40638	13,0	6,0	0,50	
40647	16,5	4,5	0,45	



**Weck-Flaschen, 6er Set**

Weck-bottles  
Weck-botellas  
Weck-bouteilles



6 Flaschen + 6 Deckel, ideal zum Servieren von Saft, Smoothie, Dressing und Saucen  
6 bottles + 6 covers, ideal for serving juice, smoothie, dressing and sauces  
6 botellas + 6 tapas, ideal para servir zumo, licuado, aliño y salsas  
6 bouteilles + 6 couvercles, idéal pour servir de jus, smoothie, vinaigrette et sauces

	Ø cm	↑ cm	ltr.	pcs
82307	6	14,5	0,25	6



**Weck-Flaschen, 6er Set**

Weck-bottles  
Weck-botellas  
Weck-bouteilles



6 Flaschen + 6 Deckel, ideal zum Servieren von Saft, Smoothie, Dressing und Saucen  
6 bottles + 6 covers, ideal for serving juice, smoothie, dressing and sauces  
6 botellas + 6 tapas, ideal para servir zumo, licuado, aliño y salsas  
6 bouteilles + 6 couvercles, idéal pour servir de jus, smoothie, vinaigrette et sauces

	Ø cm	↑ cm	ltr.	pcs
82308	6	19	0,5	6



**Weck-Flaschen, 6er Set**

Weck-bottles  
Weck-botellas  
Weck-bouteilles



6 Flaschen + 6 Deckel, ideal zum Servieren von Saft, Smoothie, Dressing und Saucen  
6 bottles + 6 covers, ideal for serving juice, smoothie, dressing and sauces  
6 botellas + 6 tapas, ideal para servir zumo, licuado, aliño y salsas  
6 bouteilles + 6 couvercles, idéal pour servir de jus, smoothie, vinaigrette et sauces

	Ø cm	↑ cm	ltr.	pcs
82309	6	25,5	1,0	6





**Weck-Gläser mit Deckel, 12er Set**

Weck-glasses with lid  
Weck tarros de vidrio con tapa  
Weck verrines avec couvercle



**12 Gläser + 12 Deckel**  
12 glasses + 12 covers  
12 vasos + 12 tapas  
12 verrines + 12 couvercles

	Ø cm	↑ cm	ltr.	pcs
82316	7	8,0	0,22	12



**Weck-Gläser mit Deckel, 12er Set**

Weck-glasses with lid  
Weck tarros de vidrio con tapa  
Weck pots en verre avec couvercle



**12 Gläser + 12 Deckel**  
12 glasses + 12 cover  
12 vasos + 12 tapas  
12 verrines + 12 couvercles

	Ø cm	↑ cm	ltr.	pcs
82345	9	6	0,20	12



**Weck-Gläser mit Deckel, 3er Set**

Weck-glasses with lid, 3 pcs.  
Weck tarros de vidrio con tapa, set de 3  
Weck verrines avec couvercle, set de 3



**3 Gläser + 3 Deckel**  
3 glasses + 3 covers  
3 vasos + 3 tapas  
3 verrines + 3 couvercles

	Ø cm	↑ cm	ltr.	pcs
82346	11	7,5	0,37	3



**Weck-Gläser mit Deckel, 2er Set**

Weck-glasses with lid, 2 pcs.  
Weck tarros de vidrio con tapa, set de 2  
Weck verrines avec couvercle, set de 2



**2 Gläser + 2 Deckel**  
2 glasses + 2 covers  
2 vasos + 2 tapas  
2 verrines + 2 couvercles

	Ø cm	↑ cm	ltr.	pcs
82347	11	11	0,58	2

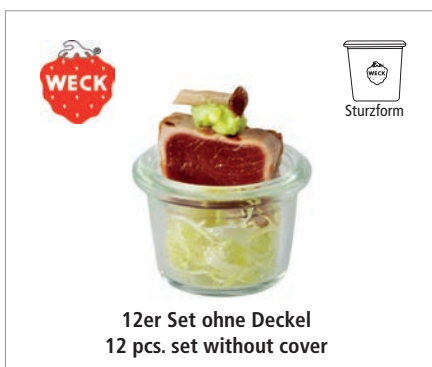

**Gourmetgläser, 12er Set**

gourmet glasses, 12 pcs.  
tarros gourmet, set de 12  
verres gourmet, set de 12



	Ø cm	↑ cm	ltr.	pcs
82359	5	3,5	0,035	12
82370	6	5,5	0,08	12
82371	6	8,0	0,16	12

**12er Set ohne Deckel**  
12 pcs. set without cover



**Weck-Gläser mit Deckel, 12er Set**

Weck-glasses with lid  
Weck tarros de vidrio con tapa  
Weck verrines avec couvercle



**12 Gläser + 12 Deckel**  
12 glasses + 12 covers  
12 vasos + 12 tapas  
12 verrines + 12 couvercles

	Ø cm	↑ cm	ltr.	pcs
82310	6	5,5	0,08	12
82312	6	7,0	0,14	12
82314	6	8,0	0,16	12



**Serviergestell „WECK“**

serving stand  
expositor  
présentoir



**ohne Gläser**  
without glasses  
sin vasos  
sans verrines

	Ø cm	↑ cm	
33246	22	59	12 x Ø 6 cm



**Serviergestell „WECK“**

serving stand  
expositor  
présentoir



**ohne Gläser**  
without glasses  
sin vasos  
sans verrines

	Ø cm	↑ cm	
33247	22	33	6 x Ø 6 cm



### Weck-Frischhaltedeckel, 5er Set

airtight cover, 5 pcs.  
tapa hermética, set de 5  
couvercle hermétique, set de 5



für Rundrandgläser Ø 6 cm, 5er Set

for Ø 6 cm glasses, 5 pcs. set  
para vasos Ø 6 cm, set de 5  
pour verrines Ø 6 cm, set de 5

	Ø cm	pcs
82338	7	5



### 10er Set Gummidichringe

10 pcs. rubber washer  
10 juntas de goma  
10 joints de caoutchouc

für Deckel der Weck-Gläser, im Beutel verpackt

for covers of Weck-glasses  
para las tapas de los tarritos Weck  
pour la fermeture des verrines Weck

	fits to
82318	82307, 82308, 82309, 82310, 82312, 82314, 82316
82394	82345
82395	82346, 82347



### 8er Set Deckel-Klammer für 4 Weck-Gläser

8 pcs. cover clamps for 4 Weck-glasses  
8 abrazaderas para 4 vasitos Weck  
8 agrafes pour 4 verrines Weck



82319



**Topf darf nicht erhitzt werden!**  
Topf ist nicht zum Kochen geeignet!

### Muscheltopf

mussel pot  
mejillonera  
casserole à moules

schwarz emailliertes Stahlblech, mit Edelstahlrand

black enamelled steel, stainless steel rim

hierro esmaltado negro, borde inox

acier émaillé noir, bord inox



	Ø cm	↑ cm	Topf / pot ltr.	Deckel / lid ltr.
00623	13,5	9,0	0,75	0,60
00625	18,0	12,0	2,60	1,40
00626	20,0	13,0	3,30	1,60
00627	24,0	13,5	5,20	2,70

## Tableware . Table Presentation



### Schale „OLIVE“

bowl  
cuenco  
bol

aus geöltem Olivenholz  
oiled olive wood  
de madera de olivo aceitada  
en bois d'olivier huilé



	cm	↑ cm	ltr.
00843	12,0 x 7,5	2,5	0,05
00844	16,5 x 9,5	2,5	0,10



### Schale „OLIVE“

bowl  
cuenco  
bol

aus geöltem Olivenholz  
oiled olive wood  
de madera de olivo aceitada  
en bois d'olivier huilé



	cm	↑ cm	ltr.
00907	13 x 8	6,5	0,20
00908	16 x 9	7,0	0,30



### Servierbrett „OLIVE“

serving board  
tabla de servir  
planche de service

aus geöltem Olivenholz  
oiled olive wood  
de madera de olivo aceitada  
en bois d'olivier huilé



	cm	↑ cm
00905	25,5 x 16,5	1,5
00906	35,0 x 20,5	1,5



### Servierbrett „NARROW“

serving board  
tabla de servir  
planche de service

Akazienholz, mit 3 Vertiefungen Ø 6 cm  
acacia wood, with 3 notches Ø 6 cm  
madera de acacia, con 3 ranuras Ø 6 cm  
bois d'acacia, avec 3 encoches Ø 6 cm



	cm	↑ cm
00878	31 x 11	2



passende Schälchen / fitting bowls / cuencos adecuados / bols apropiés

	Ø cm	↑ cm	ltr.	
40685	6	3	0,05	stainless steel
82316	7	8	0,22	glas

NEW



**Servierbrett „SHARING“**

serving board  
tabla de servir  
planche de service



Servierbrett aus geöltem Akazienholz  
serving board made of oiled acacia wood  
tabla de servir de madera de acacia aceitada  
planche en bois d'acacia huilé

	cm	↑ cm	Griff / handle cm
00887	51,5 x 18	1,5	8,5



00868

**Servierbrett „AKAZIE-SCHIEFER“**

serving board  
tabla de servir  
planche de service

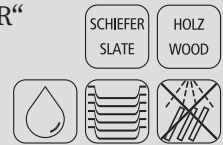

raffiniertes, rustikales Servierbrett  
aus Akazienholz, ausgestattet mit einem Naturschieferstreifen  
zur Kennzeichnung

wood with slate, markable  
madera con pizarra, se puede marcar  
bois avec ardoise, on peut mettre une inscription

	cm	↑ cm
00867	30,5 x 13	1,5
00868	36,5 x 15	1,5
00869	42,0 x 18	1,5



00870



00873



00875

**Servierbrett „OLIVE“**

serving board  
tabla de servir en madera de olivo  
planche de service en bois d'olivier



Servierbrett im Naturschnitt, aus Olivenholz. Jedes Brett wird handgefertigt und geölt mit 19 mm Aufhäng Bohrung. Alle Produkte unterscheiden sich naturbedingt in Form, Maserung und Größe!

Olive Wood is known for its versatility and striking appearance with each piece having its own unique features.

El olivo es conocido por su versatilidad y aspecto espectacular y único en cada pieza. Por su fabricación a mano de forma artesanal, todas las piezas varían en tamaño, forma y acabado, lo que hace de cada una un ejemplar único.

Le bois d'olivier est reconnu pour sa versatilité et son esthétique spectaculaire. De par leur fabrication artisanale à la main, toutes les pièces varient quant à leur taille, forme et finition, de telle sorte que chacune est un exemplaire unique.

	cm	↑ cm	Griff / handle cm
00870	25,0 x 17,0	1,5	
00871	30,0 x 20,5	2,0	
00872	35,0 x 24,0	2,0	
00873	40,0 x 15,0	1,5	11
00874	44,0 x 20,0	2,0	12
00875	19,0 x 12,5	1,5	6
00876	25,0 x 16,0	1,5	8
00877	31,0 x 20,0	1,5	9

## Tableware . Table Presentation

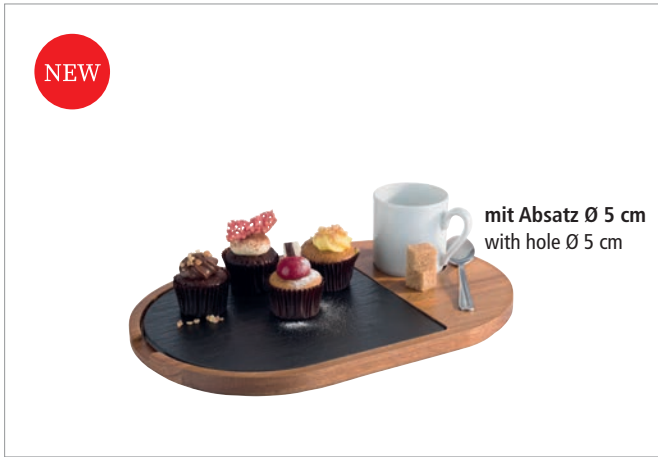

**Servierbrett, 2-tlg.**  
serving board, 2 pcs. set  
tabla de servir, set de 2  
planche de service, set de 2

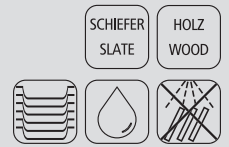

**2-teilig:**  
1 Holzbrett aus Akazienholz + 1 Naturschieferplatte  
1 wood board made of acacia wood + 1 natural slate tray  
1 tabla de madera de acacia + 1 pizarra natural  
1 planche en bois d'acacia + 1 ardoise naturelle

	cm	↑ cm
00814	28 x 17,5	2

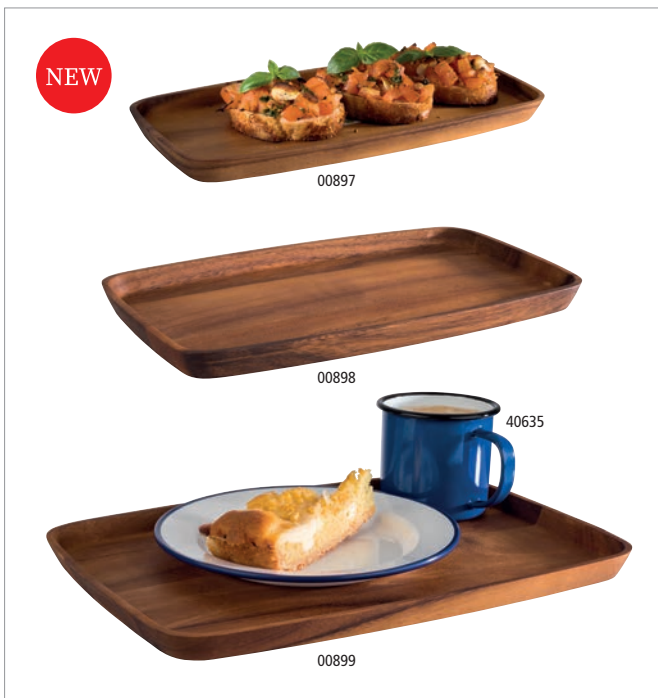

**Servierbrett**  
serving board  
tabla de servir  
planche de service



**Servierbrett aus geöltem Akazienholz**  
serving board made of oiled acacia wood  
tabla de servir de madera de acacia aceitada  
planche en bois avec plateau en bois d'acacia huilé

	cm	↑ cm
00897	30 x 15	2
00898	30 x 18	2
00899	35 x 25	2



**Servierbrett, 2-tlg.**  
serving board, 2 pcs. set  
tabla de servir, set de 2  
planche de service, set de 2

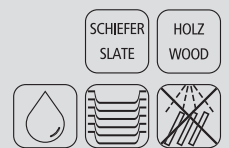

**2-teilig:**  
Ein rustikales Servierbrett aus Akazienholz,  
ausgestattet mit einer Naturschieferplatte  
wood board oiled acacia with a slate tray  
tabla de madera de acacia con una bandeja de pizarra natural  
planche en bois d'acacia avec un plateau en ardoise naturelle

	cm	↑ cm
00810	26 x 18	2
00811	33 x 20	2
00812	40 x 15	2
00813	43 x 12	2

**Präsentationsmöglichkeit**  
presentation example



mit Hängeloch Ø 2 cm / with a handle-hole Ø 2 cm



**Servierbrett „OAK“**

serving board  
tabla de servir  
planche de service



aus geöltem Eichenholz, Safrille, ø 9,5 cm runde Aussparung

made of oiled oak, with juice groove, with hole ø 9.5 cm

de madera de roble aceitada, con ranura para líquidos, con agujero ø 9,5 cm

en bois chêne huilé, avec rigole, avec trou ø 9,5 cm

	cm	↑ cm
00808	37 x 25	2



mit Safrinne / with juice groove



**Holzbox „TABLE“**

woodbox  
caja madera  
base bois



Akazienholz, 3 Fächer (6,5 x 6,5 cm)

acacia wood, 3 compartments (6,5 x 6,5 cm)

madera de acacia, 3 compartimentos (6,5 x 6,5 cm)

bois d'acacia, 3 compartiments (6,5 x 6,5 cm)

	cm	↑ cm	inner size cm
11727	23,5 x 8,5	4,5	6,5 x 6,5 je Fach / each compartment



**Holzbox „VINTAGE“**

woodbox  
caja madera  
base bois



Akazienholz, vintage weiß

acacia wood, vintage white

madera de acacia, blanca vintage

bois d'acacia, blanc vintage

	cm	↑ cm	inner size cm
11725	15 x 9,5	5	12 x 6,5



**Holzbox „TABLE“**

woodbox  
caja madera  
base bois



Akazienholz, natur

acacia wood, nature

madera de acacia, natural

bois d'acacia, naturel

	cm	↑ cm	inner size cm
11726	15 x 9,5	5	12 x 6,5

## Tableware . Table Presentation



### Rindenholzbrett „NATURA“

wood plater  
tabla de madera con corteza  
planche en bois avec écorce



Akazienholz mit Rinde, jedes Brett ein Unikat, vor dem Erstgebrauch mit Speiseöl behandeln  
acacia wood with bark, each board unique, treat with cooking oil before first use  
madera de acacia con corteza, cada tabla un ejemplar único, tartar con aceite de cocina antes del primer uso  
bois d'acacia avec écorce, chaque planche une modèlle unique, traiter avec de l'huile de caisson avant la première utilisation

	cm	↑ cm
00895	26,0 x 24,0	2
00896	30,0 x 28,5	2



### Besteckbehälter „TIN“

cutlery bin  
recipiente  
récipient



Behälter aus Metall mit Tragegriff aus Holz  
container made of metal with wooden handle  
contenedor de metal con asa de madera  
conteneur métallique avec poignée en bois

	cm	↑ cm
00014	24,5 x 12	18,5



### Naturschieferplatte

natural slate tray  
bandeja pizarra natural  
plat ardoise naturelle



mit Absatz Ø 6 cm  
with hole Ø 6 cm  
con agujero Ø 6 cm  
avec trou Ø 6,0 cm

	cm	* mm
00986	25 x 12	6 - 9

passende Gläser:  
82310, 82312, 82314,  
82316



### Naturschieferplatte

natural slate tray  
bandeja pizarra natural  
plat ardoise naturelle



mit 3 Absätzen, Ø 6 cm  
with 3 holes, Ø 6 cm  
con 3 agujeros, Ø 6 cm  
avec 3 trous, Ø 6 cm

	cm	* mm
00987	28 x 10	6 - 9

passende Gläser:  
82310, 82312, 82314,  
82316





**Naturschieferplatte „STARTER“**

natural slate tray  
bandeja de pizarra natural  
plat ardoise naturelle carré



	cm	mm
00937	20 x 10	6 - 9



Weck-Glas 82316

**Naturschieferplatte / Untersetzer**

natural slate tray  
bandeja de pizarra natural  
plateau ardoise naturelle



mit 2 Absätzen Ø 6 cm  
with 2 holes Ø 6 cm  
con 2 agujeros Ø 6 cm  
avec 2 trous Ø 6 cm

	cm	mm
00971	15 x 8	6 - 9



**Naturschieferplatte, 2-teilig**

natural slate tray, 2 pcs. set  
bandeja de pizarra natural y campana  
plateau ardoise naturelle et cloche en verre

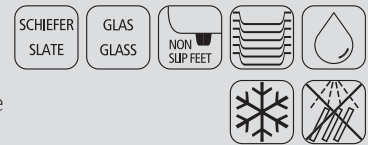

mit Glashaube  
with glass cover  
con tapa de cristal  
avec cloche en verre

	Ø cm	↑ cm	mm
00984	10,5	8	6 - 9



**Naturschieferplatte**

natural slate tray  
bandeja de pizarra natural  
plat ardoise naturelle



	cm	mm
00996	45 x 30	6 - 9



00994

**Naturschieferplatte**

natural slate tray  
bandeja de pizarra natural  
plat ardoise naturelle



	cm	mm
00994	25 x 25	6 - 9
00995	30 x 30	6 - 9



**Konditorplatte**  
 cake stand  
 soporte para pastel  
 présentoir à gâteaux



**matt poliert**  
 satin polished finish  
 acabado efecto satinado  
 poli mat effet satin

	Ø cm	↑ cm
00046	31	3



**Servier- / Tortenplatte**  
 cake stand  
 soporte para pastel  
 présentoir à gâteaux



**Fuß hochglanzpoliert, Platte matt poliert, stabil und sehr standsicher**  
 foot mirror polished finish, plate satin polished finish  
 pie pulido brillante, bandeja pulida mate  
 pied brillant, plateau poli satin mat

	Ø cm	↑ cm
00462	30	11



**Servier- / Tortenplatte**  
 cake stand  
 soporte para pastel  
 présentoir à gâteaux



**matt poliert, drehbar, möbelschonende Moosgummi-Unterseite**  
 satin polished finish, rotating, foam rubber below to save your furniture  
 acabado pulido satinado, giratorio, base revestida de goma para no rallar el mobiliario  
 poli satiné, plateau tournant, revêtement mousse sous le pied pour ne pas rayer les meubles

	Ø cm	↑ cm
00463	30,5	9



**Servier- / Tortenplatte**  
 cake stand  
 soporte para pastel  
 présentoir à gâteaux



**Fuß matt poliert, stabil und sehr standsicher, möbelschonende Moosgummi-Unterseite**  
 foot satin polished finish, foam rubber below to save your furniture  
 pie pulido con efecto satinado, base revestida de goma para no rallar el mobiliario  
 inox poli satin, revêtement mousse sous le pied pour ne pas rayer les meubles

	Ø cm	↑ cm
00464	30	11

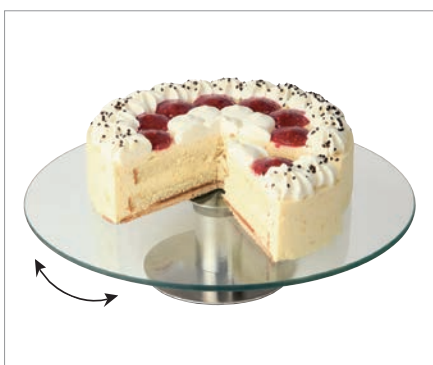

**Servier- / Tortenplatte**  
 cake stand  
 soporte para pastel  
 présentoir à gâteaux



**Fuß matt poliert, drehbar, möbelschonende Moosgummi-Unterseite**  
 foot satin polished finish, rotating, foam rubber below to save your furniture  
 vidrio, pie inox satinado giratorio, base de goma para proteger el mobiliario  
 plateau en verre, pied tournant inox poli satin, revêtement mousse sous le pied anti-rayures

	Ø cm	↑ cm
00444	30	7



**Torten- / Konditorplatte „SLATE“**

cake stand  
soporte para pastel  
présentoir à gâteaux

Rand fixiert die Haube, mit Antirutsch-Füßchen

carved edge fixes the cover, with non-slip feet

ranura para fijar bien la campana, con pies antideslizantes

bord rainuré pour maintenir ferme la cloche, avec pieds antidérapants



	Ø cm	↑ cm	passende Haube / suitable cover / campana adecuada / cloche appropriée
85046	21,5	2,5	06519 <b>NEW</b>
85047	30,5	3,5	06520, 06512
85048	37,5	4,0	06521 <b>NEW</b>



**Torten- / Konditorplatte „LOOPS“**

cake stand  
soporte para pastel  
présentoir à gâteaux



	Ø cm	↑ cm	passende Haube / suitable cover / campana adecuada / cloche appropriée
85033	21,5	2,5	06519 <b>NEW</b>
85034	30,5	3,5	06520, 06512, 06510
85035	37,5	4,0	06521 <b>NEW</b>

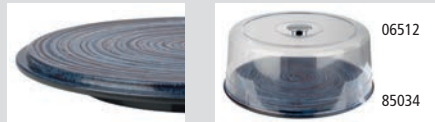

**Torten- / Konditorplatte**

cake stand  
soporte para pastel  
présentoir à gâteaux

Rand fixiert die Haube, mit Antirutsch-Füßchen

carved edge fixes the cover, with non-slip feet

ranura para fijar bien la campana, con pies antideslizantes

bord rainuré pour maintenir ferme la cloche, avec pieds antidérapants



	Ø cm	↑ cm	Farbe / Colour
85044	21,5	2,5	
00468	31,0	3,5	
85045	37,5	4,0	
00469	31,0	3,5	



**Servier- und Tortenplatte „CASUAL“**

cake plate  
porta pasteles  
présentoir à gâteaux



	Ø cm	↑ cm
83890	31	8
83891	31	16



**Servier- und Tortenplatte „CASUAL“**

cake plate  
porta pasteles  
présentoir à gâteaux



	cm	↑ cm
83892	31 x 31	8
83893	31 x 31	16

**NEW CLASSIC**



**Servier- und Tortenplatte „CLASSIC“**

cake stand  
porta pasteles  
présentoir à gâteaux

Rand fixiert die Haube  
carved edge fixes the cover  
ranura para fijar bien la campana  
bord rainuré pour maintenir ferme la cloche



	Ø cm	↑ cm
85049	21,5	9
85050	21,5	17
85051	30,5	9
85052	30,5	17
85053	37,5	9
85054	37,5	17

**Frischhalte- Haube / cover / campana / cloche**



	Ø cm	↑ cm	fits to
06519 <small>NEW</small>	21	17	85049, 85050
06520	30	22	85051, 85052
06521 <small>NEW</small>	36	27	85053, 85054

**Frischhalte- Haube / cover / campana / cloche**



	Ø cm	↑ cm	fits to
06512	30	11,5	85051, 85052



**Servier- und Tortenplatte „ACACIA MINI“**

cake stand  
porta pasteles  
présentoir à gâteaux

Akazienholz geölt  
acacia wood oiled  
madera de acacia aceitada  
bois d'acacia huilé



	Ø cm	↑ cm
33290	9,5	7
33291	13,0	9



**Servier- und Tortenplatte „ACACIA“**

cake stand  
porta pasteles  
présentoir à gâteaux

Akazienholz geölt  
acacia wood oiled  
madera de acacia aceitada  
bois d'acacia huilé



	Ø cm	↑ cm
33292	24,0	8
33293	24,0	16
33294	33,0	8
33295	33,0	16
33296	38,5	8
33297	38,5	16



**Frischhalte- Haube / cover / campana / cloche**



	Ø cm	↑ cm	fits to
06519	21	17	33292, 33293
06520	30	22	33294, 33295
06521	36	27	33296, 33297



**Kaviarkühler**  
caviar cooler  
enfriador de caviar  
rafraîchisseur de caviar



4-teilig: Glasschale Ø 10 cm  
4 pcs.: glass bow Ø 10 cm  
set de 4: bol Ø 10 cm  
set de 4: bol Ø 10 cm

	Ø cm	↑ cm
01699	18	12



75002  
**Spieße**  
skewer

75001  
**Spießständer**  
skewer rack

**Spießständer / Spieße**  
espetada and kebab skewer rack / skewer  
soporte para brochetas  
support pour brochettes



zum Servieren von Fleischspießen bis 40 cm, Gestell aus 8 mm Edelstahl  
to serve skewers up to 40 cm, wire stainless steel 8 mm  
para servir brochetas de carne hasta 40 cm, grosor del alambre 8 mm, inox  
pour présenter les brochettes long. maxi 40 cm, fil 8 mm, inox

	Ø cm	↑ cm	
75001	22,0	46	
75002	0,3	40	4er Set / 4 pcs. set



15925

15926

**Butterservierer**  
butter dish  
mantequillera  
beurrer



	cm	↑ cm
15925	Ø 9	9
15926	9 x 9	9



**Butterservierer**  
butter dish  
mantequillera  
beurrer



hochglanzpoliert / mirror polished finish / acabado brillante / poli brillant

	Ø cm	↑ cm
15921	9	7



**praktischer Ausgießer**  
easy pouring



**Butter- und Saucenwärmer**  
butter and sauce pan warmer  
calentador de mantequilla y salsa  
réchaud à beurre et sauce



Saucentopf mit Ausgießer + Deckel + Gestell (passend für 1 Teelicht)  
pan with spout + lid + riser (for 1 light)  
cacerola + tapadera + soporte (para 1 vela)  
petite casserole avec bec verseur + couvercle + support (pour 1 bougie)

	Ø cm	↑ cm	ltr.	
35350	14	16	0,7	Griff: 13,5 cm / handle: 13,5 cm asa: 13,5 cm / poignée: 13,5 cm



**Sauciere**  
 gravy boat  
 salsaera  
 saucière



hochglanzpoliert, extra schwere Qualität  
 mirror polished finish, high quality  
 acabado efecto espejo, alta calidad, base pesada  
 poli brillant, belle qualité, pied pesant

	cm	↑ cm	ltr.
40208	13 x 6,0	9,0	0,075
40204	16 x 7,5	9,0	0,125
40205	19 x 9,0	13,0	0,25
40206	22 x 10,5	13,5	0,4



**Sauciere**  
 gravy boat  
 salsaera  
 saucière



poliert  
 polished  
 pulido  
 poli

	cm	↑ cm	ltr.
40200	18,0 x 7,5	7,0	0,10
40203	21,5 x 9,5	8,5	0,15
40201	23,5 x 10,0	10,0	0,20
40202	23,5 x 12,0	12,0	0,45



**Thermo-Sauciere**  
 insulated sauce boat  
 salsaera isotérmica  
 saucière thermique



doppelwandig, Klappdeckelverschluss, Einhandbedienung  
 double wall, hinged cover, one-hand operation  
 doble pared, tapa con bisagra, se maneja con 1 mano  
 double paroi, couvercle avec charnière, usage 1 main

	cm	↑ cm	ltr.
40207	19 x 12,5	13	0,4

## Tableware . Table Presentation



### Gourmet-Löffel „GUN-METAL“

party spoon  
cuchara gourmet  
cuillère gourmet

EDELSTAHL  
STAINLESS  
INOX  
18/8



→ cm

00693

12

schwarz / gunmetal look

PVD coated stainless steel



### Gourmet-Löffel „CLASSIC“

party spoon  
cuchara gourmet  
cuillère gourmet

EDELSTAHL  
STAINLESS  
INOX



→ cm

00677

13,5

Edelstahl-Look / stainless steel look

00691

12,0

Gold-Look / gold look

PVD coated stainless steel

00692

12,0

Kupfer-Look / copper look

PVD coated stainless steel



0,05 ltr.

40642



0,12 ltr.

40643



0,32 ltr.

40644

### Stielkasserolle / Serviertopf

sauté pan / mini sauce pan  
cazo recto bajo  
plat à sauter

EDELSTAHL  
STAINLESS  
INOX



40642

∅ cm  
5,5

↑ cm  
2,5

ltr.  
0,05

Griff: 6 cm / handle: 6 cm  
asa: 6 cm / poignée: 6 cm

40643

∅ cm  
7,0

↑ cm  
3,5

ltr.  
0,12

Griff: 8,5 cm / handle: 8,5 cm  
asa: 8,5 cm / poignée: 8,5 cm

40644

∅ cm  
9,5

↑ cm  
5,5

ltr.  
0,32

Griff: 8,5 cm / handle: 8,5 cm  
asa: 8,5 cm / poignée: 8,5 cm





**Glocke**

cloche / dome cover  
campana esférica  
cloche demi-sphère



**außen hochglanzpoliert, innen matt poliert, mit verchromten Griff**

outside mirror polished finish, inside satin polished finish, with chromeplated handle  
exterior pulido acabado efecto espejo, interior pulido acabado efecto satinado, pomo cromado  
extérieur poli brillant, intérieur poli satin, buton chromé

	Ø cm	↑ cm
35734	29	18



**Platzteller**

plate tray  
bajo plato  
assiette de présentation



**Rand eingerollt**

rolled edge  
borde redondeado  
bord rond

	Ø cm	
35735	31	hochglanzpoliert / mirror polished pulido brillante / poli brillant



**Platzteller**

plate tray  
bajo plato  
assiette de présentation



**hochglanzpoliert, mit Fadendekor**

mirror polished finish, with line edge  
pulido efecto espejo, con un filo en relieve  
poli miroir, filet relief

	Ø cm	
35730	30,5	
36233	33,0	



**Platzteller**

plate tray  
bajo plato  
assiette de présentation



**hochglanzpoliert, mit Perlrand**

mirror polished finish, with pearl edge  
acabado pulido efecto espejo, con borde aperlado  
poli miroir, bord perlé

	Ø cm	
35720	30,5	
36323	33,0	



**Untersetzer, 6er Set**

coaster, 6 pcs. set  
posavasos, set de 6  
plateau sous-verre, set de 6



hochglanzpoliert, schwere Ausführung, Rand eingerollt  
mirror polished finish, heavy quality, rolled edge  
acabado pulido efecto espejo, alta calidad, borde redondeado  
effet miroir, bord rond, qualité extra

	Ø cm	pcs.
35711	10	6
35912	12	6



**Serviettenringe, 6er Set**

napkin rings, 6 pcs. set  
servilleteros, set de 6  
anneaux à serviettes, set de 6



	cm	↑ cm	pcs.
04445	6,5 x 4	1	6



**Serviettenringe, 4er Set**

napkin rings, 4 pcs. set  
servilleteros, set de 4  
anneaux porte-serviette, set de 4



	Ø cm	↑ cm	pcs.
04446	4,5	2,5	4



**Besteckkorb „ECONOMIC“**

cutlery dispenser  
dispensador de cubiertos  
corbeille à couverts



in Handarbeit geflochten  
wickerwork  
trensado a mano  
tressage à main

	Ø cm	↑ cm	Farbe / Colour
40130	12	15	
40007	12	15	
40012	12	15	
40013	12	15	



**Besteckkorb „ECONOMIC“**

cutlery dispenser  
dispensador de cubiertos  
corbeille à couverts



in Handarbeit geflochten  
wickerwork  
trensado a mano  
tressage à main

	cm	↑ cm	Farbe / Colour
40131	27 x 10	4,5	
40009	27 x 10	4,5	
40010	27 x 10	4,5	
40011	27 x 10	4,5	



**Table Caddy „COUNTRY STYLE“**

table barrel  
caddy de mesa  
caddy de table



cooler Country-Style, nicht für den direkten Kontakt mit  
Lebensmittel verwendbar

condiment and cutlery holders or even for food presentation, the  
mini barrels should not come into contact with food, they should  
be lined with our greaseproof paper

estilo campo, no aptos para el contacto directo con alimentos,  
sólo usando papel alimenticio

de style champêtre, pas de contact direct avec aliments, seulement  
en utilisant papier alimentaire

	Ø cm	↑ cm
11930	17,5	8,5
11931	11,5	14,0



**Besteckbehälter „ELEMENT“**

cutlery bin  
recipiente para cubiertos  
récipients pour couverts



mit Abflussloch, mit weißem Logo, Bodeneinlage aus Silikon zum Schonen des Bestecks, möbelschonende Unterseite  
with drain hole, with white logo, silicone floor inserts for saving the cutlery, with non-scratching undersurface  
con orificio de drenaje, con logotipo blanco, base de silicona para proteger la cuberteria, con base anti rayaduras  
avec trou de drainage, avec logo blanc, insert de silicone pour proteger la coutellerie, avec revêtement antirayures

	∅ cm	↑ cm	Logo
11935	12	14	fork
11936	12	14	knife
11937	12	14	spoon



**Besteckbehälter „ACACIA“**

cutlery bin  
recipiente para cubiertos  
récipients pour couverts



Akazienholz natur  
acacia wood nature  
madera de acacia natural  
bois d'acacia naturelle

	cm	↑ cm	Logo
11939	14 x 14	15	fork / knife / spoon

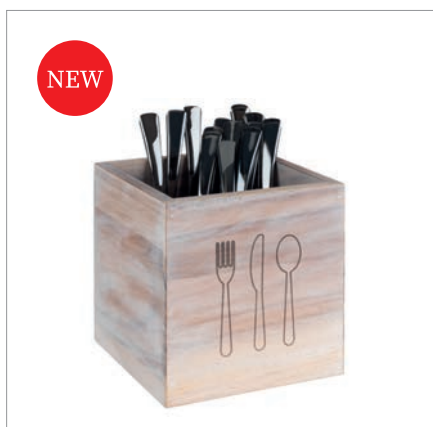

**Besteckbehälter „VINTAGE“**

cutlery bin  
recipiente para cubiertos  
récipients pour couverts



Akazienholz vintage weiß  
acacia wood, vintage white  
madera de acacia, blanca vintage  
bois d'acacia, blanc vintage

	cm	↑ cm	Logo
11938	14 x 14	15	fork / knife / spoon



**Besteckbehälter „ELEMENT“**

cutlery bin  
recipiente para cubiertos  
récipients pour couverts



mit Abflussloch, mit Besteck Logo, Bodeneinlagen aus Silikon  
zum Schonen des Bestecks, möbelschonende Unterseite

with drain hole, with cutlery logo, silicone floor inserts for saving the points of knives,  
with non-scratching underside

con orificio de drenaje, con logotipo de cubertería, soporte de silicona para proteger  
las puntas de los cuchillos, con base antirrayaduras

avec le trou de drainage, avec le logo de coutellerie, insert de silicone pour protéger  
les pointes des couteaux, avec base revêtue antirayures

	Ø cm	↑ cm
00018	11	14



**Tischreste- / Besteckbehälter „TOP CHROME“**

table waste bin / cutlery bin  
papelera de sobremesa / recipiente para cubiertos  
poubelle de table / récipients pour couverts



mit verchromten Rand

with chrome plated ring

con anillo cromado

avec bord chromé

	Ø cm	↑ cm	ltr.	Farbe / Colour
00025	13	15	1	White
00026	13	15	1	Black



**Tischreste- / Besteckbehälter „BASE CHROME“**

table waste bin / cutlery bin  
papelera de sobremesa / recipiente para cubiertos  
poubelle de table / récipients pour couverts



mit verchromten Boden

with chrome bottom

con base cromada

avec base chromée

	Ø cm	↑ cm	ltr.	Farbe / Colour
00019	13	15	1,3	White
00020	13	15	1,3	Black



**Besteckköcher**

cutlery basket  
cesta para cubiertos  
corbeille à couverts



	Ø cm	↑ cm	
11998	9,7	13,7	Kunststoff weiß / white plastic plástico blanco / plastique blanc
11999	9,7	13,7	matt poliert / satin polished finish acero inoxidable / inox

11998  
Köcher weiß

11999  
Köcher Edelstahl



**Tischreste- / Besteckbehälter**

table garbage bin / cutlery bin  
papelera de sobremesa / recipiente para cubiertos  
poubelle de table / récipients pour couverts



**matt poliert, mit abnehmbaren Lochdeckel**  
satin polished finish, with removeable cover  
acabado pulido satinado, con tapa desmontable  
poli mat satiné, avec couvercle démontable ouvert au centre

	Ø cm	↑ cm	ltr.
00028	10	12	0,7



**Tischrestebehälter**

table garbage bin  
papelera de sobremesa  
poubelle de table



**matt poliert, abnehmbarer Schwingdeckel, mit Bajonettverschluss „fester Deckelsitz“**  
satin polished finish, swing cover, cover removable  
acabado satinado, tapa basculante desmontable  
poli mat satiné, couvercle basculant démontable

	Ø cm	↑ cm	ltr.
00029	12	17	1,2
00027	10	13	0,7



**Tischrestebehälter**

table garbage bin  
papelera de sobremesa  
poubelle de table



**Behälter aus weiß lackiertem Metall, Edelstahl-Lochdeckel**  
metall white, stainless cover with hole  
tapa, acero inoxidable, con apertura  
couvercle inox, avec ouverture centrale, récipient en acier laqué blanc

	Ø cm	↑ cm	ltr.
00292	12	15	1,2



**Tischreste- / Besteckbehälter**

table waste bin / cutlery bin  
papelera de sobremesa / recipiente para cubiertos  
poubelle de table / récipients pour couverts



**mit verchromten Rand, inkl. herausnehmbarem Einteiler (4 Fächer)**  
with chrome plated ring, incl. divider (4 chambers)  
con anillo cromado  
avec bord chromé

	cm	↑ cm	Farbe / Colour
00016	14 x 14	16	■



**Tischrestebehälter „SUNDAY“**

table waste bin  
papelera de sobremesa  
poubelle de table



**matt poliert, inkl. Deckel, fester Deckelsitz**  
satin polished finish, incl. cover, cover removable  
acero inoxidable mate, con tapa  
inox mat, avec couvercle

	Ø cm	↑ cm	ltr.
00024	10	18	1,1



**Tischrestehälter**  
table garage bin  
papelera de sobremesa  
poubelle de table



	Ø cm	↑ cm	ltr.	Farbe / Colour
02038	11	14	0,9	White
02039	11	14	0,9	Black



**Tischrestehälter**  
table garbage bin  
papelera de sobremesa  
poubelle de table



	Ø cm	↑ cm	ltr.
00311	14	15	1,2



**Tischrestehälter**  
table garbage bin  
papelera de sobremesa  
poubelle de table



**Kunststoff weiß / granit, abnehmbarer Schwingdeckel**  
white plastic, swing cover, cover removable  
plástico blanco/granita, tapa basculante desmontable  
plastique blanc/gris chiné, couvercle basculant démontable

	Ø cm	↑ cm	ltr.
00031	12	18	1,4



**Tischrestehälter „INTERNATIONAL“**  
table waste bin  
papelera de sobremesa  
poubelle de table



**Deckel-Ring mit Dichtung, internationale Beschriftung**  
cover with sealing ring, internationale Beschriftung  
tapa con junta, texto multi-idiomas  
couvercle avec joint, texte multilingue

	Ø cm	↑ cm	ltr.
83847	10	17,5	1



**Tischrestehälter**  
table garbage bin  
papelera de sobremesa  
poubelle de table



**Behälter aus weiß lackiertem Metall, abnehmbarer Schwingdeckel**  
cover stainless steel bin metal, white, swing cover  
tapa de acero inoxidable, recipiente chapa lacada blanca  
couvercle inox basculant, récipient en acier laqué blanc

	Ø cm	↑ cm	ltr.
00291	12	17	1,2

## Tableware . Table Presentation

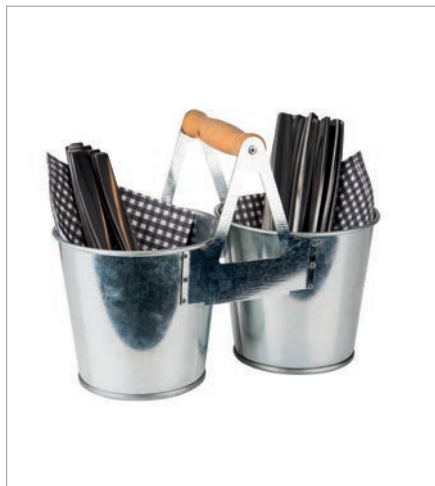

### Besteckbehälter „TIN“

cutlery bin  
recipiente  
récipient

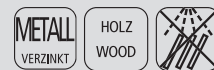

Behälter aus Metall mit Tragegriff aus Holz  
container made of metal with wooden handle  
contenedor de metal con asa de madera  
conteneur métallique avec poignée en bois

	cm	↑ cm
00014	24,5 x 12	18,5



### Tischrestebehälter

table garbage bin  
papelera de sobremesa  
poubelle de table



	Ø cm	↑ cm	ltr
83999	13 / 9	14	1,2



### Besteckköcher

cutlery basket  
cesta para cubiertos  
corbeille à couverts



	cm	↑ cm	Farbe / Colour
84535	12 x 12	16	
84536	12 x 12	16	



### Besteckständer

cutlery basket  
cesta para cubiertos  
égouttoir à couverts



	Ø cm	↑ cm
11921	10	10,0
11922	12	13,5





NEW

**Mini Staffelei, 2 tlg.**  
easel mini, 2 pcs. set  
caballete mini, set de 2  
chevale mini, set de 2

HOLZ  
WOOD

1 Ständer aus Akazienholz, 1 Schild kann senkrecht oder waagrecht verwendet werden  
1 acacia wood stand, 1 sign can be used vertically or horizontally  
1 soporte de madera de acacia, 1 el cartel se puede utilizar vertical u horizontalmente  
1 support en bois d'acacia, 1 le panneau peut être utilisé verticalement ou horizontalement

	cm	↑ cm
71520	13,5 x 10,0	19



waagrecht / horizontal



senkrecht / vertical



71490 Kreide-Marker / chalk marker

**Inhalt ohne Stift**  
content without pen  
contenido sin bolígrafo  
contenu sans stylo



NEW

**Kartenhalter, 2 tlg.**  
menu holder, 2 pcs. set  
soporte de tarjeta de menú, set de 2  
porte-cartes de menu, set de 2

BETON  
CONCRETE

ACRYL  
ACRYLIC

1 Fuß aus Beton, 1 Menühalter aus Acryl  
1 concrete base, 1 acrylic menu sign / holder  
1 base de hormigón, 1 letrero de menú acrílico  
1 socle en béton, 1 plaque de menu en acrylique

	cm	↑ cm
71496	11,5 x 4,5	10



NEW

**Kartenhalter, 2 tlg.**  
menu holder, 2 pcs. set  
soporte de tarjeta de menú, set de 2  
porte-cartes de menu, set de 2

BETON  
CONCRETE

ACRYL  
ACRYLIC

1 Fuß aus Beton, 1 Menühalter aus Acryl  
1 concrete base, 1 acrylic menu sign / holder  
1 base de hormigón, 1 letrero de menú acrílico  
1 socle en béton, 1 plaque de menu en acrylique

	cm	↑ cm
71497	15,5 x 6,5	26



NEW

**Tischstation „RAIL“, 4 tlg.**  
table station, 4 pcs. set  
estación de mesa, set de 4  
station de table, set de 4

MF  
MELAMINE

GLAS  
GLASS

EDELSTAHL  
STAINLESS  
INOX

Set: 1 Ständer, 1 Salz-, 1 Pfefferstreuer, 1 Zuckerdosierer  
set: 1 stand, 1 salt and 1 pepper mills, 1 sugar dispenser  
set: 1 soporte, 1 salero y 1 pimentero, 1 azucarero  
set: 1 support, 1 salière et 1 poivrière, 1 distributeur de sucre

	cm	↑ cm	Ersatzgläser / replacement lenses
40475	23 x 9	7,5	40509, 40438, 40439



inkl. Kartenhalter  
incl. card holder

Seite / page 323, 332

## Tableware . Table Presentation



### Kartenhalter, 4er Set

table stands, 4 pcs. set  
portatarjetas, set de 4  
porte-cartes, set de 4



hochglanzpoliert, inkl. 20 schwarze Beschriftungskarten aus Polypropylen  
mirror polished finish, incl. 20 black cards made of polypropylene  
pulido brillante, incl. 20 tarjetas negras de polipropileno  
poli miroir, incl. 20 étiquettes noires en polypropylène

	Ø cm	↑ cm	pcs.	Farbe / Colour
71510	5	10,5	4	stainless steel
71511	5	10,5	4	copper
71512	5	10,5	4	gunmetal



### Kartenhalter, 4er Set

table stands, 4 pcs. set  
portatarjetas, set de 4  
porte-cartes, set de 4



hochglanzpoliert, inkl. 20 schwarze Beschriftungskarten aus Polypropylen  
mirror polished finish, incl. 20 black cards made of polypropylene  
pulido brillante, incl. 20 tarjetas negras de polipropileno  
poli miroir, incl. 20 étiquettes noires en polypropylène

	Ø cm	↑ cm	pcs.	Farbe / Colour
71513	5	15,5	4	stainless steel
71514	5	15,5	4	copper
71515	5	15,5	4	gunmetal



### Kartenhalter, 4er Set

table stands, 4 pcs. set  
portatarjetas, set de 4  
porte-cartes, set de 4



hochglanzpoliert, inkl. 20 schwarze Beschriftungskarten aus Polypropylen  
mirror polished finish, incl. 20 black cards made of polypropylene  
pulido brillante, incl. 20 tarjetas negras de polipropileno  
poli miroir, incl. 20 étiquettes noires en polypropylène

	Ø cm	↑ cm	pcs.	Farbe / Colour
71516	5	20,5	4	stainless steel
71517	5	20,5	4	copper
71518	5	20,5	4	gunmetal



### Kartenhalter-Set

card holder set  
portatarjetas, set  
porte-cartes, set



18-teilig: 6 Kartenhalter 4 x 2,5 cm + 12 Kunststoff-Beschriftungskarten 10 x 6 cm  
18 pcs. set: 6 card holder 4 x 2,5 cm + 12 plastic cards of inscription 10 x 6 cm  
set de 18: 6 soportes 4 x 2,5 cm + 12 tarjetas de plástico 10 x 6 cm  
set de 18: 6 supports 4 x 2,5 cm + 12 étiquettes en plastique 10 x 6 cm

	cm
00022	4 x 2,5



### Beschriftungskarten, 10er Set

designation cards, 10 pcs. set  
tarjetas, set de 10  
étiquettes, set de 10



	cm	✱ mm
00037	7,5 x 5	0,4



### Bankettkartenständer

menu stand / table number  
 porta-etiqueta o carta de sobremesa  
 porte-étiquette de table, porte-menu, ou n° de table



hochglanzpoliert, schwere Qualität  
 mirror polished finish, heavy gauge  
 acero inoxidable de alta calidad  
 inox, belle qualité

	Ø cm	↑ cm
71460	7,5	18,5
71461	7,5	29
71462	7,5	46



### Tischkartenhalter, 4er Set

table stands, 4 pcs. set  
 pinzas porta-etiquetas, set de 4  
 porte-étiquettes à pince, set de 4



hochglanzpoliert, schwerer Fuß, inkl. 20 weiße Beschriftungskarten  
 mirror polished finish, heavy food, incl. 20 white labels  
 acabado brillante, incluye 20 etiquetas en blanco  
 poli brillant, inclut 20 étiquettes blanches

	Ø cm	↑ cm	pcs.
00070	4	10	4



### Tischaufsteller, 10er Set

table stands, 10 pcs. set  
 caballes de mesa, set de 10  
 chevalets de table, set de 10



Ecken abgerundet  
 corners rounded  
 esquinas redondeadas  
 coins arrondies

	cm	↑ cm	pcs.
00011	7,5 x 3,5	5	10
00012	10,5 x 6	6,5	10



### Kartenhalter, 2er Set

card holder, 2 pcs. set  
 soporte de mesa, set de 2  
 support de table, set de 2



inkl. 40 Beschriftungskarten, durch Magnete einfach zusammenklappbar  
 incl. 40 cards, easily foldable with magnets  
 incluye 40 tarjetas, fácil de plegar, con imanes  
 inclut 40 étiquettes, fácil à plier, avec aimants

	cm	↑ cm	pcs.
00076	9 x 3	5,5	2

## Tableware . Table Presentation



### Buffetschilder, 3er Set

buffet signs, 3 pcs. set  
indicadores buffet, set de 3  
petits chevalets de buffet, set de 3

EDELSTAHL  
STAINLESS  
INOX



können mit einem wasserfesten Filzschreiber beschrieben werden  
can be marked with water-based felt markers  
pueden marcarse con rotuladores de agua  
écriture facile avec un feutre lavable à l'eau

	cm	↑ cm	pcs.
03610	12 x 6	6	3

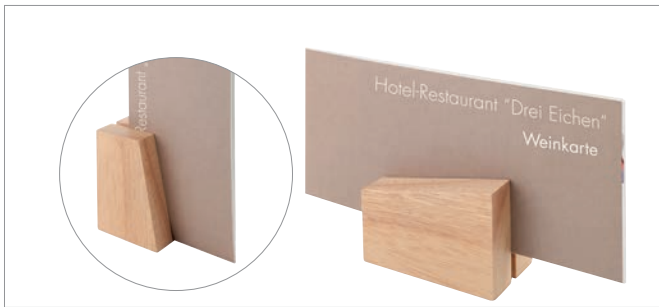

### Kartenhalter, 2er Set

menu holder, 2 pcs. set  
porta cartas de mesa, set de 2  
supports pour menu de table, set de 2

HOLZ  
WOOD



	cm	↑ cm	pcs.
00023	8,5 x 6	4,5 / 8,5	2



### Kartenhalter, 2er Set

menu holder, 2 pcs. set  
porta cartas de mesa, set de 2  
porte-menus de table, set de 2

EDELSTAHL  
STAINLESS  
INOX



**matt poliert**  
satin polished finish  
pulido satinado  
poli mat satiné

	cm	↑ cm	pcs.
00021	8,5 x 4	4 / 8,5	2

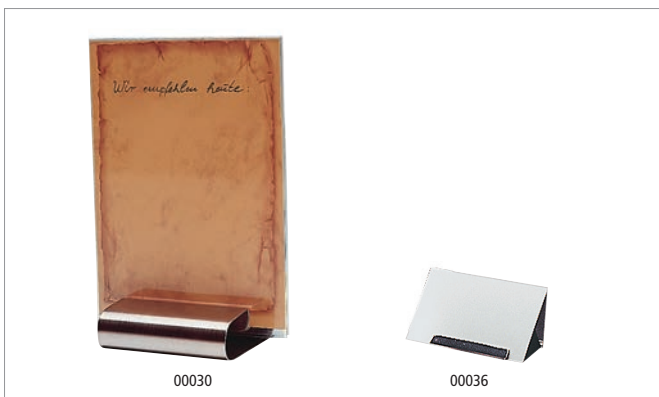

### Tischkartenhalter

table stand  
soporte-carta para la mesa  
support pour menu de table

EDELSTAHL  
STAINLESS  
INOX



**matt poliert**  
satin polished finish  
pulido satinado  
poli mat satiné

	cm	↑ cm	pcs.
00030	8 x 7,0	2	1
00036	6 x 4,5	4	1

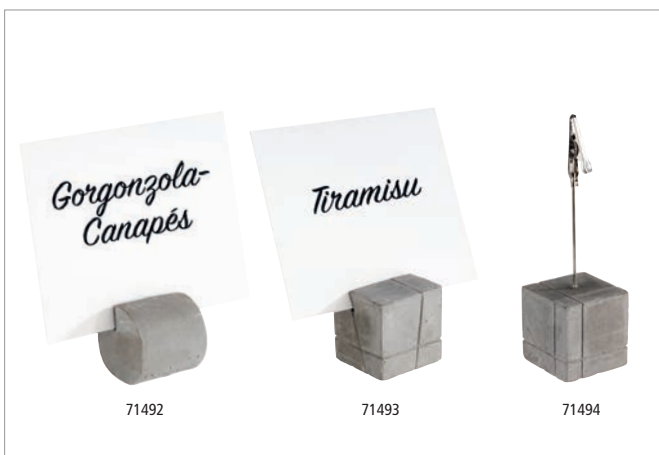

### Kartenhalter-Set, 4er Set

table stands, 4 pcs. set  
portatarjetas, set de 4  
porte-cartes, set de 4

BETON  
CONCRETE



inkl. 30 Beschriftungskarten (15 x weiß + 15 x schwarz)  
incl. 30 labels ( 15 x white + 15 x black)  
incl. 30 tarjetas (15 x blanco + 15 x negro)  
incl. 20 étiquettes (15 x blanc + 15 x noir)

	cm	↑ cm	pcs.
71492	3 x 3	3	4
71493	3 x 3	3	4
71494	3 x 3	12	4



**Kartenhalter, 4er Set**

table stands, 4 pcs. set  
soportes de mesa, set de 4  
support de table, set de 4



inkl. 20 weiße Beschriftungskarten ca. 10 x 8 cm

incl. 20 white labels 10 x 8 cm

incluye 20 etiquetas blancas 10 x 8 cm

20 étiquettes blanches incluses 10 x 8 cm

	cm	↑ cm	pcs.	Farbe / Colour
00074	3 x 3	12	4	



**Kartenhalter, 4er Set**

table stands, 4 pcs. set  
soportes de mesa, set de 4  
support de table, set de 4



inkl. 20 weiße Beschriftungskarten ca. 10 x 8 cm

incl. 20 white labels 10 x 8 cm

incluye 20 etiquetas blancas 10 x 8 cm

20 étiquettes blanches incluses 10 x 8 cm

	cm	↑ cm	pcs.	Farbe / Colour
00700	2,5 x 2,5	12	4	



**Kartenhalter „WÜRFEL“, 4er Set**

table stands, 4 pcs. set  
soporte de mesa, set de 4  
porte-étiquettes, set de 4



inkl. 20 weiße Beschriftungskarten ca. 10 x 8 cm, mehrfach beschriftbar

incl. 20 white labels 10 x 8 cm

incluye 20 etiquetas blancas 10 x 8 cm

20 étiquettes blanches incluses 10 x 8 cm

	cm	pcs.
00078	3 x 3 x 3	4



**Kartenhalter „ZYLINDER“, 4er Set**

table stands, 4 pcs. set  
soporte de mesa, set de 4  
porte-étiquettes, set de 4



inkl. 20 weiße Beschriftungskarten ca. 10 x 8 cm, mehrfach beschriftbar

incl. 20 white labels 10 x 8 cm

incluye 20 etiquetas blancas 10 x 8 cm

20 étiquettes blanches incluses 10 x 8 cm

	cm	pcs.
00079	3 x 3 x 3	4



**Tafelhalter / Schild**

slate sign  
caballete de mesa, pizarra  
plaque signalétique avec support



	cm	↑ cm
00060	12 x 4	7

## Tableware . Table Presentation



### Kartenhalter, 2er Set

table stands, 2 pcs. set  
portatarjetas, set de 2  
porte-cartes, set de 2

BETON  
CONCRETE



inkl. 30 Beschriftungskarten ca. 10 x 8 cm (15 x weiß + 15 x schwarz)  
incl. 30 labels 10 x 8 cm (15 x white + 15 x black)  
incl. 30 tarjetas 10 x 8 cm (15 x blanco + 15 x negro)  
incl. 20 étiquettes 10 x 8 cm (15 x blanc + 15 x noir)

	cm	↑ cm	pcs.
71495	8 x 3,5	6	2

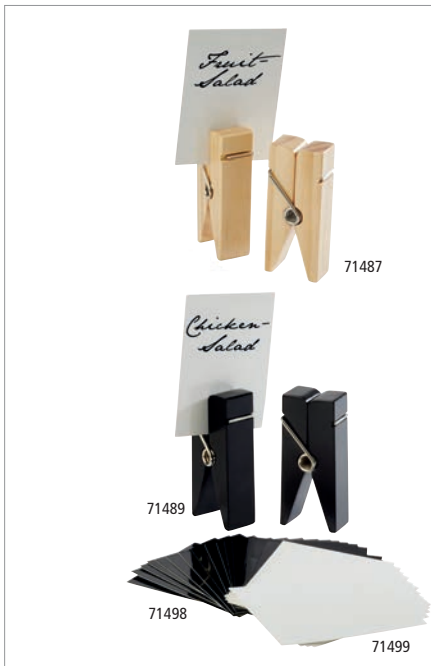

### Kartenhalter, 2er Set „KLAMMER“

table stand, 2 pcs. set  
soporte de mesa, set de 2  
support de table, set de 2

HOLZ  
WOOD



inkl. 30 Beschriftungskarten ca. 10 x 8 cm (15 x weiß, 15 x schwarz)  
incl. 30 cards 10 x 8 cm (15 x white, 15 x black)  
incluye 30 tarjetas 10 x 8 cm (15 x blanco, 15 x negro)  
inclut 30 étiquettes 10 x 8 cm (15 x blanc, 15 x noir)

	cm	↑ cm	pcs.	Farbe / Colour
71487	4 x 2,5	10	2	■
71489	4 x 2,5	10	2	■

Beschriftungskarten, 50 Stück / designation cards, 50 pcs. set  
cartelitos de designación, 50 piezas / cartes de désignation, 50 pièces

	cm	pcs.	Farbe / Colour	fits to
71498	10 x 8	50	■	71487, 71489
71499	10 x 8	50	■	71487, 71489



### Tischkartenhalter „PROFI“

table stand  
soporte de mesa  
support de table

METALL  
VERCHROMT



	cm	↑ cm
40425	9,5 x 7,5	13,5



### Tischkartenhalter

table stand  
soporte de mesa  
support de table

EDELSTAHL  
STAINLESS  
INOX



möbelschonende Unterseite  
non-scratching undersurface  
con base antirrayaduras  
avec base revêtue antirayures

	cm	↑ cm
00071	14 x 5,5	14



### Schilderhalter „FLEXIBEL“

sign holder  
soporte para cartelito  
support pour menu de table



biegsamer Draht mit zwei Klemmen, extrem flexibel, die Klemmen lassen sich weit öffnen  
bedable metal coil adds visual interest, two metal clip open  
metal cromado flexible, 2 pinzas con gran apertura  
métal chromé, flexible, 2 pinces à grande ouverture

	→ cm	
71470	12	ohne Schilder / without signs sin cartelitos / sans étiquette
71471	23	ohne Schilder / without signs sin cartelitos / sans étiquette
71480	12	inkl. 10 Schilder 11879 / incl. 10 signs 11879 con 10 cartelitos 11879 / avec 10 étiquettes 11879

Schilder, 10er Set / signs, 10 pcs. set / set de 10 cartelitos / set de 10 étiquettes

	cm	
11879	7,7 x 5,2	
12879	5,0 x 3,0	



### 10 Beschriftungsclips, inkl. 10 Schilder

10 sign holders, with 10 signs  
10 soportes + 10 cartelitos  
10 supports + 10 étiquettes



	cm	Farbe / Colour
71482	6 x 2,7	White
71483	6 x 2,7	Black

Schilder, 10er Set / signs, 10 pcs. set / set de 10 cartelitos / set de 10 étiquettes

	cm	
11879	7,7 x 5,2	
12879	5,0 x 3,0	



### 10 Schilderhalter „FLEX CLIP“

10 sign holders  
10 clips  
10 porte-étiquettes



Durch die bewegliche Verbindung der Klemme und Schilderhalterung ein extrem flexibler Cliphalter!  
multi angle ticket clip / inclinable con pinza / inclinable avec pince

	→ cm	Farbe / Colour
71472	9,5	White
71474	9,5	Black

Schilder, 10er Set / signs, 10 pcs. set / set de 10 cartelitos / set de 10 étiquettes

	cm	pcs.
11879	7,7 x 5,2	10
12879	5,0 x 3,0	10



### Tischaufsteller 2er Set

table stands, 2 pcs. set  
caballetes de mesa, set de 2  
chevalets de table, set de 2



	cm	↑ cm	
00017	5,5 x 5	3,5	reserviert
00013	5,5 x 5	3,5	reserved
00572	5,5 x 5	3,5	smoking

## Tableware . Table Presentation



### Kartenhalter, 4er Set

table stands, 4 pcs.  
portatarjetas, set de 4  
porte-cartes, set de 4



inkl. 30 Beschriftungskarten ca. 10 x 8 cm (15x weiß, 15x schwarz)

incl. 30 lables 10 x 8 cm (15x white + 15x black)

incl. 30 tarjetas 10 x 8 cm (15x blanco + 15x negro)

incl. 30 étiquettes 10 x 8 cm (15x blanc + 15x noir)

	Ø cm	↑ cm	Farbe / Colour	pcs.
71425	3	10	Marmor weiß / marble white	4
71427	3	10	Marmor grau / marble grey	4



### Kartenhalter, 4er Set

table stands, 4 pcs.  
portatarjetas, set de 4  
porte-cartes, set de 4



inkl. 30 Beschriftungskarten ca. 10 x 8 cm (15x weiß, 15x schwarz)

incl. 30 lables 10 x 8 cm (15x white + 15x black)

incl. 30 tarjetas 10 x 8 cm (15x blanco + 15x negro)

incl. 30 étiquettes 10 x 8 cm (15x blanc + 15x noir)

	cm	↑ cm	Farbe / Colour	pcs.
71426	3,5 x 3,5	10	Marmor weiß / marble white	4
71428	3,5 x 3,5	10	Marmor grau / marble grey	4



### Beschriftungsetiketten

labeling labels  
etiquetas  
étiquettes



12 Bögen mit je 6 Motiven, selbstklebend, mit wasserlöslichem Stift beschreibbar

12 sheets includes 6 self-adhesive and removable labels, use regular chalkboard markers and wipe clean with a clamp cloth

12 hojas, cada una con 6 motivos autoadhesivos, se pueden marcar con un rotulador lavable con agua

12 feuilles chacune avec 6 motifs autoadhésifs, on peut écrire avec un stylo lavable à l'eau

	cm	Farbe / Colour
00069	8,0 x 4,6	■



### Kreide-Marker, Stärke 2 mm, 2er Set

chalk marker, 2 pcs. set  
rotulador de tiza, set de 2  
marqueur a la craie liquide, set de 2



Zum Gestalten und Beschriften von Tafeln, Glas und fast allen geschlossenen Oberflächen, deckende Flüssigkreide auf Wasserbasis, feucht abwischbar

For decorating and writing on boards, glass and almost all non-porous surfaces, opaque water-based liquid chalk, wet-wipeable

Rotuladores para pizarra de tiza líquida para decorar y escribir sobre pizarras, cristales y casi todas las superficies no porosas. Tizi líquida opaca al agua que se pueda borrar con un trapo

Pour décorations et inscriptions sur tableaux, verre et presque toutes les surfaces non poreuses, craie liquide opaque à base d'eau, effaçable avec un chiffon humide

	Ø cm	↑ cm	Farbe / Colour	pcs.
71490	1	13	■	2
71491	1	13	■	2





**Rechnungstablett**

bill presenter  
porta cuenta  
porte-addition



mit Klemme für Rechnung  
with clip for bill  
con clip para la nota  
avec clip pour la note

	cm	↑ cm
30108	20 x 12	0,5



**Rechnungstablett**

bill presenter  
porta cuenta  
porte-addition



mit Klemme für Rechnung  
with clip for bill  
con clip para la nota  
avec clip pour la note

	cm	↑ cm
30110	17 x 11	1



**Rechnungstablett, 2er Set**

bill presenter, 2 pcs. set  
porta cuenta, set de 2  
porte-addition, set de 2



1 Edeltahl-Tablett hochglanzpoliert + 1 klappbare Ledermappe  
mit Stiftflasche, mit Magnethalterung

1 stainless tray mirror polished finish + 1 leather presenter, with magnetic system

1 bandeja de acero inoxidable pulido brillante + 1 presentador de cuero con sistema magnético

1 plateau inox poli brillant + 1 pochette cuir aimantée

	cm	↑ cm
30109	20 x 16	2



**Tischkrümelentferner**

crumber  
recogemigas  
ramasse-miettes



matt poliert

satin polished finish

acabado mate, fácil de usar, mango hueco

mat satiné, manche creux, simple à utiliser

	Ø cm	↑ cm	
00058	6,5 x 2,5	22	Hohlgriff / hollow handles
00581	19,5 x 4,5	1	geschliffene Edeltahlkante flat grinded stainless steel edge



**Pfeffermühle „COPPER“**

pepper mill  
molinillo de pimienta  
moulin à poivre



**Mahlwerk aus Carbonstahl, Mahlgrad stufenlos einstellbar**

mill in carbon steel, the grinding degree can be adjusted infinitely  
molinillo de acero al carbono, el grado de molino se puede ajustar de modo continuo  
moulin en acier de carbone, la finesse de mouture se peut régler de façon continue

	∅ cm	↑ cm
40551	6	15



**Salzmühle „COPPER“**

salt mill  
molinillo de sal  
moulin à sel



**Mahlwerk aus Edelstahl, Mahlgrad stufenlos einstellbar**

mill in stainless steel, the grinding degree can be adjusted infinitely  
molinillo de acero inoxidable, el grado de molino se puede ajustar de modo continuo  
moulin en acier inox, la finesse de mouture se peut régler de façon continue

	∅ cm	↑ cm
40552	6	15



**Pfeffermühle „FRIDA“**

pepper mill  
molinillo de pimienta  
moulin à poivre

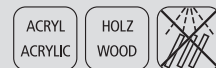

**Mahlwerk aus Carbonstahl, Mahlgrad stufenlos einstellbar**

mill in carbon steel, the grinding degree can be adjusted infinitely  
molinillo de acero al carbono, el grado de molino se puede ajustar de modo continuo  
moulin en acier de carbone, la finesse de mouture se peut régler de façon continue

	∅ cm	↑ cm
40549	6	15,5



**Salzmühle „FRIDA“**

salt mill  
molinillo de sal  
moulin à sel

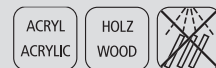

**Mahlwerk aus Edelstahl, Mahlgrad stufenlos einstellbar**

mill in stainless steel, the grinding degree can be adjusted infinitely  
molinillo de acero inoxidable, el grado de molino se puede ajustar de modo continuo  
moulin en acier inox, la finesse de mouture se peut régler de façon continue

	∅ cm	↑ cm
40550	6	15,5





**Pfeffermühle „DIAMOND“**

pepper mill  
molinillo de pimienta  
moulin à poivre



**Mahlwerk aus Carbonstahl, Mahlgrad stufenlos einstellbar**

mill in carbon steel, the grinding degree can be adjusted infinitely  
molinillo de acero al carbono, el grado de molino se puede ajustar de modo continuo  
moulin en acier de carbone, la finesse de mouture se peut réglée de façon continue

	Ø cm	↑ cm
40553	6	18



**Salzmühle „DIAMOND“**

salt mill  
molinillo de sal  
moulin à sel



**Mahlwerk aus Edelstahl, Mahlgrad stufenlos einstellbar**

mill in stainless steel, the grinding degree can be adjusted infinitely  
molinillo de acero inoxidable, el grado de molino se puede ajustar de modo continuo  
moulin en acier inox, la finesse de mouture se peut réglée de façon continue

	Ø cm	↑ cm
40554	6	18



**Pfeffermühle „GUNMETAL“**

pepper mill  
molinillo de pimienta  
moulin à poivre



**Mahlwerk aus Carbonstahl, Mahlgrad stufenlos einstellbar**

mill in carbon steel, the grinding degree can be adjusted infinitely  
molinillo de acero al carbono, el grado de molino se puede ajustar de modo continuo  
moulin en acier de carbone, la finesse de mouture se peut réglée de façon continue

	Ø cm	↑ cm
40555	6	15,5

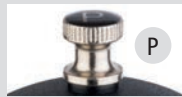

**Salzmühle „GUNMETAL“**

salt mill  
molinillo de sal  
moulin à sel



**Mahlwerk aus Edelstahl, Mahlgrad stufenlos einstellbar**

mill in stainless steel, the grinding degree can be adjusted infinitely  
molinillo de acero inoxidable, el grado de molino se puede ajustar de modo continuo  
moulin en acier inox, la finesse de mouture se peut réglée de façon continue

	Ø cm	↑ cm
40556	6	15,5





**Pfeffermühle „ELEMENT“**

pepper mill  
molinillo de pimienta  
moulin à poivre

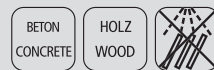

**Mahlwerk aus Carbonstahl, Mahlgrad stufenlos einstellbar**

mill in carbon steel, the grinding degree can be adjusted infinitely  
molinillo de acero al carbono, el grado de molino se puede ajustar de modo continuo  
moulin en acier de carbone, la finesse de mouture se peut régler de façon continue

	Ø cm	↑ cm
40557	7,5	15,5



**Salzmühle „ELEMENT“**

salt mill  
molinillo de sal  
moulin à sel

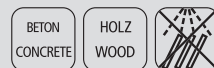

**Mahlwerk aus Edelstahl, Mahlgrad stufenlos einstellbar**

mill in stainless steel, the grinding degree can be adjusted infinitely  
molinillo de acero inoxidable, el grado de molino se puede ajustar de modo continuo  
moulin en acier inox, la finesse de mouture se peut régler de façon continue

	Ø cm	↑ cm
40558	7,5	15,5



**Pfeffermühle „ELEMENT“**

pepper mill  
molinillo de pimienta  
moulin à poivre

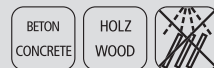

**Mahlwerk aus Carbonstahl, Mahlgrad stufenlos einstellbar**

mill in carbon steel, the grinding degree can be adjusted infinitely  
molinillo de acero al carbono, el grado de molino se puede ajustar de modo continuo  
moulin en acier de carbone, la finesse de mouture se peut régler de façon continue

	Ø cm	↑ cm
40538	6	18

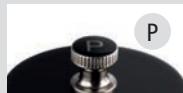

**Salzmühle „ELEMENT“**

salt mill  
molinillo de sal  
moulin à sel

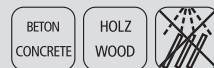

**Mahlwerk aus Edelstahl, Mahlgrad stufenlos einstellbar**

mill in stainless steel, the grinding degree can be adjusted infinitely  
molinillo de acero inoxidable, el grado de molino se puede ajustar de modo continuo  
moulin en acier inox, la finesse de mouture se peut régler de façon continue

	Ø cm	↑ cm
40539	6	18





**Pfeffer- u. Salzmühle „PROFESSIONAL“**

salt / pepper mill  
 molinillo de sal / pimienta  
 moulin à sel / poivre



**Mahlgrad stufenlos einstellbar**

the grinding degree can be adjusted infinitely  
 el grado de molino se puede ajustar de modo continuo  
 la finesse de mouture se peut réglée de façon continue

	Ø cm	↑ cm	Farbe / Colour	
40540	5,5	15		pepper mill
40541	5,5	15		salt mill



**Pfeffermühle „PROFESSIONAL VINTAGE“**

pepper mill  
 molinillo de pimienta  
 moulin à poivre



**Deutsches Buchenholz, vintage, Mahlwerk aus Carbonstahl, Mahlgrad stufenlos einstellbar**

German beechwood, vintage, mill in carbon steel,  
 the grinding degree can be adjusted infinitely  
 madera de haya alemana, carácter „vintage“, molinillo de acero al carbono, el grado de molino se puede ajustar de modo continuo  
 bois de hêtre d'Allemagne, vintage, moulin en acier de carbone, la finesse de mouture se peut réglée de façon continue

	Ø cm	↑ cm	Farbe / Colour
40535	5,5	15	
40537	6,0	23	
40546	5,5	15	
40548	6,0	23	



**Pfeffermühle**

pepper mill  
 molinillo de pimienta  
 moulin à poivre



**Mahlwerk aus Carbonstahl, Mahlgrad stufenlos einstellbar**

mill in carbon steel, the grinding degree can be adjusted infinitely  
 molinillo de acero al carbono, el grado de molino se puede ajustar de modo continuo  
 moulin en acier de carbone, la finesse de mouture se peut réglée de façon continue

	Ø cm	↑ cm	Farbe / Colour
40559	5,5	18	



**Salzmühle**

salt mill  
 molinillo de sal  
 moulin à sel



**Mahlwerk aus Edelstahl, Mahlgrad stufenlos einstellbar**

mill in stainless steel, the grinding degree can be adjusted infinitely  
 molinillo de acero inoxidable, el grado de molino se puede ajustar de modo continuo  
 moulin en acier inox, la finesse de mouture se peut réglée de façon continue

	Ø cm	↑ cm	Farbe / Colour
40560	5,5	18	



**Salzmühle „PROFESSIONAL VINTAGE“**

salt mill  
molinillo de sal  
moulin à sel



Deutsches Buchenholz, vintage, Mahlwerk aus Edelstahl, Mahlgrad stufenlos einstellbar

German beechwood, vintage, mill in stainless steel, the grinding degree can be adjusted infinitely

madera de haya alemana, carácter „vintage“, molinillo de acero inoxidable, el grado de molino se puede ajustar de modo continuo

bois de hêtre d'Allemagne, vintage, moulin en acier inox, la finesse de mouture se peut régler de façon continue

	Ø cm	↑ cm	Farbe / Colour
40536	5,5	15	
40547	5,5	15	



**Pfeffermühle „PROFESSIONAL“**

pepper mill  
molinillo de pimienta  
moulin à poivre



Mahlwerk aus Carbonstahl, Mahlgrad stufenlos einstellbar

mill in carbon steel, the grinding degree can be adjusted infinitely

molinillo de acero al carbono, el grado de molino se puede ajustar de modo continuo

moulin en acier de carbone, la finesse de mouture se peut régler de façon continue

	Ø cm	↑ cm	Farbe / Colour	
40530	5,5	15		Holz / wood
40532	7,0	30		Holz / wood
40534	7,0	40		Holz / wood



Mahlgrad einstellbar  
grinder setting

	Ø cm	↑ cm	Farbe / Colour	
40520	5,5	15		Holz / wood
40522	7,0	30		Holz / wood
40524	7,0	40		Holz / wood



Mahlgrad einstellbar  
grinder setting



**Salzmühle „PROFESSIONAL“**

salt mill  
molinillo de sal  
moulin à sel



Mahlwerk aus Edelstahl, Mahlgrad stufenlos einstellbar

mill in stainless steel, the grinding degree can be adjusted infinitely

molinillo de acero inoxidable, el grado de molino se puede ajustar de modo continuo

moulin en acier inox, la finesse de mouture se peut régler de façon continue

	Ø cm	↑ cm	Farbe / Colour	
40531	5,5	15		Holz / wood
40521	5,5	15		Holz / wood



**Tablett**

tray  
bandeja  
plateau

mit 2 Absätzen Ø 6 cm  
with 2 holes Ø 6 cm  
con 2 agujeros Ø 6 cm  
avec 2 trous Ø 6 cm



	cm	↑ cm
84039	16,5 x 8,5	1,5



**Naturschieferplatte / Untersetzer**

natural slate tray  
bandeja de pizarra natural  
plateau ardoise naturelle

mit 2 Absätzen Ø 6 cm  
with 2 holes Ø 6 cm  
con 2 agujeros Ø 6 cm  
avec 2 trous Ø 6 cm



	cm	* mm
00971	15 x 8	6 - 9



**2 in 1 Salz- u. Pfeffermühle**

2 in 1 salt / pepper mill  
2 in 1 molinillo de sal / pimienta  
2 in 1 moulin à sel / poivre

Keramik Mahlwerk  
ceramic mechanism  
molinillo de cerámica  
broyeur en céramique



	Ø cm	↑ cm
40545	7,5	18,5



Mahlgrad einstellbar  
grinder setting

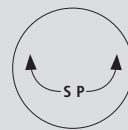

**2 in 1 Salz- u. Pfeffermühle**

2 in 1 salt / pepper mill  
2 in 1 molinillo de sal / pimienta  
2 in 1 moulin à poivre / sel

Keramik Mahlwerk  
ceramic mechanism  
molinillo de cerámica  
broyeur en céramique



	cm	↑ cm
40544	6 x 4,5	9,5



Mahlgrad einstellbar  
grinder setting

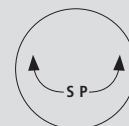



**Käse- oder Gewürzstreuer**

spice shaker  
botes especieros  
saupoudreuse à épices

Löcher Ø 5 mm, inkl. Staubdeckel  
holes Ø 5 mm, incl. cover  
agujeros Ø 5 mm, tapa plástico  
trous Ø 5 mm, couvercle plastique



	Ø cm	↑ cm	ltr.
00775	5,5	7,5	0,15



**Netzstreuer**

mesh top shaker  
polvoreador, tapa con malla fina  
pot à épices, couvercle toile fine

inkl. Staubdeckel  
incl. cover  
tapa plástico  
couvercle plastique



	Ø cm	↑ cm	ltr.
00776	5,5	7,5	0,15



**Streuer fein**

small hole shaker  
polvoreador, tapa con agujeros pequeños  
pot à épices, couvercle à petits trous

Löcher Ø 1 mm, inkl. Staubdeckel  
holes Ø 1 mm, incl. cover  
agujeros Ø 1 mm + tapa plástico  
trous Ø 1 mm + couvercle plastique



	Ø cm	↑ cm	ltr.
00777	5,5	7,5	0,15



**Streuer grob**

large hole shaker  
polvoreador, tapa con agujeros grandes  
pot à épices, couvercle à grands trous

Löcher Ø 2,5 mm, inkl. Staubdeckel  
holes Ø 2,5 mm, incl. cover  
agujeros Ø 2,5 mm + tapa plástico  
trous Ø 2,5 mm + couvercle plastique



	Ø cm	↑ cm	ltr.
00778	5,5	7,5	0,15





**Multistreuer**  
multi-functional shaker  
salero  
saupoudreuse



	Ø cm	↑ cm	ltr.
00774	7	12	0,20



geschlossen



Ø 2 mm



Ø 4 mm



Ø 6 mm



**Multistreuer**  
multi-functional shaker  
salero  
saupoudreuse



	Ø cm	↑ cm	ltr.
00773	6	8	0,05



geschlossen



Ø 2 mm



Ø 4 mm



Ø 6 mm



**Netzstreuer**  
mesh top shaker  
polvoreador, tapa con malla fina  
pot à épices, couvercle toile fine



	Ø cm	↑ cm	ltr.
00781	6,5	12	0,20



**Multistreuer / Gewürzstreuer**  
multi-functional shaker  
juego dosificador  
jeu de salières



	Ø cm	↑ cm	ltr.
00782	6,5	12	0,20

00783	6,5	12	0,20	mit 8 Löchern / with 8 holes con 8 agujeros / avec 8 trous
-------	-----	----	------	---



00782 - Ø 2 mm



00783 - Ø 8 mm

## Tableware . Table Presentation



### Salz- und Pfefferstreuer, 2er Set

salt - and pepper shaker, 2 pcs. set  
piezas de sal y pimienta, set de 2  
sel et poivre, set de 2



	Ø cm	↑ cm	pcs.	
40500	5	6,5	2	glatte Ausführung / smooth version versión recta / forme lisse
40501	5	6,5	2	geriffelte Ausführung / fluted version versión ondulada / forme ondulée
40507	6	10,0	2	



### Allzweckstreuer, 12er Set

shaker, 12 pcs. set  
dosificador, set de 12  
salières/poivrières, set de 12



	cm	↑ cm	pcs.	
40504	4 x 4	10	12	13 Löcher / 13 holes 13 agujeros / 13 trous
40505	4 x 4	10	12	3 Löcher / 3 holes 3 agujeros / 3 trous



40504

40505



### Ministreuer, 4er Set

smaller shaker, 4 pcs. set  
bodegas pequeñas, set de 4  
mini-salières, set de 4



	Ø cm	↑ cm	pcs.
40503	3,5	4	4



### Salzstreuer

salt shaker  
salero  
salière



#### Pommes-Frites Streuer mit Schraubkappe

for french fries, cover to screw  
para patatas fritas, tapa de rosca  
pour les frites, couvercle à visser

	Ø cm	↑ cm	
00779	8	17	Aluminium / aluminium aluminio / aluminium
00772	8	17	Edelstahl / stainless steel acero inoxidable / inox



**Pfeffer- & Salz-Menage „WOOD“**

salt- and pepper-menage  
salero-pimentero  
ménage sel et poivre



**matt poliert, Glasbehälter mit Edelstahl-Deckel und Deckelverschluss**  
satin polished finish, glass with stainless steel cover  
pulido acabado efecto satinado, cristal con tapa de acero inoxidable  
verre et inox mat satiné

	cm	↑ cm
40435	11,5 x 5,5	17



**Essig- & Öl-Menage „WOOD“**

oil- and vinegar-menage  
aceitera-vinagrera  
ménage huile et vinaigre



**matt poliert, Glasbehälter mit Edelstahl-Deckel und Deckelverschluss**  
satin polished finish, glass with stainless steel cover  
pulido acabado efecto satinado, cristal con tapa de acero inoxidable  
verre et inox mat satiné

	cm	↑ cm
40436	16 x 7,5	24,5



**Pfeffer-, Salz-, Essig- und Öl-Menage „WOOD“**

salt- and pepper- and oil- and vinegar-menage  
salero-pimentero & aceitera-vinagrera  
ménage sel et poivre & huile et vinaigre



**matt poliert, möbelschonende Unterseite**  
satin polished finish, glass with stainless steel cover  
pulido acabado efecto satinado, con tapa de acero inoxidable  
verre et inox mat satiné, avec couvercle inox

	cm	↑ cm
40437	15,5 x 12	24,5

**Salz- und Pfefferstreuer / salt - and pepper shaker / juego de sal y pimienta / set sel et poivre**

	Ø cm	↑ cm	
40438	4	9	6 Löcher - Ø 1,85 mm
40439	4	9	18 Löcher - Ø 1,35 mm

**Ersatzglas Essig / Öl / spare glass vinegar / oil / cristal de recambio con tapa „aceite & vinagre“**  
verre huile ou vinagre

	Ø cm	↑ cm	litr.
40442	6	18,5	0,2



**praktischer Ausgießer**  
no drips pourer

## Tableware . Table Presentation



### Pfeffer- und Salz-Menage „ELEMENT“

salt- and pepper-menage  
salero-pimentero  
ménage sel et poivre



**Beton-Ständer, Glasbehälter mit Edelstahl-Deckel, möbelschonende Unterseite**  
stand made of concrete, glass with stainless steel cover, furniture-friendly underside

soporte de hormigón, recipiente de vidrio con tapa de acero inoxidable, con base anti rayaduras  
support en béton, récipient en verre avec couvercle en acier inox, avec revêtement antirayures

	cm	↑ cm
40410	10 x 6	17



### Essig- und Öl-Menage „ELEMENT“

oil- and vinegar-menage  
aceitera-vinagrera  
ménage huile et vinaigre



**Beton-Ständer, Glasbehälter mit Edelstahl-Deckel und tropffreiem Kunststoff-Ausgießer, möbelschonende Unterseite**

stand made of concrete, glass with stainless steel cover and non-drip nozzle-spout, furniture-friendly underside  
soporte de hormigón, recipiente de vidrio con tapa de acero inoxidable y sistema antigoteo, con base anti rayaduras  
support en béton, récipient en verre avec couvercle en acier inox et verseur antigoutte, avec revêtement antirayures

	cm	↑ cm
40411	14 x 8	25



### Pfeffer-, Salz-, Essig- und Öl-Menage „ELEMENT“

salt- and pepper- and oil- and vinegar-menage  
salero-pimentero & aceitera-vinagrera  
ménage sel et poivre & huile et vinaigre



**Beton-Ständer, Glasbehälter mit Edelstahl-Deckel und Drehverschluss, möbelschonende Unterseite**  
stand made of concrete, glass with stainless steel cover and screw cap, furniture-friendly underside

soporte de hormigón, recipiente de vidrio con tapa de acero inoxidable y tapón de rosca, con base anti rayaduras  
support en béton, récipient en verre avec couvercle en acier inox et bouchon à vis, avec revêtement antirayures

	cm	↑ cm
40412	12,5 x 12,5	25



### Pfeffer-, Salz-, Essig- und Öl-Menage „ELEMENT“

salt- and pepper- and oil- and vinegar-menage  
salero-pimentero & aceitera-vinagrera  
ménage sel et poivre & huile et vinaigre

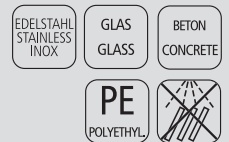

**Beton-Ständer mit Kartenhalterung, Glasbehälter mit Edelstahl-Deckel und Drehverschluss, möbelschonende Unterseite**

stand made of concrete with card holder, glass with stainless steel cover and screw cap, furniture-friendly underside  
soporte de hormigón con tarjetero, recipiente de vidrio con tapa de acero inoxidable y tapón de rosca, con base anti rayaduras  
support en béton avec porte-cartes, récipient en verre avec couvercle en acier inox et bouchon à vis, avec revêtement antirayures

	cm	↑ cm
40413	14 x 13,5	20



mit Kartenhalterung an der Rückseite  
with card holder at the back



**Pfeffer- & Salz-Menage „CLASSIC“**

salt- and pepper-menage  
salero-pimentero  
ménage sel et poivre



**Glasbehälter mit Edelstahl-Deckel und Drehverschluss**

glass with stainless steel cover  
vidrio con tapa de acero inoxidable con rosca  
en verre avec couvercle inox à visser

	cm	↑ cm
40310	10,5 x 6,5	16



**Pfeffer- & Salz-Menage „CLASSIC“**

salt- and pepper-menage  
salero-pimentero  
ménage sel et poivre



**Glasbehälter mit Edelstahl-Deckel und Drehverschluss**

glass with stainless steel cover  
vidrio con tapa de acero inoxidable con rosca  
en verre avec couvercle inox à visser

	Ø cm	↑ cm
40320	10,5	16



**Menage „CLASSIC“**

menage  
menage  
ménage



**Glasbehälter mit Edelstahl-Deckel und tropffreiem Kunststoff-Ausgießer**

with stainless steel cover and non-drip nozzle-spout  
vidrio con tapa inox y sistema antigoteo  
verre avec couvercle inox et verseur antigoutte

	cm	↑ cm	ltr.
40440	14,5 x 8,5	23	0,2
40450	17,5 x 10,5	23	

**Ersatzglas mit Deckel / spare glass with cover / vidrio con tapa / verre + couvercle**

	Ø cm	↑ cm	
40312	4	9	18 Löcher - Ø 1,35 mm
40311	4	9	6 Löcher - Ø 1,85 mm

**Ersatzglas mit Deckel „Essig & Öl“ / spare glass with cover „vinegar & oil“ / cristal de recambio con tapa „vinegar & oil“ / verre huile ou vinaige avec couvercle inox et verseur antigoutte**

	Ø cm	↑ cm	ltr.
40441	6	18,5	0,2

**Ersatzglas mit Deckel „Zahnstocher“ / spare glass with cover „toothpick“ / porta-palillos vidrio con tapa / verre à cure-dents + couvercle**

	Ø cm	↑ cm
40313	4	9



**Senftöpfchen, 2er Set**

mustard glass, 2 pcs. set  
piezas vasos mostaza, set de 2  
verres à moutarde, set de 2



**inkl. Löffel und Edelstahl-Deckel**

incl. spoons and covers  
incluye cucharas y tapas  
cuillères et couvercles inclus

	Ø cm	↑ cm	pcs.
40415	5	6	2



**Menage „ECONOMIC“**

menage  
menage  
ménage



**Glasbehälter mit Edelstahl-Deckel und Drehverschluss**

glass with stainless steel cover  
cristal con tapa inox a rosca  
en verre avec couvercle inox à visser

	cm	↑ cm
40455	8 x 4	13



**Menage „ECONOMIC“**

menage  
menage  
ménage



**Glasbehälter mit Edelstahl-Deckel und Drehverschluss**

glass with stainless steel cover  
cristal con tapa inox a rosca  
en verre avec couvercle inox à visser

	cm	↑ cm
40457	8 x 8	12

**Glas für Senf / glass for mustard / vaso de cristal para mostaza / pot verre seul pour la moutarde**

40464



40458

**Menage „ECONOMIC“**

menage  
menage  
ménage



**Glasbehälter mit Edelstahl-Deckel und tropffreiem Kunststoff-Ausgießer**

glasses with stainless steel cover and non-drip nozzle-spout  
cristales con tapa de acero inoxidable y sistema antigoteo  
en verre avec couvercle inox et insert plastique antigoutte

	cm	↑ cm
40458	11,5 x 5,5	22
40460	11,0 x 10,5	22

**Pfeffer- oder Salz-Glasstreuer / pepper- or salt-glass with cover salero o pimentero de cristal con tapa / salière ou poivrière seule en verre avec couvercle inox**

	Ø cm	↑ cm
40461	3	9

**Essig- oder Öl-Glasbehälter / oil- or vinegar-glass with cover / aceitera-vinagrera con tapa bouteille huile ou vinaigre seule en verre et couv. inox**

	Ø cm	↑ cm
40462	4,5	16

**Glas für Zahnstocher / glass for tooth picks / vaso de cristal para palillos de dientes porte-cure-dents env erre**

	Ø cm	↑ cm
40463	3	6



40460



### Menage „PRO“

menage  
menage  
ménage



**matt poliert, Glasbehälter mit Edelstahl-Deckel und tropffreiem Kunststoff-Ausgießer**

satin polished finish, glass with stainless steel cover and non-drip nozzle-spout

inox satinado, vidrio, sistema antigoteo

inox poli mat satiné et verre, insert plastique antigoutte

	cm	↑ cm
40476	12,0 x 8,0	19
40478	12,5 x 11,0	19
40480	13,0 x 11,0	19

**Pfeffer- oder Salz-Glasstreuer / pepper- or salt-glass with cover / salero o pimentero de cristal con tapa**  
salière ou poivrière seule en verre avec couvercle inox

	Ø cm	↑ cm
40461	3	9

**Essig- oder Öl-Glasbehälter / oil- or vinegar-glass with cover / aceitera-vinagrera con tapa**  
bouteille huile ou vinaigre seule en verre et couv. inox

	Ø cm	↑ cm
40462	4,5	16



### Menage „PRO“

menage  
menage  
ménage



**matt poliert, Glasbehälter mit Edelstahl-Deckel und Drehverschluss**

satin polished finish, glass with stainless steel cover

inox satinado, vidrio y tapas con rosca

inox poli mat satiné et verre, couvercle à visser

	cm	↑ cm
40470	8,5 x 5,7	11,5
40472	9,2 x 8,5	11,5
40474	10,0 x 10,0	11,5



**Parmesan-Menage „CLASSIC“**

cheese dish  
quesera parmesano  
service à parmesan

hochglanzpoliert, inkl. Löffel  
mirror polished finish, with spoon  
pulido efecto espejo, con bol cristal y cuchara  
brillant, avec bol verre et cuillère



	Ø cm	↑ cm
40330	10,5	7

Ersatzbehälter / sparecontainer / bol de recambio / bol de rechange

	Ø cm
40331	10,5



**Parmesan-Menage „PROFI“**

cheese dish  
quesera parmesano  
service à parmesan



	Ø cm	↑ cm
40424	9	5,5

Ersatzbehälter / sparecontainer / bol de recambio / bol de rechange

	Ø cm
40331	10,5



**Parmesan-Menage „PRO“**

cheese dish  
quesera parmesano  
service à parmesan

matt poliert, inkl. Löffel  
satin polished finish, with spoon  
pulido mate satinado, con bol cristal y cuchara  
mat satiné, avec bol verre et cuillère



	Ø cm	↑ cm
40482	10,5	13

Ersatzbehälter / sparecontainer / bol de recambio / bol de rechange

	Ø cm
40331	10,5



**Parmesan-Menage „ECONOMIC“**

cheese dish  
quesera parmesano  
service à parmesan

inkl. Kunststofflöffel  
with spoon  
con cuchara  
avec cuillère



	Ø cm	↑ cm
40453	10,5	7

Ersatzbehälter / sparecontainer / bol de recambio / bol de rechange

	Ø cm
40454	10,5





**Essig- & Öl-Menage**  
oil- and vinegar-menage  
aceitera-vinagrera  
ménage huile et vinaigre



**Glasbehälter mit Deckel und tropffreiem PE-Ausgießer**

glass with lid and non-drip nozzle-spout

recipiente de cristal con tapa y sistema antigoteo

pot en verre avec couvercle et système plastique antigoutte

	cm	↑ cm	litr.
40445	10,5 x 5,5	24	0,12
40446	13,0 x 7,0	34	0,50



**tropffreier Ausgießer**  
non-drip spout



250 ml

**Ständer**  
serving stand  
soporte 2 botellas  
support 2 bouteilles



**matt poliert, passend für handelsübliche 500 ml Flaschen, Lieferung ohne Flaschen**

satin polished finish, for standard bottles with 500 ml content, delivery without bottles

inox satinado, para botellas estándar de 500 ml, se entrega sin botellas

inox mat satiné, pour bouteilles standard de 500 ml, livré sans bouteilles

	cm	↑ cm
40443	13 x 7	30



**Gewürzständer**  
condiment stand  
soporte salsas y condimentos  
porte condiments et sauces



**matt poliert, Lieferung ohne Deko**

satin polished finish

acabado pulido efecto satinado

poli mat satiné

	Ø cm	↑ cm
40300	19	20



**Menage**  
menage  
menage  
ménage



**drehbares Gestell, Glasbehälter mit Edelstahl-Deckel und Drehverschluss**

rotating stand, glass with stainless steel cover

soporte giratorio con piezas de vidrio y tapas inox

tournant, avec pièces en verre et couvercle inox

	Ø cm	↑ cm
40485	16	20



NEW

**Ständer „URBAN“**

serving stand  
soporte 2 botellas  
support 2 bouteilles

Metall schwarz, mit Kartenhalterung  
metal black, with card holder  
metal negro, con tarjetero  
métal noir, avec porte-cartes



	cm	↑ cm
40414	13 x 8,5	25



mit Kartenhalterung an der Rückseite  
with card holder at the back



NEW

350 ml

**Essig- & Öl-Flasche „OLD FASHIONED“**

oil- and vinegar bottle  
botella de aceite y vinagre  
bouteille d'huile et vinaigre

Glasflasche, Edelstahl - Ausgießer mit Deckel  
glass bottle, stainless steel spout with lid  
botella de vidrio, pico verteder de acero inoxidable con tapa  
bouteille en verre, bec verseur en acier inox avec couvercle



	Ø cm	↑ cm	ltr.
40511	7	22	0,35



93308  
200 ml

93309

**Spritzflasche inklusive Ausgießer**

squeeze bottle with nozzle  
botella exprimible con dosificador  
flacon pulvérisateur avec bec verseur

ideal für Bitter-Liköre, Essig, Öl  
perfect for bitter liqueur, vinegar, oil  
perfecto para licores amargos, vinagre, aceite  
idéal pour liqueur amère, vinaigre, huile



	cm	↑ cm	ltr.
93308	6 x 5	20	0,2

Ausgießer passend für Spritzflasche / nozzle suitable for squeeze bottle / dosificador apto para botella exprimible / bec verseur approprié pour flacon pulvérisateur

	Ø cm	↑ cm
93309	2,5	5,5

NEW



350 ml

**Zuckerdosierer „OLD FASHIONED“**

sugar dispenser  
azucarero  
sucrier



Schraubdeckel aus Edelstahl, mit Dosierklappe  
cover stainless steel with dosing flap  
tapa de acero inoxidable, con cierre dosificador  
couvrecl en acier inox, avec couvercle de dosage

	Ø cm	↑ cm	ltr.
40510	7,5	14	0,35



mit Dosierklappe  
with dosing flap



300 ml

**Zuckerdosierer**

sugar dispenser  
azucarero  
sucrier



Schraubdeckel aus Edelstahl  
cover stainless steel  
tapa de acero inoxidable  
couvrecl en acier inox

	Ø cm	↑ cm	ltr.
00766	8,5	15	0,3

Ersatzglasbehälter / spare glass-container / contenedor de repuesto / récipient verre de rechange

00768



40490  
150 ml

**Zuckerdosierer**

sugar dispenser  
azucarero  
sucrier



Schraubdeckel aus Edelstahl, mit Dosierrohr  
cover stainless steel with dosingtube  
tapa de acero inoxidable y tubo dosificador  
couvrecl en acier inox et tube doseur

	Ø cm	↑ cm	ltr.
40490	8,5	12	0,15
40494	8,5	15	0,25

Ersatzglasbehälter / spare glass-container / contenedor de repuesto / récipient verre de rechange

fits to

40498	40490
40499	40494



40494  
250 ml



**Zuckerdosierer**

sugar dispenser  
azucarero  
sucrier



Schraubdeckel aus Edelstahl mattiert, mit Dosierrohr  
cover stainless steel matt polished, with dosing tube  
tapa de rosca de acero inoxidable mate y tubo dosificador  
couvrerle à vis en acier inox mat et tube doseur

	Ø cm	↑ cm	ltr.
40509	6	14,5	0,20



**Zuckerdosierer**

sugar dispenser  
azucarero  
sucrier



Schraubdeckel aus Edelstahl, mit Dosierrohr  
cover stainless steel, with dosing tube  
tapa de acero inoxidable y tubo dosificador  
couvrerle en acier inox et tube doseur

	Ø cm	↑ cm	ltr.
40486	8,0	15	0,25
40506	7,5	17	0,32



**Allzweckgießer**

pourer  
dosificador  
doseur



Schraubdeckel aus Edelstahl und Kunststoff, mit Dosierklappe  
cover stainless steel and plastic, with dosing flap  
tapa de acero inoxidable y plástico, con cierre dosificador  
couvrerle en acier inox et plastique, avec couvercle de dosage

	Ø cm	↑ cm	ltr.
40488	8	12,5	0,25

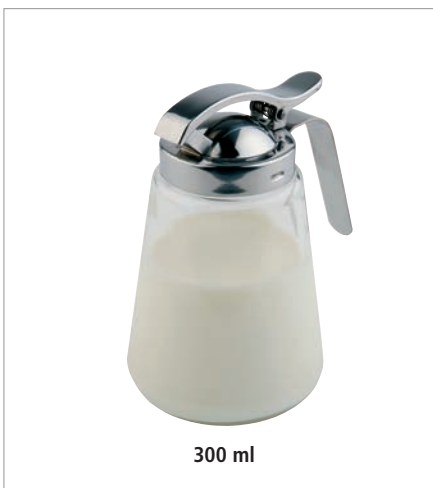

**Allzweckgießer**

pourer  
bote vertedor universal  
pot verseur universel



für Honig, Kaffeesahne, etc., Schraubdeckel aus Edelstahl  
for honey, cream, etc., cover stainless steel  
para miel, crema, etc., tapa de acero inoxidable  
pour le miel, le lait, la crème, etc., couvercle en acier inox

	Ø cm	↑ cm	ltr.
00765	8,5	13,5	0,3

Ersatzglasbehälter / spare glas-container / contenedor de repuesto / récipient verre de rechange

00768



320 ml

**Zuckerdosierer**

sugar dispenser  
azucarero  
sucrier



Schraubdeckel mit Klappe aus Edelstahl, mit Dosierklappe

cover stainless steel, with dosing flap  
tapa acero inoxidable, con cierre dosificador  
couvercle inox, avec couvercle doseur

	Ø cm	↑ cm	ltr.
40487	7,5	13,5	0,32



200 ml

**Zuckerdosierer**

sugar dispenser  
azucarero  
sucrier

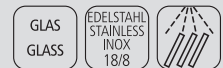

mit Schraubverschluss, Dosier-Rohr Ø 15 mm

cover and dosingtube Ø 15 mm  
con tapa y tubo dosificador Ø 15 mm  
couvercle avec tube doseur Ø 15 mm

	Ø cm	↑ cm	ltr.
40508	6,5	14,5	0,20



170 ml

**Zuckerspender / Milchkännchen**

sugar pourer / milk jug  
dispensador de azúcar  
sucrier doseur



matt poliert

satín polished finish  
pulido efecto satinado  
intérieur et extérieur poli mat

	Ø cm	↑ cm	ltr.
10316	5	15	0,17



**Zuckerkuigel**

sugar pot  
azucarero  
sucrier



hochglanzpoliert, mit Rolldecke

mirror polished finish, rolltop cover  
pulido acabado brillante, tapa abatible  
brillant, couvercle abattant

	Ø cm	↑ cm
00033	13,5	15

## Tableware . Table Presentation



### Butterservierer

butter dish  
mantequillera  
beurrier



	Ø cm	↑ cm
15925	9	9



### Butterservierer

butter dish  
mantequillera  
beurrier



	cm	↑ cm
15926	9 x 9	9



### Butterservierer

butter dish  
mantequillera  
beurrier



hochglanzpoliert  
mirror polished finish  
acabado brillante  
poli brillant

	Ø cm	↑ cm
15921	9	7



### Schale „ENAMELWARE“

bowl  
cuenco  
bol



	cm	↑ cm
40667	16 x 12,0	3,5
40668	18 x 13,5	4,0



hot price

### Kühlschrank-Butterdose

refrigerator butter dish  
mantequillera para nevera  
boîte à beurre pour le frigo



	cm	↑ cm
00063	16 x 9,5	5,5



### Eierbecher

egg holder  
huevera  
coquetier



	Ø cm	↑ cm
00032	8,5	2

# VINTAGE

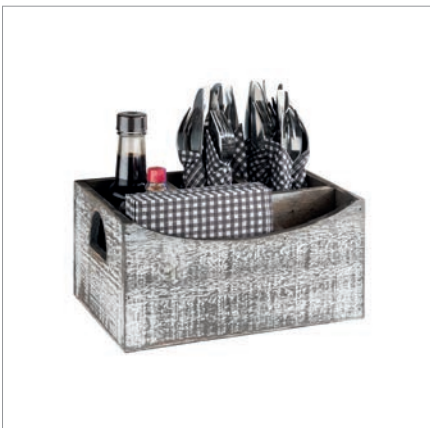
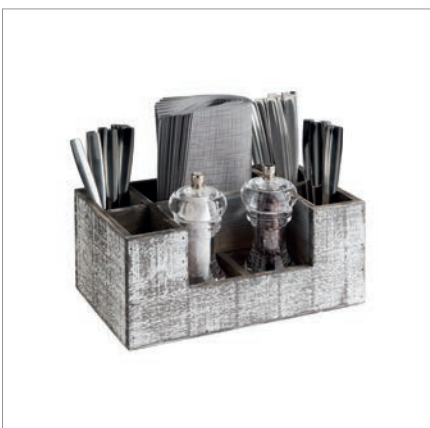

**Table Caddy „VINTAGE“**  
table caddy  
caddy de mesa  
caddy de table



**unterteilt in 5 Fächer**  
divided into 5 compartments  
dividido en 5 compartimentos  
divisé en 5 compartiments

	cm	↑ cm
11608	22 x 15,5	11,5



**Table Caddy „VINTAGE“**  
table caddy  
caddy de mesa  
caddy de table



**unterteilt in 7 Fächer**  
divided into 7 compartments  
dividido en 7 compartimentos  
divisé en 7 compartiments

	cm	↑ cm
11609	25,5 x 15,5	11,5



**Table Caddy „VINTAGE“**  
table caddy  
caddy de mesa  
caddy de table



**unterteilt in 4 Fächer, mit Tragegriff**  
divided into 4 compartments, with handle  
dividido en 4 compartimentos, con asa  
divisé en 4 compartiments, avec poignée

	cm	↑ cm
11610	22 x 15,5	22



**Table Caddy „VINTAGE“**

table caddy  
caddy de mesa  
caddy de table



	cm	↑ cm
11612	15 x 15	10
11613	15 x 15	15

	cm	↑ cm
11614	30 x 15	15

GN 1/1 Tablett / GN tray / GN bandeja / GN plateau



	cm	↑ cm	GN
11615	53 x 32,5	5	1/1



**Buffettisch „MINI VINTAGE“**

buffet stand  
soporte para buffet  
présentoir buffet



	cm	↑ cm	fits to
11634	40 x 21,5	15	GN 1/3 trays





# VINTAGE



Tableware  
Table Presentation



## Holzbox „VINTAGE“

woodbox  
caja madera  
base bois



### Schubladenoptik, mit Knopf

drawer look, with knob  
look cajón, con pomo  
look tiroir, avec bouton

	cm	↑ cm	inner size cm
11631	18,5 x 18,5	11	17 x 17, mit Beschriftungsfach
11630	11,5 x 7,5	5	10 x 6



## Holzbox „VINTAGE“

woodbox  
caja madera  
base bois



### Schubladenoptik, mit Knopf

drawer look, with knob  
look cajón, con pomo  
look tiroir, avec bouton

	cm	↑ cm	inner size cm
11633	18,5 x 18,5	11	17 x 17, mit Beschriftungsfach
11632	11,5 x 7,5	5	10 x 6

## Tableware . Table Presentation



### Table Caddy „VINTAGE“

table caddy  
caddy de mesa  
caddy de table



herausnehmbare Aufteilung, 4-Fächer (7 x 7 cm)  
separation removable, 4 compartments (7 x 7 cm)  
separadores amovibles, 4 compartimentos (7 x 7 cm)  
séparateurs amovibles, 4 compartiments (7 x 7 cm)

	cm	↑ cm	Farbe / Colour
11635	17 x 17	10	White
11636	17 x 17	10	Blue
11637	17 x 17	10	Yellow



### Table Caddy „VINTAGE“

table caddy  
caddy de mesa  
caddy de table



herausnehmbare Aufteilung, 4-Fächer (7 x 7 cm)  
separation removable, 4 compartments (7 x 7 cm)  
separadores amovibles, 4 compartimentos (7 x 7 cm)  
séparateurs amovibles, 4 compartiments (7 x 7 cm)

	cm	↑ cm	Farbe / Colour
11600	17 x 17	16	White
11601	17 x 17	16	Blue
11602	17 x 17	16	Yellow



### Table Caddy „VINTAGE“

table caddy  
caddy de mesa  
caddy de table



herausnehmbare Aufteilung, 6 Fächer (7,5 x 7,5 cm)  
separation removable, 6 compartments (7,5 x 7,5 cm)  
separadores amovibles, 6 compartimentos (7,5 x 7,5 cm)  
séparateurs amovibles, 6 compartiments (7,5 x 7,5 cm)

	cm	↑ cm	Farbe / Colour
11638	27 x 17	10	White
11639	27 x 17	10	Blue
11640	27 x 17	10	Yellow



### Table Caddy „VINTAGE“

table caddy  
caddy de mesa  
caddy de table



herausnehmbare Aufteilung, 6 Fächer (7,5 x 7,5 cm)  
separation removable, 6 compartments (7,5 x 7,5 cm)  
separadores amovibles, 6 compartimentos (7,5 x 7,5 cm)  
séparateurs amovibles, 6 compartiments (7,5 x 7,5 cm)

	cm	↑ cm	Farbe / Colour
11603	27 x 17	16	White
11604	27 x 17	16	Blue
11605	27 x 17	16	Yellow

NEW



**Table Caddy „ACACIA“**

table caddy  
caddy de mesa  
caddy de table



Akazienholz, 3-Fächer

Fach 1+3: 11,5 x 5,5 cm / Fach 2: 12,0 x 11,5 cm

acacia wood, 3 compartments

compartment 1+3: 11,5 x 5,5 cm / compartment 2: 12,0 x 11,5 cm

madera de acacia, 3 compartimentos

compartimento 1+3: 11,5 x 5,5 cm / compartimento 2: 12,0 x 11,5 cm

bois d'acacia, 3 compartiments

compartiments 1+3: 11,5 x 5,5 cm / compartiment 2: 12,0 x 11,5 cm

	cm	↑ cm
40403	27,5 x 13,5	24

passende Brottasche / suitable bread basket / panera a juego / corbeille assortie

	cm	↑ cm	Farbe / Colour
30355	12 x 11,5	11,5	
30356	12 x 11,5	11,5	



**Table Caddy**

table caddy  
caddy de mesa  
caddy de table



Akazienholz, 2-Fächer

acacia wood, 2 compartements

madera de acacia, 2 compartimentos

bois d'acacia, 2 compartiments

	cm	↑ cm	inner size cm
40405	25 x 15	18	21,5 x 8



**Table Caddy „VINTAGE“**

table caddy  
caddy de mesa  
caddy de table



Holz, 2-Fächer (13,5 x 6 cm)

2 compartments (13,5 x 6 cm)

2 compartimentos (13,5 x 6 cm)

2 compartiments (13,5 x 6 cm)

	cm	↑ cm	inner size cm
40404	15,5 x 15,5	15	13,5 x 6

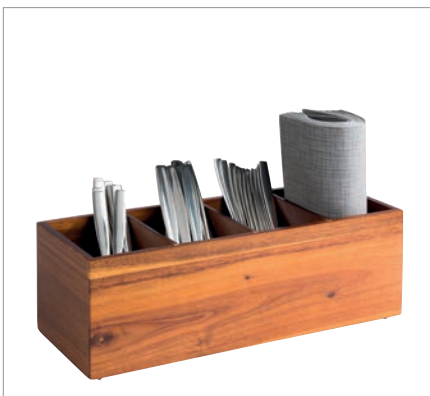

**Holzbox „WOODY“**

woodbox  
caja madera  
base bois



Akazienholz, 4-Fächer

acacia wood, 4 compartements

madera de acacia, 4 compartimentos

bois d'acacia, 4 compartiments

	cm	↑ cm	inner size cm
11649	36 x 14	12,5	12,5 x 8

## Tableware . Table Presentation



### Holzbox „TABLE“

woodbox  
caja madera  
base bois



**Akazienholz, 3 Fächer (6,5 x 6,5 cm)**

acacia wood, 3 compartments (6,5 x 6,5 cm)  
madera de acacia, 3 compartimentos (6,5 x 6,5 cm)  
bois d'acacia, 3 compartiments (6,5 x 6,5 cm)

	cm	↑ cm	inner size cm	€
11727	23,5 x 8,5	4,5	6,5 x 6,5 je Fach / each compartment	12,00



### Holzbox „VINTAGE“

woodbox  
caja madera  
base bois



**Akazienholz, vintage weiß**

acacia wood, vintage white  
madera de acacia, blanca vintage  
bois d'acacia, blanc vintage

	cm	↑ cm	inner size cm
11725	15,0 x 9,5	5	12 x 6,5



### Holzbox „TABLE“

woodbox  
caja madera  
base bois



**Akazienholz natur**

acacia wood nature  
madera de acacia natural  
bois d'acacia naturel

	cm	↑ cm	inner size cm
11726	15,0 x 9,5	5	12 x 6,5



### Table Caddy

table caddy  
caddy de mesa  
caddy de table



**Akazienholz**

acacia wood  
madera de acacia  
bois d'acacia

	cm	↑ cm	inner size cm
11625	23 x 10	10	22,5 x 6



### Holzbox „WOODY“

woodbox  
caja madera  
base bois



**Akazienholz**

acacia wood  
madera de acacia  
bois d'acacia

	cm	↑ cm	inner size cm
11650	15,0 x 15	5,5	13 x 13
11651	22,5 x 15	5,5	13,5 x 13 / 6,5 x 13



### Servierbrett „NARROW“

serving board  
tabla de servir  
planche de service



Akazienholz, mit 3 Vertiefungen Ø 6 cm  
acacia wood, with 3 notches Ø 6 cm  
madera de acacia, con 3 ranuras Ø 6 cm  
bois d'acacia, avec 3 encoches Ø 6 cm

	cm	↑ cm
00878	31 x 11	2



passende Schälchen / fitting bowls / cuencos adecuados / bols apropiés

	Ø cm	↑ cm	ltr.	
40685	6	3	0,05	stainless steel
82316	7	8	0,22	glas



### Besteckbehälter „TIN“

cutlery bin  
recipiente  
réceptier



Behälter aus Metall mit Tragegriff aus Holz  
container made of metal with wooden handle  
contenedor de metal con asa de madera  
conteneur métallique avec poignée en bois

	cm	↑ cm
00014	24,5 x 12	18,5



### Table Caddy „ELEMENT“

table caddy  
caddy de mesa  
caddy de table



Beton, mit möbelschonender Unterseite  
concrete, furniture-friendly underside  
hormigón, con base anti rayaduras  
béton, avec revêtement antirayures

	cm	↑ cm	inner size cm
11647	16,5 x 16	6,5	14,5 x 14



### Table Caddy „ELEMENT“

table caddy  
caddy de mesa  
caddy de table



Beton, mit möbelschonender Unterseite, 2 Löcher je 6,5 cm  
concrete, furniture-friendly underside, 2 holes each 6.5 cm  
hormigón, con base anti rayaduras, 2 agujeros cada uno 6,5 cm  
béton, avec revêtement antirayures, 2 trous de 6,5 cm chacun

	cm	↑ cm	inner size cm
11648	23,5 x 16	6,5	14,5 x 14



**Kerzenleuchter „XXL“**

candle holder  
candelabro  
chandelier



5-flammig, Zinkdruckguss, vernickelt, schwere Ausführung, einfache Montage  
5 branches, zinc alloy nickel-plated, heavy model, easy to assemble  
5 ramas, fundición de aleación de zinc niquelada, alta calidad y fácil montaje  
5 branches, fonte d'alliage de zinc nickelée, haute qualité, facile à monter

	cm	↑ cm	
04000	46 x 46	56	5-flammig / 5-lids / 5 ramas / 5 branches
04012	46 x 46	78	5-flammig / 5-lids / 5 ramas / 5 branches



**Kerzenleuchter**

candle holder  
candelabro  
chandelier



hochwertige Gastro Ausführung, möbelschonende Unterseite  
heavy quality, with non-scratching undersurface  
alta calidad, con base anti raya duras  
haute qualité, avec revêtement antirayures

	cm	↑ cm	
04001	27,5 x 27,5	25	5-flammig / 5-lids / 5 ramas / 5 branches
04002	27,5 x 11,0	25	3-flammig / 3-lids / 3 ramas / 3 branches
	Ø cm	↑ cm	
04003	11	22	1-flammig / 1 lid / 1 rama / 1 branche
04004	11	10	1-flammig / 1 lid / 1 rama / 1 branche



**Kerzenleuchter „CLASSIC“, 2er Set**

candle holder, 2 pcs. set  
candelabros, set de 2  
chandeliers, set de 2



**möbelschonende Unterseite**  
with non-scratching undersurface  
con base anti rayaduras  
avec revêtement antirayures

	Ø cm	↑ cm	pcs.
04035	10	20,5	2



**Kerzenleuchter „CLASSIC“**

candle holder  
candelabro  
chandelier



**möbelschonende Unterseite**  
with non-scratching undersurface  
con base anti rayaduras  
avec revêtement antirayures

	cm	↑ cm	
04036	22 x 10	22,5	3-flammig / 3-lids / 3 ramas / 3 branches



**Kerzenleuchter „CLASSIC“**

candle holder  
candelabros  
chandelier



**möbelschonende Unterseite**  
with non-scratching undersurface  
con base anti rayaduras  
avec revêtement antirayures

	cm	↑ cm	
04037	22 x 22	24	5-flammig / 5-lids / 5 ramas / 5 branches



**Kerzenleuchter „XL“**

candle holder  
candelabro  
grand chandelier



**extra hoch und schwer, möbelschonende Unterseite**  
extra high and heavy, with non-scratching undersurface  
pesado y de alta calidad, con base anti rayaduras  
lourd et de haute qualité, avec revêtement antirayures

	cm	↑ cm	
04005	35 x 13	39	3-flammig / 3-lids / 3 ramas / 3 branches



**Kerzenleuchter „XL“**

candle holder  
candelabro  
grand chandelier



**extra hoch und schwer, möbelschonende Unterseite**  
extra high and heavy, with non-scratching undersurface  
pesado y de alta calidad, con base anti rayaduras  
lourd et de haute qualité, avec revêtement antirayures

	cm	↑ cm	
04006	35 x 35	39	5-flammig / 5-lids / 5 ramas / 5 branches



**Kerzenleuchter, 2er Set**

candle holder, 2 pcs. set  
candelabros, set de 2  
chandeliers, set de 2



**möbelschonende Unterseite**  
with non-scratching undersurface  
con base anti rayaduras  
avec revêtement antirayures

	Ø cm	↑ cm	pcs.
04008	6	7	2



**Kerzenleuchter**

candle holder  
candelabro  
chandelier



**extra schwerer Fuß, verchromt, möbelschonende Unterseite**  
heavy foot, chrome plated, with non-scratching undersurface  
pie pesado, asa cromado, con base anti rayaduras  
pied lourd, chromé, avec revêtement antirayures

	Ø cm	↑ cm	Farbe / Colour
04020	10	11	
04021	10	16	



**Kerzenleuchter**

candle holder  
candelabro  
chandelier



**Metall hartverchromt, 1-flammig, standsichere Ausführung**  
hard chrome plated metal, 1 lid, heavy stable quality  
metal duro cromado, 1 brazo, construcción estable  
metal chromé dur, 1 flamme, stable

	Ø cm	↑ cm
04030	9,5	10
04031	9,5	16



**Kerzenleuchter „ELEMENT“**

candle holder  
candelabro  
chandelier



**Beton, mit möbelschonender Unterseite**  
concrete, furniture-friendly underside  
hormigón, con base anti rayaduras  
béton, avec revêtement antirayures

	Ø cm	↑ cm
04027	10	14,5





**Windlichter, 2er Set**

wind lights, 2 pcs. set  
portavelas antiviento, set de 2  
porte-bougies anti-vent, set de 2



**matt poliert, Gläser satiniert, möbelschonende Unterseite**  
satin polished finish, glasses satin, with non-scratching undersurface  
pulido acabado efecto satinado, cristales satinados, con base anti rayaduras  
inox mat satiné et verre mat, avec revêtement antirayures

	Ø cm	↑ cm	pcs.
03020	5	15	2

Ersatzglas / spare glass / cristal de recambio / verre de rechange

03025



**Windlichter „ELEMENT“, 2er Set**

wind lights, 2 pcs. set  
portavelas antiviento, set de 2  
porte-bougies anti-vent, set de 2



**Beton, Gläser klar, mit möbelschonender Unterseite**  
concrete, glass clear, with non-scratching undersurface  
hormigón, vidrio transparente, con base anti rayaduras  
bèton, verre transparente, avec revêtement antirayures

	Ø cm	↑ cm	pcs.
03038	6	8	2

Ersatzglas / spare glass / vidrio de recambio solo / verre de rechange transparent, seul

	Ø cm	↑ cm
03098	6	5



**Windlicht „ELEMENT“**

wind light  
porta vela  
porte-bougie



**Beton, Glas klar, mit möbelschonender Unterseite**  
concrete, glass clear, with non-scratching undersurface  
hormigón, vidrio transparente, con base anti rayaduras  
bèton, verre transparente, avec revêtement antirayures

	Ø cm	↑ cm
03039	7,5	13

Ersatzglas / spare glass / vidrio de recambio solo / verre de rechange transparent, seul

	Ø cm	↑ cm
03099	7,5	9



**Windlicht / Tischleuchte**

wind light  
porta velas  
porte-bougie de table, anti-vent



**möbelschonende Unterseite**  
with non-scratching undersurface  
con base anti rayaduras  
avec revêtement antirayures

	Ø cm	↑ cm
03013	11	22

Ersatzglas / spare glass / vidrio de recambio solo / verre de rechange transparent, seul

03015



**Vase mit Glaseinsatz „ELEMENT“**

flower vase with glass insert  
 florero con tubo de cristal  
 vase soliflor avec verre



**Beton, Glas klar, mit möbelschonender Unterseite, inkl. 2 Ersatzgläsern**  
 concrete, clear glass, furniture-friendly underside, incl. 2 spare glasses  
 hormigón, cristal incoloro, con base anti rayaduras, incl. 2 tubos de repuesto  
 béton, verre transparente avec revêtement antirayures y compris 2 verres de rechange

	cm	↑ cm	ml
04010	10 x 4,5	12,5	25

**Ersatzglas / spare glass / tubo de recambio / verre de rechange**

	Ø cm	↑ cm	ml
04011	2,5	11	25



**Vase**

flower vase  
 florero  
 vase soliflor



**Edelstahl-Look, Zinkdruckguss, vernickelt, lackiert, anlaufgeschützt, schwere Ausführung**  
 stainless steel look, heavy zink alloy, nickel plated, laquered  
 aspecto acero, acabado satinado, alta calidad  
 aspect inox, fini mat satiné, bonne qualité

	Ø cm	↑ cm	kg
04015	4,0	16,5	0,17
04016	4,5	20,0	0,20



**Vase**

flower vase  
 florero  
 vase soliflor



**Edelstahl-Look, Zinkdruckguss, vernickelt, lackiert, anlaufgeschützt, schwere Ausführung**  
 stainless steel look, heavy zink alloy, nickel plated, laquered  
 aspecto acero, acabado satinado, alta calidad  
 aspect inox, fini mat satiné, bonne qualité

	Ø cm	↑ cm	kg
04017	6,5	18	0,36

# Tischsets



Die umgelegten und angenähten Kanten machen diese Tischsets besonders robust. Geliefert in einer 6er Einheit.

The folded and sewn edges make these table sets particularly robust. Delivered in a packing unit of 6 pieces.

Los bordes doblados y cosidos des los mantelitos los hacen especialmente resistentes. Se entregan en una unidad de embalaje de 6 piezas.

Les bords repliés et cousus rendent ces sets de table en particulièrement robustes. Livré dans un emballage de 6 pièces.



## Warenträger - Tischsets

display for table sets  
expositor para mantelinas de mesa  
présentoir pour sets de table

**12 Einschubfächer, komplett auf Rollen, 2 Feststellrollen, Lieferung demontiert**

12 shelves, on rolls, 2 rolls to fix, delivery unassembled  
12 niveles, 4 ruedas, desmontado (montaje fácil)  
12 niveaux, 4 roues, livré démonté

	cm	↑ cm
00401	39,5 x 45	165



## Tischset Feinband

placemat fine band  
mantelín cinta fina  
set de table, tressage fin



	cm		VE / unit
60037	45 x 33	gold / gold	6
60038	45 x 33	beige braun / beige brown	6
60040	45 x 33	blau / blue	6

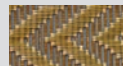

60037 - gold

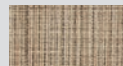

60038 - beige brown



60040 - blue



## Tischset Feinband „TAO“

placemat fine band  
mantelín cinta fina  
set de table, tressage fin



	cm		VE / unit
60502	45 x 33	grau, beige / grey, beige	6
60503	45 x 33	beige / beige	6
60505	45 x 33	braun / brown	6



60502 - grey, beige



60503 - beige



60505 - brown

## Tableware . Table Presentation



### Tischset „KUNSTLEDER“

placemat  
mantelín  
set de table



**Kunstleder**  
imitation leather  
imitación de cuero  
similicuir

	cm		VE / unit
60044	45 x 32,5	grau / grey	6
60045	45 x 32,5	braun / brown	6
60046	45 x 32,5	schwarz / black	6

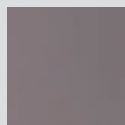

60044 - grey

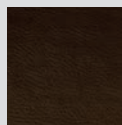

60045 - brown

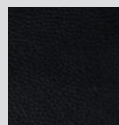

60046 - black



mit Naht rundherum

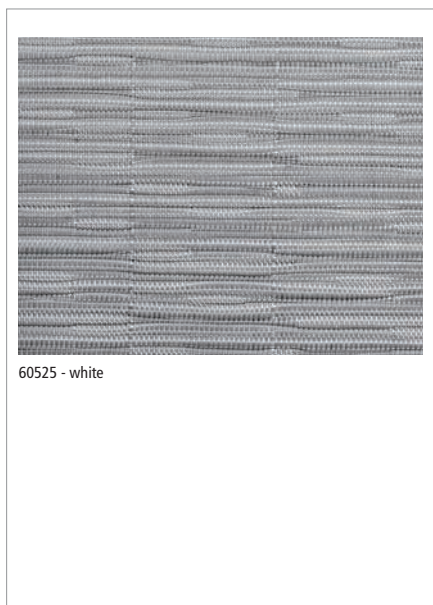

### Tischset Schmalband

placemat smallband  
mantelín cinta estrecha  
set de table tressage étroit



	cm		VE / unit
60525	45 x 33	weiß / white /	6
60526	45 x 33	gold / gold /	6
60527	45 x 33	silber / silver /	6
60528	45 x 33	grün / green /	6



60525 - white

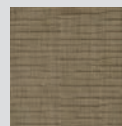

60526 - gold

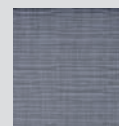

60527 - silver

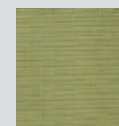

60528 - green

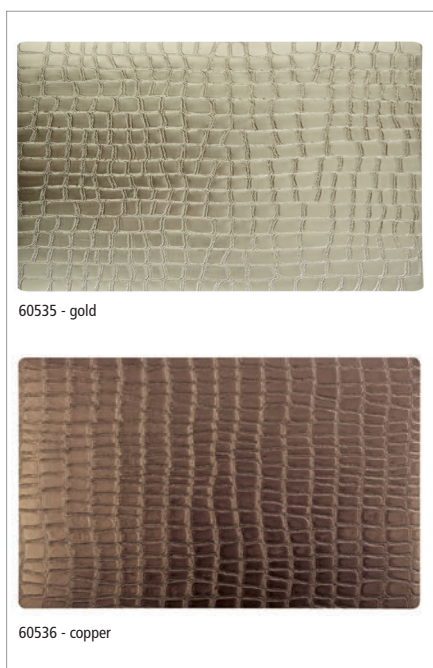

### Tischset „CROCO“

placemat  
mantelín  
set de table



**rutschhemmende Unterseite**  
slip resistant underside  
antideslizante por debajo  
dessous antiglisse

	cm		VE / unit
60535	45 x 30	gold / gold	6
60536	45 x 30	kupfer / copper	6
60537	45 x 30	braun / brown	6



60535 - gold

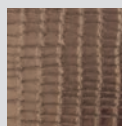

60536 - copper

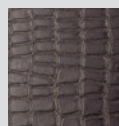

60537 - brown

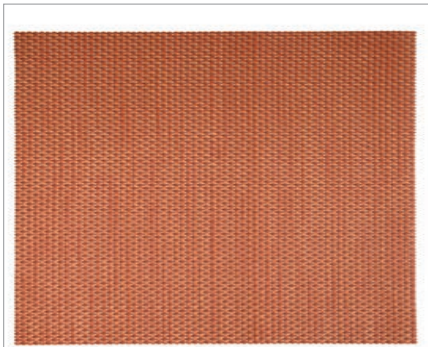

60018 - candyred

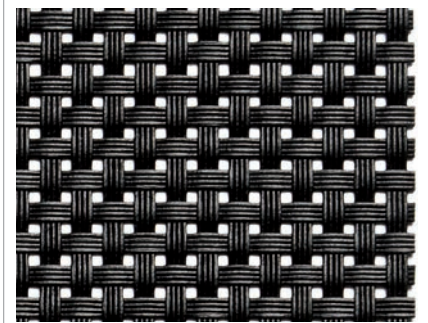

60012 - black

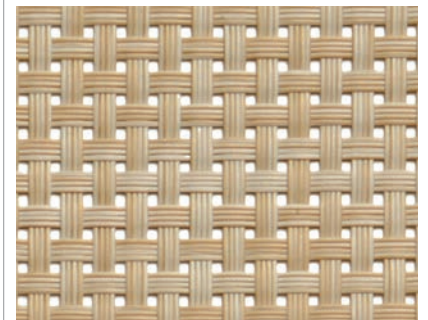

60014 - beige

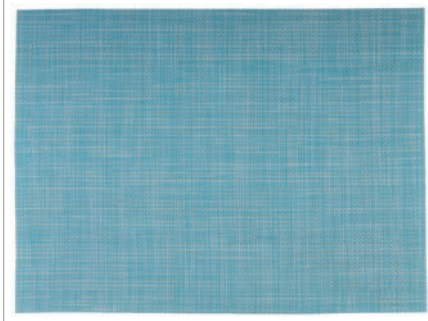

60041 - light blue, white



60042 - turquoise, green, white

Tischset Schmalband  
placemat smallband  
mantelín cinta estrecha  
set de table tressage étroit



	cm		VE / unit
60002	45 x 33	hellblau / light blue	6
60018	45 x 33	candyrot / candyred	6
60012	45 x 33	schwarz / black	6
60014	45 x 33	beige / beige	6
60015	45 x 33	silbergrau / silvergrey	6
60016	45 x 33	grün / green	6
60019	45 x 33	beige braun / beige brown	6
60522	45 x 33	hellorange / light orange	6
60520	45 x 33	schwarz weiß / black white	6
60521	45 x 33	apfelgrün / apple green	6
60523	45 x 33	violett / purple	6
60524	45 x 33	platin / platinum	6
60041	45 x 33	hellblau, weiß / light blue, white	6



60002 - light blue    60018 - candyred    60012 - black    60014 - beige    60015 - silvergrey    60016 - green  
 60019 - beige brown    60522 - light orange    60520 - black white    60521 - apple green    60523 - purple    60524 - platinum  
 60041 - light blue, white

Tischset Feinband  
placemat fine band  
mantelín cinta fina  
set de table, tressage fin



	cm		VE / unit
60042	45 x 33	türkis, grün, weiß / turquoise, green, white	6
60509	45 x 33	Mosaik schwarz, grau / black, grey	6
60512	45 x 33	schwarz, grau / black, grey	6
60542	45 x 33	rot / red	6

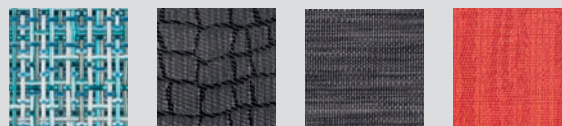

60042 - turquoise, green, white    60509 - black, grey    60512 - black, grey    60542 - red

## Tableware . Table Presentation

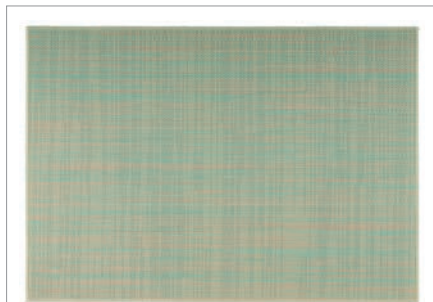

60506 - beige, turquoise



60507 - yellow, light blue

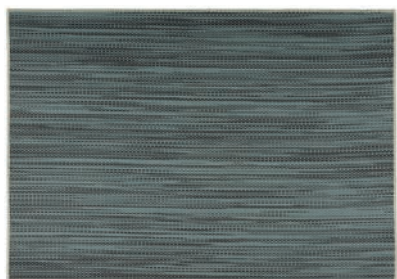

60508 - light blue, dark blue

### Tischset Feinband „TAO“

placemat fine band  
mantelín cinta fina  
set de table, tressage fin



	cm		VE / unit
60506	45 x 33	beige, türkis / beige, turquoise	6
60507	45 x 33	gelb, hellblau / yellow, light blue	6
60508	45 x 33	hellblau, dunkelblau / light blue, dark blue	6



60506 - beige, turquoise



60507 - yellow, light blue

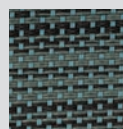

60508 - light blue, dark blue

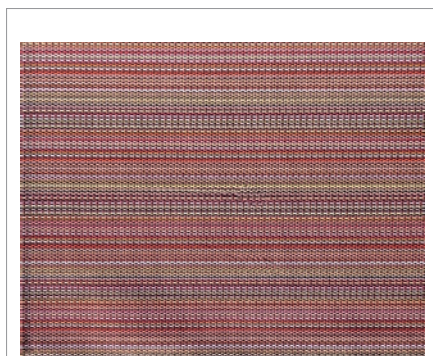

60510 - LINES orange red



60511 - LINES orange, yellow

### Tischset Feinband

placemat fine band  
mantelín cinta fina  
set de table, tressage fin



	cm		VE / unit
60510	45 x 33	LINES orange, rot / LINES orange red	6
60511	45 x 33	LINES orange, gelb / LINES orange yellow	6
60531	45 x 33	LINES schwarz / LINES black	6
60532	45 x 33	LINES pastell / LINES pastell	6
60533	45 x 33	LINES bordeaux / LINES bordeaux	6
60534	45 x 33	LINES rot / LINES red	6
60530	45 x 33	STRIPES grau / STRIPES grey	6
60540	45 x 33	FRAMES grau / FRAMES grey	6
60541	45 x 33	FRAMES schwarz / FRAMES black	6



60510 - LINES orange red



60511 - LINES orange, yellow

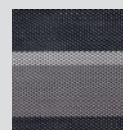

60531 - LINES black

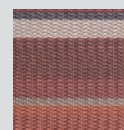

60532 - LINES pastell

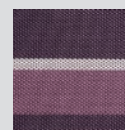

60533 - LINES bordeaux

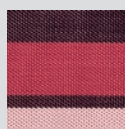

60534 - LINES red

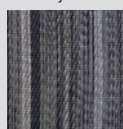

60530 - LINES grey

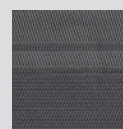

60540 - FRAMES grey

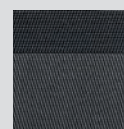

60541 - FRAMES black

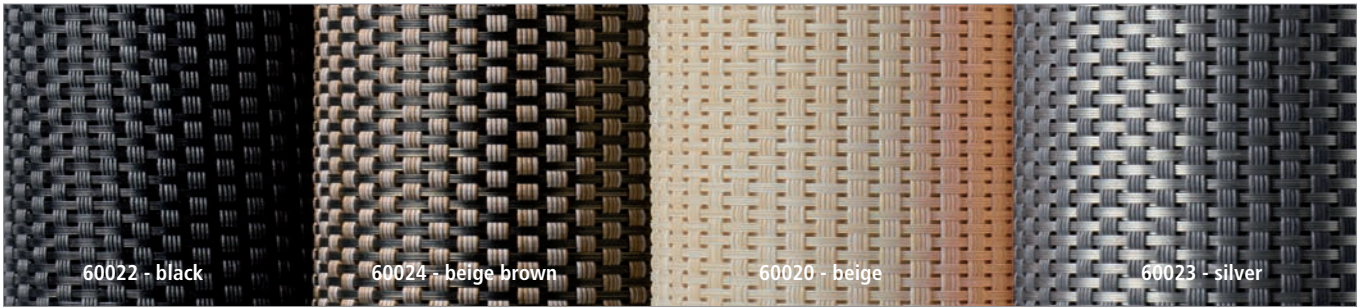

**Schmalband Tischläufer**

table runner fine fabric  
camino de mesa  
chemin de table

pflegeleichtes Kunststoffgeflecht  
easy to clean  
fácil de limpiar  
nettoyage aisé



	cm		
60022	45 x 150		schwarz / black
60024	45 x 150		beige, braun / beige, brown
60020	45 x 150		beige / beige
60023	45 x 150		silbergrau / silver grey



**Servietten- und Bestecktaschen, 6er Set**

cutlery bag, 6 pcs. set  
bolsa cubiertos, set de 6  
pochette couverts, set de 6



	cm		pcs.
60551	24 x 9	silbergrau / silvergrey	6
60550	24 x 9	beige / beige	6
60552	24 x 9	beige braun / beige brown	6
60554	24 x 9	platin / platinum	6



60550 - beige

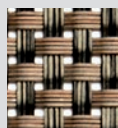

60552 - beige/braun

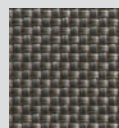

60554 - platin







# Körbe

baskets  
cestas  
corbeilles

# SUPERSTRONG



## GN 1/1 Korb „SUPERSTRONG“

GN 1/1 basket  
GN 1/1 cesta  
GN 1/1 corbeille



	cm	↑ cm	GN	Farbe / Colour
50640	53 x 32,5	6,5	1/1	
50641	53 x 32,5	10,0	1/1	
50642	53 x 32,5	15,0	1/1	
50643	53 x 32,5	6,5	1/1	
50644	53 x 32,5	10,0	1/1	
50645	53 x 32,5	15,0	1/1	

## GN Kuppelhaube / GN cover / GN cúpula / GN cloche bombée

	cm	↑ cm	GN
11027	54 x 33	20	1/1

## GN Abdeckhaube / GN cover / GN cubierta / GN cloche

	cm	↑ cm	GN
11042	53 x 32,5	9,5	1/1

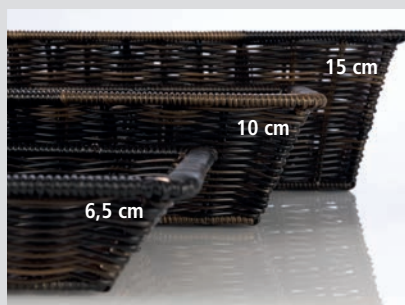

# PROFI LINE



Korb "PROFI LINE"  
basket baker size  
cesta tamaño panaderia  
corbeille dimensions „boul-pâte“



	cm	↑ cm	Farbe / Colour
50714	30 x 20	5	
50900	40 x 20	5	
50901	40 x 20	5	
50902	40 x 20	5	
50903	40 x 20	5	



Korb "PROFI LINE"  
basket baker size  
cesta tamaño panaderia  
corbeille dimensions „boul-pâte“



	cm	↑ cm	Farbe / Colour
50905	40 x 30	5	
50906	40 x 30	5	
50907	40 x 30	5	
50908	40 x 30	5	
	cm	↑ cm	Farbe / Colour
50710	40 x 30	10	
50711	40 x 30	10	
50713	40 x 30	10	
50712	40 x 30	10	



Korb "PROFI LINE"  
basket baker size  
cesta tamaño panaderia  
corbeille dimensions „boul-pâte“



	cm	↑ cm	Farbe / Colour
50910	60 x 20	5	
50911	60 x 20	5	
50912	60 x 20	5	
50913	60 x 20	5	

# Körbe

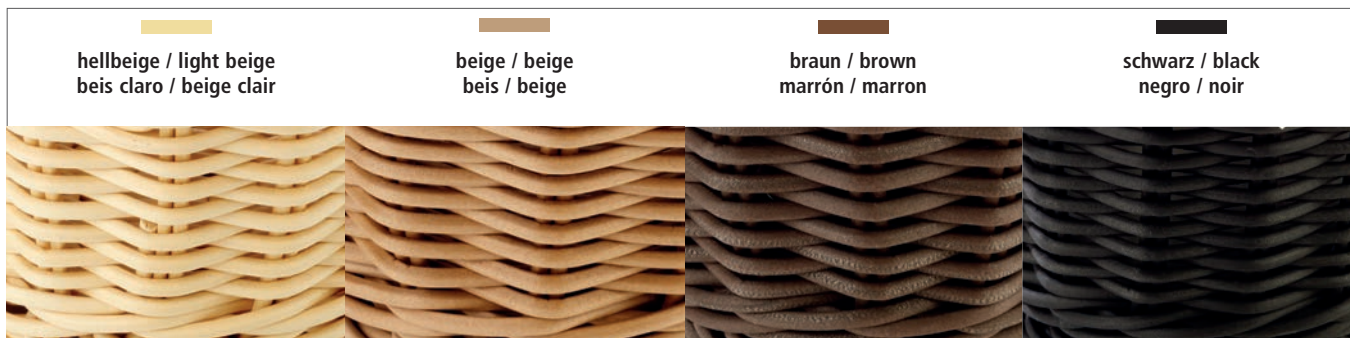

hellbeige / light beige  
beis claro / beige clair

beige / beige  
beis / beige

braun / brown  
marrón / marron

schwarz / black  
negro / noir



## Korb "PROFI LINE"

basket baker size  
cesta tamaño panaderia  
corbeille dimensions „boul-pâte“



	cm	↑ cm	Farbe / Colour
50915	60 x 40	5	hellbeige
50916	60 x 40	5	beige
50917	60 x 40	5	braun
50918	60 x 40	5	schwarz



## GN 1/1 Korb „PROFI LINE“

GN 1/1 basket  
GN 1/1 cesta  
GN 1/1 corbeille



	cm	↑ cm	Farbe / Colour
50720	53 x 32,5	10	hellbeige
50721	53 x 32,5	10	beige
50723	53 x 32,5	10	braun
50722	53 x 32,5	10	schwarz



## Korb, rechteckig „PROFI LINE“

basket, rectangular  
cesta, rectangular  
corbeille, rectangulaire



	cm	↑ cm	Farbe / Colour
50700	26,5 x 19	7	hellbeige
50701	26,5 x 19	7	beige
50703	26,5 x 19	7	braun
50702	26,5 x 19	7	schwarz

	cm	↑ cm	Farbe / Colour
50705	31 x 21	9	hellbeige
50706	31 x 21	9	beige
50708	31 x 21	9	braun
50707	31 x 21	9	schwarz



**Brötchenschütte „PROFI LINE“**

roll / bun basket  
cesta para bollos  
corbeille à petits pains



	cm	↑ cm
50510	60 x 40	60



**Stangenbrotkorb „PROFI LINE“**

baguette basket  
cesta de baguette  
corbeille à baguettes



	Ø cm	↑ cm	Farbe / Colour
50500	28 / 30	38	Yellow
50501	28 / 30	38	Brown



**Auslage Tablett flach „PROFI LINE“**

display tray flat, baker size  
bandeja de presentación, tamaño panadería  
plateau de présentation, dimensions „boul-pâte“



	cm	↑ cm
40296	40 x 30	1
40297	60 x 40	1

## Körbe



### Korb, rund „PROFI LINE“

basket, round  
cesta redonda  
corbeille ronde



	∅ cm	↑ cm
50210	37	9
50215	42	12



### Korb, rund „PROFI LINE“

basket, round  
cesta redonda  
corbeille ronde



	∅ cm	↑ cm
50205	31 / 37	12 / 6



### Korbschütte, rund „PROFI LINE“

basket, round  
cesta redonda  
corbeille ronde



	∅ cm	↑ cm
50100	36,5	12,0
50105	42,0	18,5
50110	46,0	18,5



### Systemkorb, gestäbt „PROFI LINE“

basket  
cesta  
corbeille



	cm	↑ cm
50300	30 x 40	27 / 16
50305	45 x 40	27 / 16
50310	60 x 40	27 / 16



### Systemkorb „PROFI LINE“

basket  
cesta  
corbeille



	cm	↑ cm
50400	40 x 50	25 / 14



### Trenner „PROFI LINE“

divider  
divisor  
paroi de séparation



	↑ cm	→ cm
50315	26 / 15	38



**Baguette Korb, oval „PROFI LINE“**

baguette basket, oval  
cesta de baguette, oval  
corbeille à baguettes, ovale



	cm	↑ cm	Farbe / Colour
50805	28 x 16	8	
50806	28 x 16	8	
50808	28 x 16	8	
50807	28 x 16	8	

	cm	↑ cm	Farbe / Colour
50823	40 x 16	8	



**Korb, oval „PROFI LINE“**

basket, oval  
cesta oval  
corbeille ovale



	cm	↑ cm	Farbe / Colour
50800	25 x 19	6,5	
50801	25 x 19	6,5	
50803	25 x 19	6,5	
50802	25 x 19	6,5	

	cm	↑ cm	Farbe / Colour
50815	32 x 23	7	
50816	32 x 23	7	
50818	32 x 23	7	
50817	32 x 23	7	



**Korb, rund „PROFI LINE“**

basket, round  
cesta redonda  
corbeille ronde



	Ø cm	↑ cm	Farbe / Colour
50600	16	8	
50601	16	8	
50603	16	8	
50602	16	8	

	Ø cm	↑ cm	Farbe / Colour
50605	20	8	
50606	20	8	
50608	20	8	
50607	20	8	

	Ø cm	↑ cm	Farbe / Colour
50610	29	7	
50611	29	7	
50613	29	7	
50612	29	7	

# Körbe



## Korb, oval „PROFI LINE“

basket, oval  
cesta, oval  
corbeille, ovale



	cm	↑ cm	Farbe / Colour
50624	19 x 12	6	
50625	19 x 12	6	
50627	19 x 12	6	
50626	19 x 12	6	



## Korb, rechteckig „PROFI LINE“

basket, rectangular  
cesta rectangular  
corbeille rectangulaire



	cm	↑ cm	Farbe / Colour
50632	17 x 11	9	
50633	17 x 11	9	
50635	17 x 11	9	
50634	17 x 11	9	

	cm	↑ cm	Farbe / Colour
50628	19 x 13	6	
50629	19 x 13	6	
50631	19 x 13	6	
50630	19 x 13	6	



## Korb, rund „PROFI LINE“

basket, round  
cesta, redonda  
corbeille, ronde



	Ø cm	↑ cm	Farbe / Colour
50620	13	10	
50621	13	10	
50623	13	10	
50622	13	10	



# GN LINE

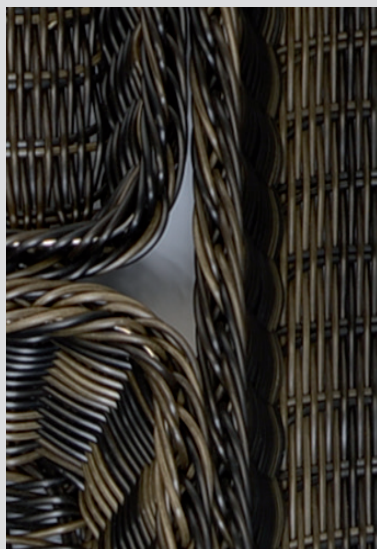

2 Höhen - 6,5 und 10 cm  
2 heights - 6,5 and 10 cm



40293  
GN 1/1 - 10 cm



40292  
GN 1/2 - 10 cm

40225  
GN 1/4 - 6,5 cm

## Korb „GN LINE“

GN basket  
GN cesta  
GN corbeille



stabile Ausführung mit Edelstahldraht im Rand zur Stabilisierung  
very solid with stainless steel wire frame to stabilize the basket  
muy resistente con refuerzo de alambre inox  
très résistante avec son fil de renfort inox

	cm	↑ cm	GN	Farbe / Colour
40291	53,0 x 32,5	6,5	1/1	■ ■
40290	32,5 x 26,5	6,5	1/2	■ ■
40223	32,5 x 17,6	6,5	1/3	■ ■
40225	26,5 x 16,2	6,5	1/4	■ ■
40227	17,6 x 16,2	6,5	1/6	■ ■
40229	32,5 x 35,4	6,5	2/3	■ ■

	cm	↑ cm	GN	Farbe / Colour
40293	53,0 x 32,5	10,0	1/1	■ ■
40292	32,5 x 26,5	10,0	1/2	■ ■
40243	32,5 x 17,6	10,0	1/3	■ ■
40245	26,5 x 16,2	10,0	1/4	■ ■
40247	17,6 x 16,2	10,0	1/6	■ ■
40249	32,5 x 35,4	10,0	2/3	■ ■



GN 1/1

## GN 1/1 Besteckbehälter

GN 1/1 dispenser GN  
GN 1/1 dispensador de cubiertos  
GN 1/1 bac à couverts



in Handarbeit geflochten, 4 Mulden, Kunststoff-Geflecht, Drahtgestell, braun-schwarz  
wickerwork, 4 compartments, with reinforced chromed wire structure, brown-black  
cesta trensada a mano, 4 compartimentos, de plástico, con bastidor cromado reforzado, marrón oscuro  
corbeille tressée à main, 4 compartiments, en plastique, cadre acier chromé renforcé, couleur marron foncé

	cm	↑ cm	GN	Farbe / Colour
11966	53 x 32,5	9	1/1	■ ■

# GN LINE

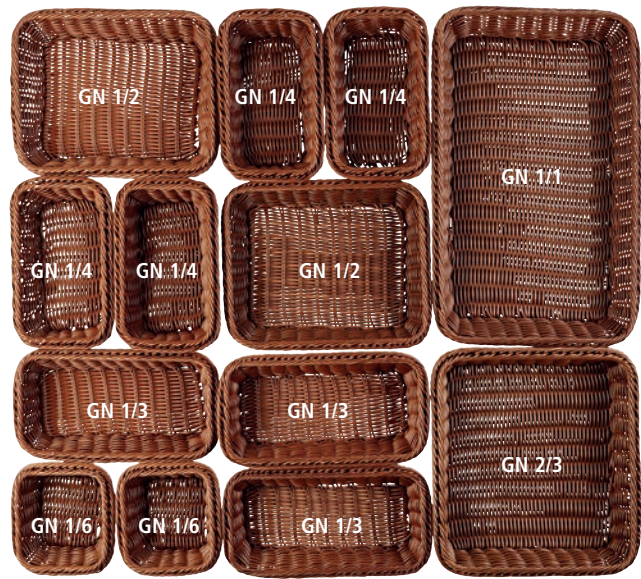
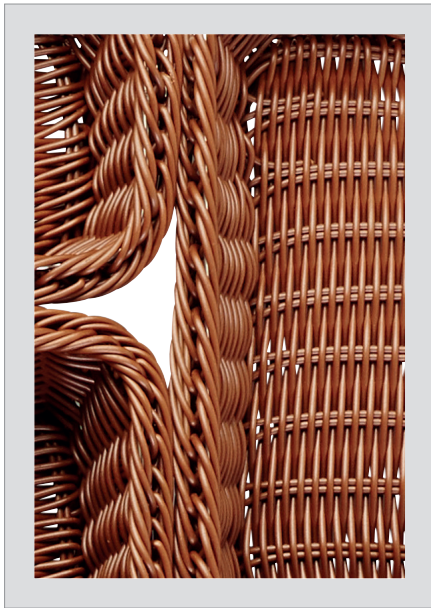

2 Höhen - 6,5 und 10 cm  
2 heights - 6,5 and 10 cm



40220  
GN 1/1 - 6,5 cm



40222  
GN 1/2 - 6,5 cm



40228  
GN 1/6 - 6,5 cm



40272  
GN 1/2 - 10 cm



40264  
GN 1/4 - 6,5 cm



40272  
GN 1/2 - 10 cm

## Korb „GN LINE“

GN basket  
GN cesta  
GN corbeille



stabile Ausführung mit Edelstahldraht im Rand zur Stabilisierung  
very solid with stainless steel wire frame to stabilize the basket  
muy resistente con refuerzo de alambre inox  
très résistante avec son fil de renfort inox

	cm	↑ cm	GN	Farbe / Colour
40220	53,0 x 32,5	6,5	1/1	
40222	32,5 x 26,5	6,5	1/2	
40224	32,5 x 17,6	6,5	1/3	
40226	26,5 x 16,2	6,5	1/4	
40228	17,6 x 16,2	6,5	1/6	
40230	32,5 x 35,4	6,5	2/3	

	cm	↑ cm	GN	Farbe / Colour
40240	53,0 x 32,5	10	1/1	
40242	32,5 x 26,5	10	1/2	
40244	32,5 x 17,6	10	1/3	
40246	26,5 x 16,2	10	1/4	
40248	17,6 x 16,2	10	1/6	
40250	32,5 x 35,4	10	2/3	

	cm	↑ cm	GN	Farbe / Colour
40260	53,0 x 32,5	6,5	1/1	
40262	32,5 x 26,5	6,5	1/2	
40263	32,5 x 17,6	6,5	1/3	
40264	26,5 x 16,2	6,5	1/4	
40266	17,6 x 16,2	6,5	1/6	
40268	32,5 x 35,4	6,5	2/3	

	cm	↑ cm	GN	Farbe / Colour
40270	53,0 x 32,5	10	1/1	
40272	32,5 x 26,5	10	1/2	
40274	32,5 x 17,6	10	1/3	
40276	26,5 x 16,2	10	1/4	
40278	17,6 x 16,2	10	1/6	
40280	32,5 x 35,4	10	2/3	

# ECONOMIC



## Tisch- und Buffetkorb, rund „ECONOMIC“

buffet basket, round  
cesta de buffet, redonda  
corbeille de buffet, ronde



	Ø cm	↑ cm	Farbe / Colour
40132	19,0	9,5	
40135	25,5	8,5	
40144	39,0	10,0	
40191	19,0	9,5	
40192	25,5	8,5	



## Tisch- und Buffetkorb, oval „ECONOMIC“

buffet basket, oval  
cesta de buffet, oval  
corbeille de buffet, ovale



	cm	↑ cm	Farbe / Colour
40137	23,0 x 17	8,0	
40139	28,5 x 17	8,5	
40193	23,0 x 17	8,0	
40194	28,5 x 17	8,5	



## Tisch- und Buffetkorb, eckig „ECONOMIC“

buffet basket, rectangular  
cesta de buffet, rectangular  
corbeille de buffet, rectangulaire



	cm	↑ cm	Farbe / Colour
40140	23,0 x 17	8	
40159	31,5 x 22	8,5	
40195	23,0 x 17	8	
40196	31,5 x 22	8,5	



## GN Buffetkorb „ECONOMIC“

GN basket  
GN cesta  
GN corbeille



	cm	↑ cm	GN	Farbe / Colour
40148	53 x 32,5	8	1/1	



## GN Buffetkorb „ECONOMIC“

GN basket  
GN cesta  
GN corbeille



	cm	↑ cm	GN	Farbe / Colour
40152	32,5 x 26,5	8	1/2	

# Körbe



## Buffetkorb „ECONOMIC“

buffet basket  
cesta de buffet  
corbeille de buffet



**stabile Ausführung mit Edelstahldraht im Rand zur Stabilisierung**

very solid with stainless steel wire frame to stabilize the basket

muy resistente con refuerzo de alambre inox

très résistante avec son fil de renfort inox

	cm	↑ cm	GN
40129	53 x 32,5	15,5	1/1

**GN Kuppelhaube / GN cover / GN cúpula / GN cloche bombée**

	cm	↑ cm
11027	54 x 33	20



## Buffetkorb „ECONOMIC“

buffet basket  
cesta de buffet  
corbeille de buffet



**stabile Ausführung mit Edelstahldraht im Rand zur Stabilisierung**

very solid with stainless steel wire frame to stabilize the basket

muy resistente con refuerzo de alambre inox

très résistante avec son fil de renfort inox

	cm	↑ cm
40153	45 x 42	17 / 24



## Buffetkorb, rund „ECONOMIC“

buffet basket, round  
cesta de buffet, redonda  
corbeille de buffet ronde



**stabile Ausführung mit Edelstahldraht im Rand zur Stabilisierung**

very solid with stainless steel wire frame to stabilize the basket

muy resistente con refuerzo de alambre inox

très résistante avec son fil de renfort inox

	Ø cm	↑ cm	Farbe / Colour
40149	40	12,5	Yellow
40295	40	12,5	Black

**Rolltophaube / rolltop cover / campana abatible / cloche basculante**

	Ø cm	↑ cm	
18388	38	20	mit verchromtem Kugelgriff with chrome plated handle con pomo cromado / avec bouton chromé
18387	38	20	mit vergoldetem Kugelgriff / gold plated handle pomo dorado / bouton doré
18389	38	20	mit verchromtem Designergriff / with chrome plated designer handle



**Buffetkorb „ECONOMIC“**

buffet basket  
cesta de buffet  
corbeille buffet



in Handarbeit geflochten, stabile Ausführung, Edelstahl Fixierungsrahmen, zur Rutschsicherung, ohne Haube

wickerwork, stainless steel fix the cover, without cover

cesta trensada a mano, con marco cromado patentado para fijar y encajar la campana (se entrega sin la campana)

corbeille tressée main, cadre fil acier inoxydable pour fixer la cloche (livré sans la cloche)

	cm	↑ cm	Farbe / Colour
40150	56,5 x 36	10	
40294	56,5 x 36	10	

GN 1/1 Rolltop-Haube / GN 1/1 rolltop cover / GN 1/1 campana abatible  
GN 1/1 cloche basculante

	cm	↑ cm	GN	
11008	53 x 32,5	19	1/1	vergoldeter Griff / gold plated handle pomo dorado / bouton doré
11010	53 x 32,5	19	1/1	verchromter Griff / chrome plated handle pomo cromado / bouton chromé
11018	53 x 32,5	17	1/1	mit verchromtem Designergriff with chrome plated designer handle



**GN Kuppelhaube**

GN cover  
GN cúpula  
GN cloche bombée



glasklarer Kunststoff, Griff verchromt

clear, chrome knob

transparente, asa cromada

transparente, anse chromée

	cm	↑ cm	GN	
11021	33 x 28	17	1/2	geschlossen / totally closed cerrada / tolement fermée
11022	33 x 28	17	1/2	mit Front-Ausschnitt / one long side cut out gran apertura frontal / grande ouverture frontale
11026	54 x 33	20	1/1	geschlossen / totally closed cerrada / tolement fermée
11027	54 x 33	20	1/1	mit Front-Ausschnitt / one long side cut out gran apertura frontal / grande ouverture frontale
11028	54 x 33	20	1/1	mit seitlichem Ausschnitt one small side cut out pequeña apertura lateral / petite ouverture latérale



**GN Abdeckhaube**

GN cover  
GN cubierta  
GN cloche



passend für GN Tablett, glasklarer Kunststoff, nahezu unzerbrechlich

suitable for GN trays, clear plastic, nearly unbreakable

apto para bandejas GN, plástico transparente, muy resistente a la rotura

pour bacs et plateaux GN, plastique transparent, très résistant à la casse



	cm	↑ cm	mm	GN
11043	32,5 x 17,6	10,5	3	1/3
11044	53,0 x 16,2	10,5	3	2/4

	cm	↑ cm	mm	GN
11041	32,5 x 26,5	9,5	3	1/2
11042	53,0 x 32,5	9,5	3	1/1

# Körbe



## Buffetgestell für Körbe

buffet stand for baskets  
expositor para cestas  
support pour corbeilles



2-stufig, für 2 rechteckige Körbe, platzsparend zusammenklappbar, Lieferung ohne Körbe

2-tier, for 2 rectangular baskets, can be folded, place saving, delivery without baskets

2 alturas, para 2 cestas rectangulares, totalmente plegable para ahorrar espacio, se entrega sin cestas

2 hauteurs, pour 2 corbeilles rectangulaires, pliable pour son rangement, livré sans corbeilles

	cm	↑ cm
33221	46 x 24	18 - 21

Tisch- und Buffetkorb rechteckig „BASIC“ / buffet basket, square / cesta de buffet, cuadrada / corbeille de buffet, carré

	cm	↑ cm	Farbe / Colour
30286	30 x 22	7	
30288	40 x 29	7	

Tisch- und Buffetkorb, eckig „ECONOMIC“ / buffet basket rectangular / cesta de buffet, rectangular / corbeille de buffet rectangulaire

	cm	↑ cm	Farbe / Colour
40159	31,5 x 22	8,5	

Korb „GN LINE“ / GN basket / GN cesta / GN corbeille

	cm	↑ cm	Farbe / Colour
40222	32,5 x 26,5	6,5	
40242	32,5 x 26,5	10,0	
40262	32,5 x 26,5	6,5	
40272	32,5 x 26,5	10,0	



## Buffetgestell „DOPPELDECKER“ für GN

buffet frame for GN  
estructura para buffet para GN  
support buffet pour GN



2-teilig, einfach zusammensetzbar, Etagen-Abstand ca. 26 cm, platzsparend, stabile Ausführung

2 pcs., easy to assemble, distance between the tiers approx. 26 cm, space-saving, robust

2 pzas, fácil de montar, distancia entre pisos aprox. 26 cm, robusto

2 pcs, assemblage facile, distance entre niveaux approx. 26 cm, robuste

	cm	↑ cm	fits to GN
11555	50 x 34	37,5	1/1
11553	29 x 27	35,0	1/2





### Buffetgestell

buffet stand  
soporte para buffet  
présentoir buffet



3-stufig, geeignet für runde und rechteckige Körbe, platzsparend zusammenklappbar  
3-tier, usable for round and rectangular baskets, can be pushed together for place saving  
3 alturas, apto para cestas redondas y rectangulares, se puede plegar para ahorrar espacio  
3 hauteurs, pour corbeilles rondes ou rectang, la structure s'ouvre ou se ferme pour réduire l'encombrement

	cm	↑ cm
33232	59 x 30,5	59

### Tisch- und Buffetkorb, rund „ECONOMIC“ / buffet basket, round / cesta de bufé redonda / corbeille de buffet ronde

	Ø cm	↑ cm	Farbe / Colour
40144	39	10	



### Baguettekorb „ECONOMIC“

baguette basket  
cesta para baguette  
corbeille pour baguettes



stabile Ausführung mit Edelstahldraht im Rand zur Stabilisierung  
very solid with stainless steel wire frame to stabilize the basket  
muy resistente con refuerzo de alambre inox  
très résistante avec son fil de renfort inox

	Ø cm	↑ cm	Farbe / Colour
40198	35	24 / 42	

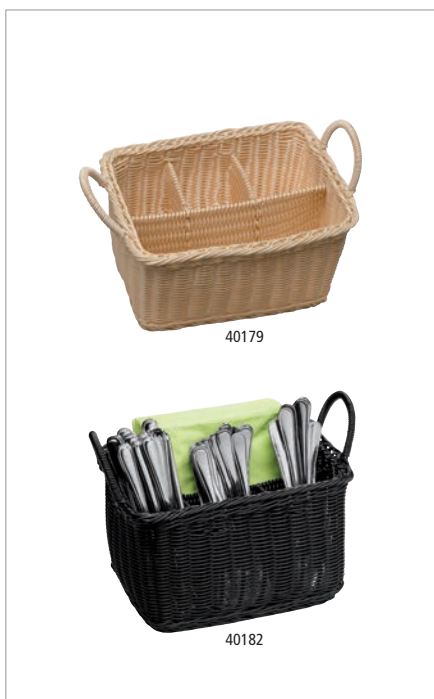

### Besteckkorb „ECONOMIC“

cutlery dispenser  
dispensador de cubiertos  
corbeille à couverts



4 Fächer, 3 kleine Fächer, 1 großes Fach  
4 troughs  
4 huecos  
4 classements

	cm	↑ cm	Farbe / Colour
40179	26 x 18	15	
40182	26 x 18	15	

# Körbe



## Brot- und Obstkorb „WICKER LOOK“

basket for bread or fruits  
cesta para pan o fruta  
corbeille à pain ou à fruits



	Ø cm	↑ cm	Farbe / Colour
40214	20	6,5	■
40216	23 x 17	6,5	■

	cm	↑ cm	Farbe / Colour
40211	39,5 x 29,5	10	■
40212	39,5 x 29,5	10	■
40210	39,5 x 29,5	10	■



## Besteckkorb „ECONOMIC“

cutlery dispenser  
dispensador de cubiertos  
corbeille à couverts



in Handarbeit geflochten  
wickerwork  
trensado a mano  
tressage à main

	Ø cm	↑ cm	Farbe / Colour
40130	12	15	■
40007	12	15	■
40012	12	15	■
40013	12	15	■



## Besteckkorb „ECONOMIC“

cutlery dispenser  
dispensador de cubiertos  
corbeille à couverts



in Handarbeit geflochten  
wickerwork  
trensado a mano  
tressage à main

	cm	↑ cm	Farbe / Colour
40131	27 x 10	4,5	■
40009	27 x 10	4,5	■
40010	27 x 10	4,5	■
40011	27 x 10	4,5	■





- in Handarbeit geflochten, einfache und leichte Ausführung
- wickerwork, simple and light version
- ligera, trensada a mano
- tressé à main, version légère



**Brot- und Obstkorb oval „BASIC“**  
 basket for bread or fruits  
 cesta para pan o fruta  
 corbeille à pain ou à fruits



	cm	↑ cm
30279	18 x 12	7
30280	23 x 15	6



**Brot- und Obstkorb oval „BASIC“**  
 basket for bread or fruits  
 cesta para pan o fruta  
 corbeille à pain ou à fruits



	cm	↑ cm
30282	21 x 10	6
30284	36 x 15	7



**Brot- und Obstkorb rund „BASIC“**  
 basket for bread or fruits  
 cesta para pan o fruta  
 corbeille à pain ou à fruits



	Ø cm	↑ cm
30281	20	7
30285	25	7



**Tisch- und Buffetkorb rechteckig „BASIC“**  
 buffet basket  
 cesta de buffet  
 corbeille de buffet



	cm	↑ cm
30286	30 x 22	7
30288	41 x 29	7
30283	22 x 15	6



**Brot- und Obstkorb quadratisch „BASIC“**  
 basket for bread or fruits  
 cesta para pan o fruta  
 corbeille à pain ou à fruits



	cm	↑ cm
30287	24 x 24	6

# Brottasche

Umgekrempelt kann die Höhe individuell gestaltet werden!



## Brottasche bread basket panera corbeille



70% Naturfaser und 30% Kunstharz  
70% natural fibre and 30% synthetic resin  
70% fibra natural y 30% resina sintética  
70% de fibres naturelles et 30% de résine synthétique

	Ø cm	↑ cm	Farbe / Colour
30440	17	11	■
30450	20	13	■
30442	24	24	■
30443	30	22	■
30441	17	11	■
30451	20	13	■
30445	24	24	■
30446	30	22	■



## Brottasche bread basket panera corbeille



70% Naturfaser und 30% Kunstharz  
70% natural fibre and 30% synthetic resin  
70% fibra natural y 30% resina sintética  
70% de fibres naturelles et 30% de résine synthétique

	cm	↑ cm	Farbe / Colour
30444	30 x 20	18	■
30447	30 x 20	18	■

umgekrempelt kann die Höhe individuell gestaltet werden  
adjustable height by turning the edge upside down  
altura ajustable girando el borde al revés  
hauteur ajustable en tournant le bord à l'envers

NEW



30355



30356

**Brottasche**

bread basket  
panera  
corbeille



70% Naturfaser und 30% Kunstharz  
70% natural fibre and 30% synthetic resin  
70% fibra natural y 30% resina sintética  
70% de fibres naturelles et 30% de résine synthétique

	cm	↑ cm	Farbe / Colour
30355	12 x 11,5	11,5	
30356	12 x 11,5	13,5	



30355

umgekrempelt kann die Höhe individuell gestaltet werden  
adjustable height by turning the edge upside down  
altura ajustable girando el borde al revés  
hauteur ajustable en tournant le bord à l'envers

NEW



30345

rund



30346

rund

**Brottasche**

bread basket  
panera  
corbeille



	Ø cm	↑ cm	Farbe / Colour
30345	17	11,5	
30346	20	13,5	

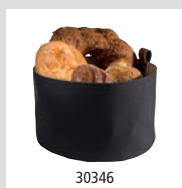

30346

schmutzabweisende Kunstfaser, 30°C waschbar  
dirt-repellent synthetic fibre, washable 30°C  
fibra sintética repelente a la suciedad, lavable a 30°C  
fibre synthétique anti-salissante, lavable à 30°C

NEW



30347



30348

**Brottasche**

bread basket  
panera  
corbeille



	cm	↑ cm	Farbe / Colour
30347	19 x 11	10,5	
30348	24 x 16	10,5	



30347

schmutzabweisende Kunstfaser, 30°C waschbar  
dirt-repellent synthetic fibre, washable 30°C  
fibra sintética repelente a la suciedad, lavable a 30°C  
fibre synthétique anti-salissante, lavable à 30°C

## Körbe



### Brottasche bread basket panera corbeille à pain en toile

BAUM-  
WOLLE  
COTTON

Baumwolle, umgekrempelt kann die Höhe individuell gestaltet werden, maschinenwaschbar bis 30°C, rund oder oval

cotton, adjustable height, mashine-washable 30°C, round or oval

algodón, altura ajustable, lavable a máquina 30°C, redondo u oval

coton, hauteur ajustable, lavable en machine maxi 30°C, rond ou ovale

	Ø cm	↑ cm	Farbe / Colour
30340	17	11	Yellow
30350	20	12	Yellow
30341	17	11	Black & Yellow
30351	20	12	Black & Yellow
30360	20 x 15	10	Yellow
30370	25 x 18	12	Yellow
30361	20 x 15	10	Black & Yellow
30371	25 x 18	12	Black & Yellow



### Brottasche mit Wärmekissen bread basket with stones pillow panera con cojín corbeille à pain en toile avec coussin chauffant

BAUM-  
WOLLE  
COTTON

Baumwolle, Keramik-Kugeln, maschinenwaschbar bis 30°C

cotton, ceramic stones, mashine-washable 30°C

algodón, bolas de cerámica, lavable a máquina 30°C

coton, billes de céramiques, lavable en machine maxi 30°C

	Ø cm	↑ cm	Farbe / Colour
30380	19	23	Yellow
30390	19	23	Yellow & Brown

Wärmekissen / stones pillow / cojín de piedrecillas a calentar / coussin de petites pierres, à chauffer

	Ø cm	↑ cm
30385	19	1,5



### Eierkorb „PROFI LINE“

egg basket  
cesta de huevos  
panier à oeufs

PP  
POLYPROPYLEN

EDELSTAHL  
STAINLESS  
INOX

mit Edelstahldraht im Rand, für ca. 20 Eier, hält den Inhalt durch das Stoff-Futter lange warm

willow, stable, for around 20 eggs, keeps eggs warm

ratán, calidad fuerte, para unos 20 huevos, mantiene los huevos calientes

rotin, résistant, belle qualité, pour environ 20 oeufs, pour maintenir les oeufs bien chauds

	Ø cm	↑ cm	Farbe / Colour
40299	26	17	Black & Brown



### Eierkorb

egg basket  
cesta de huevos  
panier à oeufs

RATTAN  
NATUR

stabile Vollweide, für ca. 20 Eier, hält den Inhalt durch das Stoff-Futter lange warm

willow, stable, for around 20 eggs, keeps eggs warm

ratán, calidad fuerte, para unos 20 huevos, mantiene los huevos calientes

rotin, résistant, belle qualité, pour environ 20 oeufs, pour maintenir les oeufs bien chauds

	Ø cm	↑ cm	Farbe / Colour
30299	26	17	Yellow



Schale

bowl  
cuenco  
bol



gehämmerte Oberfläche  
hammered (surface)  
superficie martillada  
surface martelée

	cm	↑ cm	ltr.	Farbe / Colour
40690	15,5 x 12,0	5,5	0,7	gold look
40693	23,0 x 15,5	6,0	1,4	gold look



Schale

bowl  
cuenco  
bol



gehämmerte Oberfläche  
hammered (surface)  
superficie martillada  
surface martelée

	cm	↑ cm	ltr.	Farbe / Colour
40691	15,5 x 12,0	5,5	0,7	copper look
40694	23,0 x 15,5	6,0	1,4	copper look



Schale

bowl  
cuenco  
bol



gehämmerte Oberfläche  
hammered (surface)  
superficie martillada  
surface martelée

	cm	↑ cm	ltr.	Farbe / Colour
40692	15,5 x 12,0	5,5	0,7	gunmetal-look
40695	23,0 x 15,5	6,0	1,4	gunmetal-look



Servierkorb „BURGER & FRIES“

serving basket  
cesta para servir  
corbeille de service



Servierkorb aus Metall mit 2 Halter für Dipschälchen  
metal serving basket with 2 holders for dip bowls  
cesta de metal para servir con 2 soportes para cuencos para dip  
corbeille de service en métal avec 2 supports pour ramequins

	cm	↑ cm
40604	39,5 x 20	11

passende Schälchen / fitting bowls / cuencos adecuados / bols apropiés



	Ø cm	↑ cm	ltr.
83781	7	3,7	0,05

Servierbeispiel - Lieferung ohne Schälchen  
delivery without bowls

# Körbe



## Korb „URBAN“

basket  
cesta  
corbeille



	∅ cm	↑ cm	Farbe / Colour
30410	17	7,0	■
30411	20	8,5	■



## Korb „URBAN“

basket  
cesta  
corbeille



	cm	↑ cm	Farbe / Colour
30412	21 x 10	7	■
30413	30 x 14	12	■



## GN Korb „URBAN“

GN basket  
GN cesta  
GN corbeille



	cm	↑ cm	GN	Farbe / Colour
30414	53,0 x 32,5	7,5	1/1	■
30415	32,5 x 26,5	7,5	1/2	■
30416	53,0 x 16,2	7,5	2/4	■

### GN Abdeckhaube / GN cover / GN cubierta / GN cloche

	cm	↑ cm	GN	
11044	53 x 16,2	10,5	2/4	
11042	53 x 32,5	9,5	1/1	ohne Abbildung
11022	33 x 28,0	17,0	1/2	ohne Abbildung
11027	54 x 33,0	20,0	1/1	



**Brot- und Obstkorb „WIRE“**

wire basket  
cesta para pan o fruta  
corbeille pour pain ou fruits



	Ø cm	↑ cm	Farbe / Colour
30205	31	14	metal chrome



	Ø cm	↑ cm	Farbe / Colour
30206	31	14	metal black

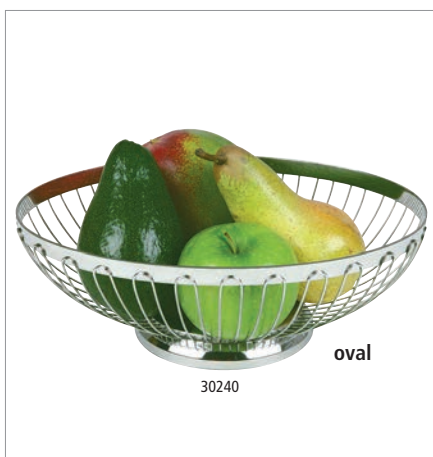

**Brot- und Obstkorb**

basket for bread or fruits  
cesta para pan o fruta  
corbeille à pain ou à fruits



hochglanzpoliert  
mirror polished finish  
acabado pulido brillante  
brillant

	Ø cm	↑ cm
30200	17,5	7,0
30220	20,5	8,5
30230	25,5	9,5



**Brot- und Obstkorb**

basket for bread or fruits  
cesta para pan o fruta  
corbeille à pain ou à fruits



hochglanzpoliert  
mirror polished finish  
acabado pulido brillante  
brillant

	cm	↑ cm
30210	20 x 15	7,0
30240	24 x 19	8,5
30250	28 x 21	9,5



**Obstkorb**

basket for fruits  
cesta para fruta  
corbeille à fruits



hochglanzpoliert  
mirror polished finish  
acabado pulido brillante  
brillant

	Ø cm	↑ cm
30270	21,5	20,5

## Körbe



### Brot- und Obstkorb

basket for bread or fruits  
cesta para pan o fruta  
corbeille à pain ou fruits



	Ø cm	↑ cm		
30207	21	16,5	black	copper-look handle
30208	30	19,0	black	copper-look handle



### Schale

bowl  
cuenco  
bol



gehämmerte Oberfläche  
hammered (surface)  
superficie martillada  
surface martelée

	cm	↑ cm	litr.
40189	20 x 13,5	5,5	0,30
40190	24 x 16,5	7,0	0,45



### Brot- und Obstschale

bowl for bread or fruits  
bol para pan o frutas  
bol à pain ou à fruits



hochglanzpoliert, Hammerschlag Optik  
mirror polished finish, hammered look  
acabado pulido efecto espejo, aspecto repujado  
brillant, aspect martelé

	Ø cm	↑ cm
30276	16	5,0
30277	20	5,5



### Edelstahl-Schale

bowl  
bandeja ovalada inox  
corbeille ovale inox



ingerollter Rand / rolled edge / borde redondeado / bord roulé

	cm	↑ cm
40110	26,5 x 18,5	4,0
40115	31,0 x 21,0	4,5



### Brot- und Obstkorb

basket for bread or fruits  
cesta para pan o fruta  
corbeille à pain ou fruits



	Ø cm	↑ cm
30310	18	7,5
30320	23	9,0





**Buffetständer / -korb „ASIA PLUS“**

buffet stand / basket  
soporte para buffet / cesta  
présentoir buffet / corbeille



	Ø cm	↑ cm	Farbe / Colour
15507	15	10,5	—
15510	15	10,5	—



**Buffetständer / -korb „ASIA PLUS“**

buffet stand / basket  
soporte para buffet / cesta  
présentoir buffet / corbeille



	Ø cm	↑ cm	Farbe / Colour
15508	21	10,5	—
15511	21	10,5	—



**Buffetständer / -korb „ASIA PLUS“**

buffet stand / basket  
soporte para buffet / cesta  
présentoir buffet / corbeille



	Ø cm	↑ cm	Farbe / Colour
15509	21	20	—
15512	21	20	—

# Körbe



## Korb / Ständer „BASKET“

basket / riser  
cesta / soporte  
corbeille / support



	Ø cm	↑ cm	Farbe / Colour
15321	21 / 15	11	
15325	21 / 15	11	
15323	21 / 15	11	



## Korb / Ständer „BASKET“

basket / riser  
cesta / soporte  
corbeille / support



	Ø cm	↑ cm	Farbe / Colour
15320	10,5 / 8	8	
15324	10,5 / 8	8	
15322	10,5 / 8	8	



## Korb / Ständer „BASKET“

basket / riser  
cesta / soporte  
corbeille / support



**Chrom poliert**  
polished chrome  
color plata brillante  
chrome poli

	Ø cm	↑ cm	Farbe / Colour
15331	15	10,5	
15332	21	20,0	



## Korb / Ständer „BASKET“

basket / riser  
cesta / soporte  
corbeille / support



**Gold, gebürstet**  
brushed gold  
dorado cepillado  
doré brossé

	Ø cm	↑ cm	Farbe / Colour
15334	15	10,5	
15335	21	20,0	



Korb / Ständer „BASKET“

basket / riser  
cesta / soport  
corbeille / support



	Ø cm	↑ cm	Farbe / Colour
15326	21 / 15	21	■



Box „BROTSTATION“

box  
caja de pan para buffet  
boîte à pain pour le buffet



Buchen-Holz

beech  
haya  
hêtre

	cm	↑ cm
00959	34 x 26	12,5
00954	34 x 26	20,0

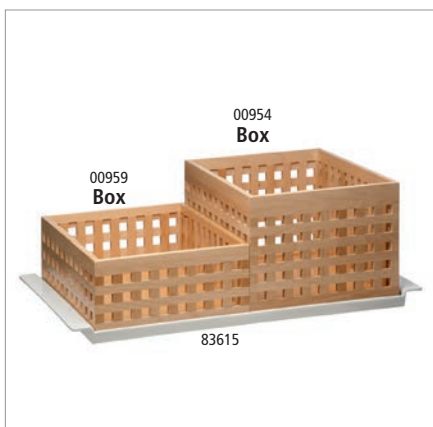

Tablett „BROTSTATION“

tray  
bandeja  
plateau



Antirutsch-Füßchen

non-slip feet  
pies antideslizantes  
pieds antidérapants

	cm	↑ cm
83615	59,5 x 35,5	3,5



Brot Schneidebrett „BROTSTATION“

cutting board  
tabla de corte  
planche à découper



Buchen-Holz

beech  
haya  
hêtre

	cm	↑ cm
00953	52 x 34	2

	cm	↑ cm
83615	59,5 x 35,5	3,5





# Chafing Dish, GN Container & Transport

**Chafing Dish**  
**Suppentöpfe**  
**Heizelemente**  
**GN-Behälter**  
**Servier-/Transportwagen**

chafing dish  
marmitas de sopa  
resistencias  
GN cubetas  
carro de servicio

chafing dish  
soup warmers  
heating units  
GN-container  
serving trolley

chafing dish  
marmites à soup  
résistances  
GN bacs  
chariot de service

# EASY INDUCTION



die Deckelbremse sorgt für langsames Schließen

the revolving cover closes gently, thanks to a special built-in axle

sistema de freno para un cierre suave de la tapa

système avec frein pour une fermeture en douceur du couvercle



Druckhebel zum leichten Entnehmen des GN-Behälters

stick for easy removing of the GN-container

dispositivo para levantar y quitar con facilidad la cubeta GN

dispositif pour lever et retirer facilement le bac GN



abnehmbarer Glas-Deckel mit Wasserrücklaufsystem

removable glass lid, with water-runback-system

tapa transparente desmontable con sistema de retorno de la condensación

couvercle transparent amovible avec système de retour de la condensation



Fixierschraube verhindert das Rutschen

fixing screw for skid resistance

Pie trasero anti-deslizante, altura regulable

Pied supplémentaire anti-dérapant réglable en hauteur



## GN 1/1 Chafing Dish „EASY INDUCTION“



1 Gestell + 1 Wasserbecken mit Sandwichboden + 1 Deckel mit hydraulischem Gelenk + 1 GN 1/1 Behälter 65 mm tief, hitzebeständige Griffe, hochwertige Verarbeitung, ausschließlich für Induktionskochfelder

1 frame + 1 waterpan with sandwich base + 1 hydraulic cover + 1 GN 1/1 container 65 mm, heat-resistant handles, high quality, only for induction plates

1 marco + 1 baño maría con base sandwich + 1 marco con tapa hidráulica + 1 cubeta GN 1/1 pan 65 mm profundo, asas resistentes al calor, buenos acabados, solamente para inducción

1 pied support + 1 bac bain-marie avec fond sandwich + 1 cadre avec couvercle hydraulique + 1 bac GN 1/1 - 65mm, poignées résistantes à la chaleur, belle qualité, uniquement pour induction

	cm	↑ cm	GN	ltr.
12322	60 x 42	30	1/1	9



## GN 2/3 Chafing Dish „EASY INDUCTION“



1 Gestell + 1 Wasserbecken mit Sandwichboden + 1 Wasserbeckenrahmen + 1 Deckel mit hydraulischem Gelenk + 1 GN 2/3 Behälter 65 mm tief, hitzebeständige Griffe, hochwertige Verarbeitung, ausschließlich für Induktionskochfelder

1 frame + 1 waterpan with sandwich base + 1 frame for waterpan + 1 hydraulic cover + 1 GN 2/3 container 65 mm, heat-resistant handles, high quality, only for induction plates

1 marco + 1 baño maría con base sandwich + 1 marco con tapa hidráulica + 1 cubeta GN 2/3 pan 65 mm profundo, asas resistentes al calor, buenos acabados, solamente para inducción

1 pied support + 1 bac bain-marie avec fond sandwich + 1 cadre avec couvercle hydraulique + 1 bac GN 2/3 - 65mm, poignées résistantes à la chaleur, belle qualité, uniquement pour induction

	cm	↑ cm	GN	ltr.
12323	42 x 41	30	2/3	5,5





Lieferung ohne Induktionskochplatte  
delivery without induction plate  
se entrega sin placa de inducción  
livré sans plaque à induction

### Chafing Dish „EASY INDUCTION“



1 Gestell + 1 Wasserbecken mit Sandwichboden + 1 Deckel mit hydraulischem Gelenk + 1 runder Speisenbehälter, hitzebeständige Griffe, hochwertige Verarbeitung, ausschließlich für Induktionskochfelder geeignet

1 frame + 1 waterpan with sandwich base + 1 hydraulic cover + 1 round foodpan, heat-resistant handles, high quality, good for induction plates

1 soporte + 1 baño maría con base sandwich + 1 tapa hidráulica + 1 cubeta redonda, asas resistente al calor, buen acabado, apto para inducción

1 pied support + 1 bac bain-marie avec fond sandwich + 1 cadre avec couvercle hydraulique + 1 bac rond, poignées résistantes à la chaleur, belle qualité, uniquement pour induction

	cm	↑ cm	ltr.
12324	46 x 50	30	6



Lieferung ohne Induktionskochplatte  
delivery without induction plate  
se entrega sin placa de inducción  
livré sans plaque à induction

### Chafing Dish „EASY INDUCTION“



1 Gestell + 1 Wasserbecken mit Sandwichboden + 1 Deckel mit hydraulischem Gelenk + 1 runder Speisenbehälter, hitzebeständige Griffe, hochwertige Verarbeitung, ausschließlich für Induktionskochfelder geeignet

1 frame + 1 waterpan with sandwich base + 1 hydraulic cover + 1 round foodpan, heat-resistant handles, high quality, good for induction plates

1 soporte + 1 baño maría con base sandwich + 1 tapa hidráulica + 1 cubeta redonda, asas resistente al calor, buen acabado, apto para inducción

1 pied support + 1 bac bain-marie avec fond sandwich + 1 cadre avec couvercle hydraulique + 1 bac rond, poignées résistantes à la chaleur, belle qualité, uniquement pour induction

	cm	↑ cm	ltr.
12325	48 x 42	39	11



### Induktionskochplatte für Chafing Dish

induction plate for chafing dish  
placa de inducción para chafing dish  
plaque à induction pour chafing dish

mit Regler  
with power control  
con control de potencia  
avec régulateur

	Ø cm	
12295	24	900 W



82210  
4,3 ltr.

82215  
2 x 2 ltr.

Porzellan-Einsatz  
porcelain insert  
bandeja de porcelana  
bac supérieur en porcelaine



	Ø cm	↑ cm	ltr.	fits to
82210	39	6	4,3	12324
82215	39	6	4,0	12324

# PREMIUM



**langlebige Deckelbremse**  
Abnehmbarer Deckel, dieser lässt sich spielend leicht öffnen und schliessen, der Lauf des Deckels wird professionell gedämpft.



**Kondenswasser - Rücklaufsystem**  
Kondenswasser wird in das Wasserbecken zurückgeführt.



**Sandwichboden / Kapselboden**  
Induktionsfähiger Boden, direkt auf dem Induktionskochfeld einsetzbar. Perfekte Wärmeverteilung und Steuerung.



**Fixierschraube / Rutschsicherung**  
Höhenverstellbares Gelenk, fixiert das Gerät in dem Gestell und auf dem Tisch.



**Induktionskochplatte Nr. 12295**  
Induktionskochplatte wird einfach in das Gestell gelegt.



**stapelbar**  
Chafing Dish Rahmen sind übereinander stapelbar. Platzsparend und rutschfest stapeln und transportieren.



## Induktionskochplatte für Chafing Dish

induction plate for chafing dish  
placa de inducción para chafing dish  
plaque à induction pour chafing dish

mit Regler  
with power control  
con control de potencia  
avec régulateur

	Ø cm	
12295	24	900 W





Lieferung ohne Induktionskochplatte  
delivery without induction plate  
se entrega sin placa de inducción  
livré sans plaque à induction

GN 1/1 Chafing Dish „PREMIUM“



1 Gestell + 1 Wasserbecken mit Sandwichboden + 1 Wasserbeckenrahmen + 1 Deckel mit hydraulischem Gelenk + 1 GN 1/1 Behälter 65 mm tief, hitzebeständige Griffe, hochwertige Verarbeitung, ausschließlich für Induktionskochfelder

1 frame + 1 waterpan with sandwich base + 1 frame for waterpan + 1 hydraulic cover + 1 GN 1/1 container 65 mm, heat resistant handles, high quality, only for induction plates

1 soporte + 1 cubeta baño maría con base sandwich + 1 marco para cubeta baño maría + 1 tapa hidráulica + 1 cubeta GN 1/1 de 65 mm, asas resistentes al calor, acabado de alta calidad, solamente para inducción

1 pied support + 1 bac bain-marie avec fond sandwich + 1 cadre pour bac bain-marie + 1 couvercle hydraulique + 1 bac GN 1/1 de 65 mm, poignées résistantes à la chaleur, finition de qualité, uniquement pour induction

	cm	↑ cm	ltr.	
12370	66 x 48	33	9	mit Edelstahldeckel with stainless steel cover
12352	66 x 48	33	9	mit Glasdeckel with glass cover



Lieferung ohne Induktionskochplatte  
delivery without induction plate  
se entrega sin placa de inducción  
livré sans plaque à induction

Chafing Dish rund „PREMIUM“



1 Gestell + 1 Wasserbecken mit Sandwichboden + 1 Wasserbeckenrahmen + 1 Deckel mit hydraulischem Gelenk + 1 runder Speisenbehälter, hitzebeständiger Griff, hochwertige Verarbeitung, für Induktionskochfelder geeignet

1 frame + 1 waterpan with sandwich base + 1 frame for waterpan + 1 hydraulic cover + 1 round foodpan, heat resistant handle, high quality, suitable for induction plates

1 soporte + 1 cubeta baño maría con base sandwich + 1 marco para cubeta baño maría + 1 tapa hidráulica + 1 cubeta redonda, asa resistente al calor, acabado de alta calidad, apto para inducción

1 pied support + 1 bac bain-marie avec fond sandwich + 1 cadre pour bac bain-marie + 1 couvercle hydraulique + 1 bac rond, poignée résistante à la chaleur, finition de qualité, apte pour induction

	cm	↑ cm	ltr.	
12371	44 x 54	33	6	mit Edelstahldeckel with stainless cover
12353	44 x 54	33	6	mit Glasdeckel with glass cover

Speiseneinsatz / foodpan / cubeta / bac supérieur

12366



Lieferung ohne Induktionskochplatte  
delivery without induction plate  
se entrega sin placa de inducción  
livré sans plaque à induction

Chafing Dish rund „PREMIUM“



1 Gestell + 1 Wasserbecken mit Sandwichboden + 1 Wasserbeckenrahmen + 1 Deckel mit hydraulischem Gelenk + 1 runder Speisenbehälter, hitzebeständige Griffe, hochwertige Verarbeitung, für Induktionskochfelder geeignet

1 frame + 1 waterpan with sandwich base + 1 frame for waterpan + 1 hydraulic cover + 1 round foodpan, heat resistant handles, high quality, suitable for induction plates

1 soporte + 1 cubeta baño maría con base sandwich + 1 marco para cubeta baño maría + 1 tapa hidráulica + 1 cubeta redonda, asas resistentes al calor, acabado de alta calidad, apto para inducción

1 pied support + 1 bac bain-marie avec fond sandwich + 1 cadre pour bac bain-marie + 1 couvercle hydraulique + 1 bac rond, poignées résistantes à la chaleur, finition de qualité, apte pour induction

	cm	↑ cm	ltr.	
12372	44 x 48	39	10	mit Edelstahldeckel with stainless cover
12354	44 x 48	39	10	mit Glasdeckel with glass cover

Speisenbehälter / foodpan / cubeta superior / bac supérieur

12397

# GLOBE



die Deckelbremse sorgt für langsames Schließen

the revolving cover closes gently, thanks to a special built-in axle

resistencia los frenos del sistema garantizan un cierre suave de la tapa

système avec frein pour une fermeture en douceur du couvercle



abnehmbarer Deckel mit Wasserrücklaufsystem

lid can be taken off, with water runback system

tapa fácil de desmontar, y canal incorporado para recuperar el agua condensada

couvercle facile à démonter, rainure pour récupérer les gouttes de condensation



Kondenswasser wird in das Wasserbecken zurückgeführt

condensed water is led back into the waterpan

el agua de condensación vuelve a la cubeta de agua

l'eau de condensation retourne dans le bac d'eau

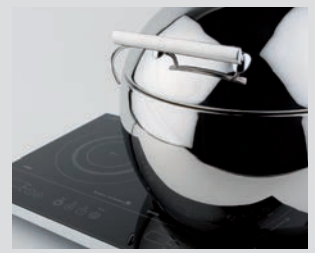

für alle Herdarten geeignet, auch für Induktionskochplatten

suitable for all kinds of ovens, even induction cookers

apto para todas las fuentes de calor, incluso inducción

apte pour toutes les sources de chaleur, y compris induction



## GN 1/1 Chafing Dish „GLOBE“



hochglanzpoliert, mit abnehmbarem hydraulischen Edelstahl-Deckel, Sandwichboden sorgt für optimale Wärmeleitung, für Induktionsplatten geeignet, Set: Gestell + Wasserbecken + Speisenbehälter GN 1/1 65 mm tief, 9 Liter + Löffelablage + 2 Brennpastenbehälter + Metallrahmen für Induktionskochplatte

mirror polished finish, removable stainless steel hydraulic cover, sandwich base for optimum heat distribution, suitable for induction plates

set: frame + waterpan + GN 1/1 container 65 mm, 9l + cutlery compartment ladles + 2 burner holder + frame for induction plate

pulido brillante, tapa hidráulica de acero inoxidable extraíble, fondo difusor sandwich apto para inducción, incluye: soporte + cubeta baño maría + cubeta GN 1/1 de 65 mm, 9l + soporte para cuchara (sin cuchara) + 2 quemadores + marco para la placa de inducción

poli brillant, couvercle inox hydraulique amovible, fond diffuseur sandwich apte pour induction, comprend: pied support + bac bain-marie + bac GN 1/1 de 65 mm, 9l + porte-louche (louche non incluse) + 2 brûleurs + cadre inox pour la plaque à induction

	cm	↑ cm	ltr.	
12394	66,5 x 44	34	9	mit Edelstahldeckel with stainless cover
12404	66,5 x 44	34	9	mit Glasdeckel with glass cover

Deckel mit Glasfenster / cover with glass insert / tapa con cristal / couvercle inox et verre

12391

Deckel Edelstahl / cover stainless steel / tapa de acero inoxidable / couvercle tout inox

12386

Induktionskochplatte für Chafing Dish / induction plate for chafing dish / placa de inducción para chafing dish / plaque à induction pour chafing dish

12295

Metallrahmen für Induktionskochplatte / frame for induction plate / estructura o marco para placa de inducción / cadre support inox pour plaque induction

12296



**Suppen-Kugel inkl. Gestell „GLOBE“**

soup bowl with stand  
cubeta sopa con soporte  
récipient à soupe avec pied



hochglanzpoliert, inkl. Speisenbehälter, 1 Brennpastenbehälter, mit einhängbarer Löffelablage, Sandwichboden sorgt für optimale Wärmeverteilung, für Induktionsplatten geeignet, einfaches Anbringen und Entfernen des Deckels, hitzeisolierende Griffe, 1 Metallrahmen für Induktionskochplatten

mirror polished finish, incl. foodpan and 1 burner holder, with fitting compartment for ladles, sandwich bottom for optimum heat distribution, gentle opening of the lid, heat-resistant handles, frame for induction plate

acabado pulido brillante, cubeta sopa inox, 1 quemador, platillo a colgar para el cucharón, fondo difusor sandwich, apto para inducción, tapa con apertura controlada, asas frías, marco para placa de inducción

poli brillant, récipient à soupe inox, 1 brûleur, repose-couvert à accrocher, fond diffuseur sandwich, apte pour induction, couvercle à ouverture contrôlée, anses froides, cadre support inox pour plaque à induction

	Ø cm	↑ cm	ltr.
12398	48	45	10

**Induktionskochplatte für Chafing Dish / induction plate for chafing dish / placa de inducción para chafing dish / plaque à induction pour chafing dish**

12295

**Metallrahmen für Induktionskochplatten / frame for induction plate / marco para placa de inducción / cadre support inox pour plaque induction**

12291



**Suppen-Kugel „GLOBE“**

soup bowl  
cubeta sopa  
récipient à soupe



hochglanzpoliert, inkl. Speisenbehälter, mit einhängbarer Löffelablage, Sandwichboden sorgt für optimale Wärmeverteilung, für Induktionsplatten geeignet, einfaches Anbringen und Entfernen des Deckels, hitzeisolierende Griffe (Lieferung ohne Gestell, Löffel)

mirror polished finish, incl. foodpan, with fitting compartment for ladles, sandwich bottom for optimum heat distribution, gentle opening of the lid, heat-resistant handles (delivery without rack, ladle)

acabado pulido brillante, cubeta sopa inox, platillo a colgar para el cucharón, fondo difusor sandwich, apto para inducción, tapa con apertura controlada, asas frías (cucharón no incluido)

poli brillant, récipient à soupe inox, repose-couvert à accrocher, fond diffuseur sandwich, apte pour induction, couvercle à ouverture contrôlée, anses froides (cadre, louche non incluse)

	Ø cm	↑ cm	ltr.
12399	48	32	10

**Gestell inkl. Brenner / frame incl. burner / soporte incluyendo quemador / support, brûleur inclus**

12396

**Speisenbehälter / foodpan / cubeta superior / bac supérieur**

12397



Chafing Dish „GLOBE“



hochglanzpoliert, mit abnehmbarem hydraulischen Edelstahl-Deckel, Sandwichboden sorgt für optimale Wärmeleitung, für Induktionsplatten geeignet

Set: Gestell + Wasserbecken + Speisenbehälter rund + Löffelablage + Brennpastenbehälter + Metallrahmen für Induktionskochplatte

mirror polished finish, removable hydraulic cover, sandwich base, optimum heat distribution set: frame + waterpan + foodpan round + cutlery compartment ladles + burner holder + frame for induction plate

pulido brillante, con tapa hidráulica extraíble, fondo difusor sandwich apto para inducción. Incluye: 1 pie, 1 cubeta baño maría, 1 cubeta redonda, 1 soporte para cuchara (sin cuchara), 1 quemador, marco inox para la placa de inducción

brillant, couvercle hydraulique amovible, fond diffuseur sandwich apte pour induction. Comprend: pied, cuve bain-marie, bac inox rond, porte-louche (louche non incluse), 1 brûleur, cadre inox pour la plaque à induction

	Ø cm	↑ cm	ltr.	
12393	38,5	34	6	mit Edelstahldeckel with stainless cover
12403	38,5	34	6	mit Glasdeckel with glass cover

Deckel mit Glasfenster / cover with glass insert / tapa con cristal / couvercle inox et verre

12390

Deckel Edelstahl / cover stainless steel / tapa de acero inoxidable / couvercle tout inox

12385

Induktionskochplatte für Chafing Dish / induction plate for chafing dish / placa de inducción para chafing dish / plaque à induction pour chafing dish

12295

Metallrahmen für Induktionskochplatten / frame for induction plate / marco para placa de inducción / cadre support inox pour plaque induction

12291

Speiseneinsatz / foodpan / cubeta / bac supérieur

12366



Porzellan-Einsatz

porcelain insert

bandeja de porcelana

bac supérieur en porcelaine



	Ø cm	↑ cm	ltr.	fits to
82210	39	6	4,3	12393, 12403
82215	39	6	4,0	12393, 12403



GN 2/3 Chafing Dish „GLOBE“



hochglanzpoliert, mit abnehmbarem hydraulischen Edelstahl-Deckel, Sandwichboden sorgt für optimale Wärmeleitung, für Induktionsplatten geeignet, Set: Gestell + Wasserbecken + 1 GN 2/3 Behälter 65 mm tief + Löffelablage + 1 Brennpastenbehälter + 1 Metallrahmen für Induktionskochplatte

mirror polished finish, removable hydraulic cover, sandwich base, optimum heat distribution, set: frame + waterpan + foodpan GN 2/3, 65 mm, 5,5 l + compartment for ladles + burner holder + frame for induction plate

pulido brillante, con tapa hidráulica extraíble, fondo difusor sandwich apto para inducción. Incluye: 1 pie, 1 cubeta baño maría, 1 cubeta GN 2/3 65 mm - 5,5 l, 1 soporte para cuchara (sin cuchara), 1 quemador, marco inox para la placa de inducción

poli brillant, couvercle hydraulique amovible, fond diffuseur sandwich apte pour induction. Comprend: pied, cuve bain-marie, bac inox GN 2/3-65 mm - 5,5 L, porte-louche (louche non incluse), brûleur, cadre inox pour la plaque à induction

	cm	↑ cm	ltr.	
12483	44 x 41	34	5,5	mit Edelstahl-Deckel with stainless steel cover
12484	44 x 41	34	5,5	mit Glasdeckel with glass cover



Rolltop-Chafing Dish „MAESTRO“



Speisenbehälter GN1/1 65 mm tief (passend auch für 100 mm) + Rolltop-Deckel 90° + Wasserbecken inkl. Vorrichtung für Heizplatte + 2 Brennpastenbehälter

foodpan GN1/1 65 mm (also for 100 mm) + rolltop cover 90° + waterpan with screws for heating unit + 2 burner holders

cubeta GN 1/1 - 65 mm (hay espacio para una cubeta 100 mm) + campana rolltop abatible a 90° + 2 quemadores

bac GN 1/1 - 65 mm (accepte aussi bac ht. 100 mm) + couvercle rolltop ouverture 90° + 2 brûleurs

	cm	↑ cm	ltr.
12300	67 x 35	45	9



Rolltop-Chafing Dish „ELITE“



poliert, Rolltop-Deckel klappbar auf 90° und 180°, Speisenbehälter GN 1/1 65 mm tief + Wasserbecken + 2 Brennpastenbehälter, wechseln des GN-Behälters ohne abnehmen des Deckels (kein Kondenswasser-Rücklaufsystem)

polished, rolltop cover adjustable at 90° and 180°, foodpan GN 1/1 65 mm deep + waterpan + 2 burner holders, change of the GN container without removing the lid (condensed water can not be led back into the waterpan)

pulido brillante, tapa rolltop a 90° o 180°, cubeta GN 1/1 + 2 quemadores, cuba baño maría, se puede cambiar la cubeta GN sin retirar la tapa, importante: el agua condensada no revierte en los alimentos

poli brillant, couvercle rolltop ouverture de 90 a 180°, bac GN 1/1, bain-marie, 2 brûleurs, le bac GN peut être retiré et remplacé sans démonter le couvercle, important: la condensation ne retombe pas sur les aliments

	cm	↑ cm	ltr.
12350	67 x 47	45	9

Wasserbecken inkl. Vorrichtung für Heizelement / waterpan / baño maría / bain-marie

12249



inkl. Vorrichtung für Heizelement  
incl. screws for heating unit



Rolltop-Chafing Dish „CATERER“



Speisenbehälter GN 1/1 65 mm tief + Rolltop-Deckel 90° + Wasserbecken inkl. Vorrichtung für Heizplatte + 2 Brennpastenbehälter (Lieferung ohne Heizplatte), massiver Ständer

foodpan GN 1/1 65 mm deep + rolltop cover 90° + waterpan with screws for heatingunit + 2 burner holders (without heating unit), stable frame

1 cubeta GN 1/1 - 65 mm + campana rolltop abatible a 90° + 2 quemadores + cuba baño maría con fijaciones para resistencia amovible (se sirve sin la resistencia)

1 bac GN 1/1 - 65 mm + couvercle rolltop ouverte 90° + 2 brûleurs + 1 bac bain-marie avec 4 vis pour fixation résistance de chauffe amovible (non include)

	cm	↑ cm	ltr.
12245	67 x 35	45	9

Wasserbecken inkl. Vorrichtung für Heizelement / waterpan / baño maría / bain-marie

12249



Chafing Dish „CATERER PRO“



Deckel hochglanzpoliert, Deckelgriffe hitzebeständig + 2 Brennpastenbehälter + Wasserbecken, inkl. Vorrichtung für Heizplatte + Gestell mit Deckelhalterung (ohne GN Speisenbehälter)

cover mirror polished finish, cover knob heat-resistant + 2 burner holders + waterpan with screws for heating unit + frame with coverholder (without GN foodpan)

tapa pulido brillante, asas frías + 2 quemadores + cuba inferior con tornillos para resistencia removable (no incluida) + tapa y estructura con sujeción de la tapa (se sirve sin la cubeta GN)

couvercle poli brillant, anses froides + 2 brûleurs + bac bain-marie avec fixations pour résistance amovible (non include)

	cm	↑ cm
12233	64 x 35	34

Ersatzdeckel / replacement cover / tapa de recambio / couvercle de rechange

12236

Wasserbecken inkl. Vorrichtung für Heizelement / waterpan / baño maría / bain-marie

12249



Chafing Dish „CATERER“



Speisenbehälter GN 1/1 65 mm tief + 2 Brennpastenbehälter + Wasserbecken inkl. Vorrichtung für Heizelement + Deckel + Gestell mit Deckelhalterung (Lieferung ohne Heizelement)

foodpan GN 1/1 65 mm deep + 2 burner holders + 1 waterpan with screws for heating unit + cover + frame with coverholder (without heating unit)

1 cubeta GN 1/1 - 65 mm + 2 quemadores + cuba baño maría con fijaciones para resistencia amovible + estructura con bloqueo tapa (se sirve sin la resistencia)

1 bac GN 1/1 - 65 mm + 2 brûleurs + 1 bac bain-marie avec 4 vis pour fixation d'une résistance de chauffe amovible (non include) + couvercle + chassis avec blocage couvercle

	cm	↑ cm	ltr.
12240	67 x 35	35	9

Ersatzdeckel / replacement cover / tapa de recambio / couvercle de rechange

12260

Wasserbecken inkl. Vorrichtung für Heizelement / waterpan / baño maría / bain-marie

12249



hot price

Chafing Dish „CHEF“



Speisenbehälter GN 1/1 65 mm tief + 2 Brennpastenbehälter + Wasserbecken + Deckel + Gestell mit Deckelhalterung + langer Hohlgriff

foodpan GN 1/1 65 mm + 2 burner holders + waterpan + cove + frame with coverholder

1 cubeta GN 1/1 65 mm + 2 quemadores + cubeta para el agua + tapa y chasis con bloqueo para la tapa

1 bac GN 1/1 - 65 mm + 2 brûleurs + 1 bac bain-marie + couvercle + chassis avec blocage couvercle + poignée tube creux

	cm	↑ cm	ltr.
11675	61 x 31	30	9



Suppentopf „HOT POT“



hot pot / soup pot  
olla para buffet  
marmite de buffet

Speisenbehälter + Wasserbecken + 1 Brennpastenbehälter + Deckel + Gestell

foodpan + waterpan + 1 burner holder + cover + frame

cubeta + baño maría + 1 quemador + tapa + soporte

réipient + bain-marie + 1 brûleur + couvercle + support

	Ø cm	↑ cm	ltr.
11678	33	35	13,5



Speisenwärmer „PROFI“



plate warmer  
calienta platos  
chauffe-plat

Rahmen aus Edelstahl mit Aluminium-Wärmeplatte

stainless steel frame, thick aluminium plate

soporte inox con placa de aluminio

support inox avec plaque aluminium

	cm	↑ cm	
35050	33 x 18	7	2 Teelichter / 2 tealights 2 velas / 2 bougies



hot price

Speisenwärmer



warmer  
calienta platos  
chauffe-plat

3-flammig / 3 lights / 3 velas / 3 bougies

	cm	↑ cm
35065	34 x 18	6



hot price

Speisenwärmer



warmer  
calienta platos  
chauffe-plat

2-flammig, matt poliert

2 lights, satin polished finish

2 velas, acero inoxidable acabado mate

2 bougies, inox finition mate

	cm	↑ cm
35343	34 x 13	6



**Elektro-Rolltop-Chafing Dish „ELITE“**

electric rolltop chafing dish  
chafing dish eléctrico rolltop  
chafing dish électrique rolltop



poliert, Rolltop-Deckel klappbar auf 90° und 180°, Elektro-Wasserbecken mit Temperaturregelung + Speisenbehälter GN 1/1 100 mm tief, 220 - 240 V ~ 50 Hz; 760 - 900 W (kein Kondenswasser-Rücklaufsystem)

polished, rolltop cover adjustable at 90° and 180°, electric waterpan with adjustable heatcontrol + foodpan GN 1/1 100 mm deep, voltage 220 - 240 V ~ 50 Hz, power consumption 760 - 900 W (condensed water cannot be led back into the waterpan)

pulido brillante, tapa abatible apertura a 90° o 180°, baño maría c/ termostato + cubeta GN 1/1 - 100 mm, 220-240 V-50 Hz. Consumo 760-900 W (el agua condensada no gotea dentro de la cubeta)

poli brillant, couvercle rolltop ouverture à 90° ou 180°, bain-marie électrique avec thermostat + bac GN 1/1-100 mm, 220-240 V - 50 Hz; 760-900 W (Important: la condensation ne retombe pas sur les aliments)

	cm	↑ cm	ltr.
12360	67 x 47	45	14



**Elektro-Rolltop-Chafing Dish „ELITE“**

electric rolltop chafing dish  
chafing dish eléctrico rolltop  
chafing dish électrique rolltop



poliert, Rolltop-Deckel klappbar auf 90° und 180°, Elektro-Wasserbecken mit Temperaturregelung + Speisenbehälter, 220 - 240 V ~ 50 Hz; 420 - 500 W (kein Kondenswasser-Rücklaufsystem)

polished, rolltop cover adjustable at 90° and 180°, electric waterpan with adjustable heatcontrol + foodpan, voltage 220 - 240 V ~ 50 Hz, power consumption 420 - 500 W (condensed water cannot be led back into the waterpan)

pulido brillante, tapa abatible apertura a 90° o 180°, baño maría c/ termostato - 220-240 V-50 Hz. 420-500 W (el agua condensada no gotea dentro de la cubeta)

poli brillant, couvercle rolltop ouverture à 90° ou 180°, bain-marie électrique avec thermostat, 220-240 V - 50 Hz; 420-500 W (Important: la condensation ne retombe pas sur les aliments)

	Ø cm	↑ cm	ltr.
12356	45	45	6,8

Speisenbehälter / foodpan / cubeta superior / bac supérieur

12357



**Rolltop-Chafing Dish „ELITE“**



poliert, Rolltop-Deckel klappbar auf 90° und 180° + Speisenbehälter + Wasserbehälter inkl. Vorrichtung für Heizplatte + 1 Brennpastenbehälter, Hohlgriff kann nicht heiß werden, wechseln des Behälters ohne abnehmen des Deckels (kein Kondenswasser-Rücklaufsystem)

polished, rolltop cover adjustable at 90° and 180° + foodpan + 1 burner holder, waterpan with screws for heating unit (not included), change of the container without removing the lid (condensed water can not be led back into the waterpan)

pulido brillante, tapa rolltop a 90° o 180°, cubeta + 1 quemadores, cuba baño maría con fijaciones para resistencia (se sirve sin la resistencia), se puede cambiar la cubeta GN sin retirar la tapa, importante: el agua condensada no revierte en los alimentos

poli brillant, couvercle rolltop ouverture de 90° a 180°, bac, bain-marie avec 4 vis pour fixation résistance de chauffe amovible (non incluse), 2 brûleurs, le bac GN peut être retiré et remplacé sans démonter le couvercle, important: la condensation ne retombe pas sur les aliments

	Ø cm	↑ cm	ltr.
12355	45	45	5





**Elektro-Chafing Dish „INOXSTAR“**

electric chafing dish  
chafing dish eléctrico  
chafing dish électrique



poliert, Thermostat-Regelung, Speisenbehälter GN 1/1 100 mm tief, Deckelhalter, 900 W, 230 V  
polished, thermostat control, foodpan GN 1/1 100 mm deep, lid holder, 900 W, 230 V  
pulido brillante, termostato de control, cubeta GN 1/1-100 mm, bloqueo para la tapa, 900 W, 230 V  
poli brillant, thermostat, bac GN 1/1-100 mm, blocage du couvercle, 900 W, 230 V

	cm	↑ cm	ltr.
12222	62 x 35	29	13,5

Deckel / cover / tapa / couvercle

12235



**Elektro Chafing Dish**

electric chafing dish  
chafing dish eléctrico  
chafing dish électrique



Speisenbehälter GN 1/1 100 mm tief, Deckelhalter, Thermostat-Regelung 900 W, 230 V  
foodpan GN 1/1 100 mm deep, lid holder, thermostat control 900 W, 230 V  
cubeta GN 1/1-100 mm, sujeción de la tapa, termostato, 900W, 230 V  
bac GN 1/1-100 mm, blocage du couvercle, thermostat, 900W, 230 V

	cm	↑ cm	ltr.
12225	63 x 36	29	14

Deckel / cover / tapa / couvercle

12235



**Elektro-Chafing Dish „ECO“**

electric chafing dish  
chafing dish eléctrico  
chafing dish électrique



Deckel poliert, Elektro-Wasserbecken mit Temperaturregelung + Speisenbehälter GN 1/1 65 mm tief, 220 - 240 V ~ 50 Hz; 760 - 900 W  
cover polished, electric waterpan with adjustable heatcontrol + foodpan GN 1/1 65 mm deep, voltage 220 - 240 V ~ 50 Hz, power consumption 760 - 900 W  
tapa pulido brillante, baño maría c/ termostato + cubeta GN 1/1 - 65 mm - 220-240 V-50 Hz. / 760-900 W  
couvercle poli brillant, bain-marie électrique avec thermostat + bac GN 1/1-65 mm, 220-240 V - 50 Hz; 760-900 W

	cm	↑ cm	ltr.
12232	63 x 36	29	9



**Elektro-Chafing Dish „ECO“**

electric chafing dish  
chafing dish eléctrico  
chafing dish électrique



Glasdeckel (Rand poliert), Elektro-Wasserbecken mit Temperaturregelung + Speisenbehälter, 220 - 240 V ~ 50 Hz; 420 - 500 W  
cover polished, electric waterpan with adjustable heatcontrol + foodpan, voltage 220 - 240 V ~ 50 Hz, power consumption 420 - 500 W  
tapa vidrio borde pulido brillante, baño maría c/ termostato - 220-240 V-50 Hz. 420-500 W  
couvercle verre bord poli brillant, bain-marie électrique avec thermostat, 220-240 V - 50 Hz; 420-500 W

	Ø cm	↑ cm	ltr.
12221	36	25	6,8

hot price



**Elektrischer Suppentopf „ECONOMIC“**

electric soup warmer  
marmita de sopa eléctrica  
marmite à soupe électrique



Stahl schwarz lackiert, herausnehmbarer Einsatz aus Edelstahl, Temperaturregelung 30°C - 90°C, dreh- und klappbarer Edelstahl-Deckel, inkl. 8 magnetisch haftenden Beschriftungen, 400 W / 230 V

metal, black, removable soup pot, thermostat 30°C - 90°C, st. steel lid, incl. 8 magnetic signs, 400 W / 230 V

metal negro, recipiente sopa inox extraíble, termostato 30°C- 90°C, tapa inox, incluye 8 letreros magnéticos, 400 W / 230 V

acier, noir, récipient à soupe inox amovible, thermostat 30°C - 90°C, couvercle inox, 8 étiquettes magnétiques, 400 W / 230 V

	Ø cm	↑ cm	ltr.
11915	32	36	9

Speisenbehälter / foodpan / recipiente sopa / récipient à soupe

11916

Deckel / cover / tapa / couvercle

11917

ohne Wasserbad  
without water bath



**Elektrischer Suppentopf**

electric soup warmer  
marmita de sopa eléctrica  
marmite à soupe électrique



direkte Wärmeübertragung ohne Wasserbad, manuelle Temperaturregelung mit digitalem Anzeigenfenster, Temperatur einstellbar zwischen 60° C und 80° C, 1000 W / 230 V, herausnehmbarer Einsatz aus Edelstahl, Deckel mit hitzeisoliertem Griff und Löffelaussparung

direct heat transfer without bain marie, manual temperature control with digital display window, temperature adjustable between 60° C and 80° C, 1000 W / 230 V, removable stainless steel insert, lid with heat insulated handle and notched for spoon

traspaso térmico directo sin baño maría, control manual de la temperatura con ventana de visualización digital, temperatura ajustable entre 60° C y 80° C, 1000 W / 230 V, inserto de acero inoxidable extraíble, tapa con asas frías y con hueco para la cuchara

transfert direct de chaleur sans bain-marie, contrôle manuel de la température avec fenêtre d'affichage numérique, température réglable entre 60° C et 80° C, 1000 W / 230 V, insert en acier inoxydable amovible, couvercle avec poignée d'isolation thermique et avec espace pour la louche

	Ø cm	↑ cm	ltr.
11903	34,0	33,0	10

Speisenbehälter / foodpan / recipiente sopa / récipient à soupe

11906

Deckel / cover / tapa / couvercle

11907



**Elektrischer Suppentopf**

electric soup warmer  
marmita de sopa eléctrica  
marmite à soupe électrique



herausnehmbarer Einsatz aus Edelstahl, elektrisch, mit Wasserbad + Löffel + integrierter Tragering für den Innenbehälter, Deckel mit hitzeisolierendem Griff, Temperaturregelung 80°C (± 10°C), 450-550 W, 230 V

removable soup st. steel pan, bain marie electric, ladle, circular frame, thermostat control till 80°C (± 10°C), 450-550 W, 230 V

recipiente sopa inox extraíble, baño maria eléctrico + cucharón + aro inox, tapa con asas frías, termostato hasta 80°C precisión (± 10°C), 450-550 W, 230 V

réipient à soupe inox amovible, bain-marie électrique, louche, support circulaire inox, thermostat maxi 80°C (± 10°C), 450-550 W, 230 V

	Ø cm	↑ cm	ltr.
11901	38	36,5	10



**Elektrischer Suppentopf**

electric soup warmer  
marmita de sopa eléctrica  
marmite à soupe électrique



herausnehmbarer Einsatz aus Edelstahl, elektrisch, mit Wasserbad + Löffel + integrierter Tragering für den Innenbehälter, Deckel mit hitzeisolierendem Griff, Temperaturregelung 80°C (± 10°C), 400 - 450 W / 220 - 240 V

removable soup st. steel pan, bain marie electric, ladle, st. steel circular frame, thermostat control till 80°C (± 10°C), 400 - 450 W / 220 - 240 V

recipiente sopa inox extraíble, baño maria eléctrico + cucharón + aro inox, tapa con asas frías, termostato hasta 80°C precisión (±10°C) , 400 - 450 W / 220 - 240 V

réipient à soupe inox amovible, bain-marie électrique, louche, support circulaire inox, thermostat maxi 80°C (± 10°C), 400 - 450 W / 220 - 240 V

	Ø cm	↑ cm	ltr.
11910	40	37	10

**Edelstahlgefäß** / stainless steel pan / recipiente sopa inox / réipient à soupe inox

11911

**Edelstahl-Deckel** / stainless steel lid / tapa inox / couvercle inox

11912

**Elektrokabel** / electric cable / cable eléctrico / cable électrique

11913



**Elektro-Suppenstation**

soup warmer  
chafing dish doble para sopa  
chafing dish 2 soupieres



2 Suppentöpfe + 2 Suppenkellen + Deckelhalter, Thermostat (Überhitzungsschutz), 900 W, 230 V  
2 soup pots + 2 soup ladles + lid holder, thermostat control 900 W, 230 V  
incluye 2 ollas de sopa + 2 cucharones + bloqueo de la tapa, termostato 900 W, 230 V  
2 marmites + 2 louches + blocage du couvercle + thermostat, 900 W, 230 V

	cm	↑ cm	ltr.
12228	65 x 35,5	31	2 x 4



**Rolltophaube „SWISS“**

rolltop-cover  
campana rolltop  
cloche rolltop



hochglanzpoliert, klappbar auf 90°, nachrüstbar für alle handelsüblichen Chafer  
mirror polished finish, cover adjustable at 90°, usable for all commercial chafing dishes  
pulido brillante, tapa ajustable 90°, apto para todos los chafings profesionales  
poli brillant, ouverture réglable à 90°, apte pour tous les chafings professionnels

	cm	↑ cm
12310	55 x 34	19,5



**Bain-Marie Topf**

bain marie pot  
olla baño Maria  
marmite bain-marie



inkl. Deckel, mit Löffelaussparung  
included cover, notched for spoon  
incluye tapa con hueco para la cuchara  
includ le couvercle avec espace pour la louche

	Ø cm	↑ cm	ltr.
12244	20	18	4,5

Deckel / cover / tapa / couvercle

11244



**Bain-Marie Deckel**

cover for bain marie  
tapa del baño maría  
couvercle du bain-marie



	cm
12243	54 x 33,5



12 ltr.

### Kaffeedispenser „ROYAL“

coffee dispenser  
dispensador de café  
distributeur de café



hochglanzpoliert, für warme Getränke, stabil und standfest, inkl. 1 Brennpastenbehälter  
mirror polished finish, for warm drinks, solid and stable, incl. 1 burner holder  
acabado brillante para bebidas calientes, sólido y estable, incluye un calentador  
brillant, pour boissons chaudes, avec 1 brûleur, robuste et stable

	cm	↑ cm	ltr.
11667	28 x 28	65	12



10,5 ltr.

### Kaffeedispenser „HAPPY HOUR“

coffee dispenser  
dispensador de café  
distributeur de café



hochglanzpoliert, für warme Getränke, stabil und standfest, inkl. 1 Brennpastenbehälter  
mirror polished finish, for warm drinks, solid and stable, incl. 1 burner holder  
acabado pulido brillante para bebidas calientes, sólido y estable, incluye un calentador  
brillant, pour boissons chaudes, avec 1 brûleur, robuste et stable

	cm	↑ cm	ltr.
11672	31 x 33,5	54,5	10,5

Hahn / tap / grifo / robinet

11671

Elektro-Heizelement / heating unit / resistencia / résistance

	cm	↑ cm
12287	21 x 20	6



**Einbau-Induktionskochplatte für Chafing Dish**

built-in induction plate for chafing dish  
 placa de inducción para empotrar  
 plaque à induction à encastrer

**inkl. Kabel-Fernbedienung, energiesparend, Leistung in 5 Stufen regelbar, integrierte Lüftung, sehr leise im Betrieb**

incl. cable remote control, energy-saving, power adjustable in 5 steps, integrated ventilation, very quiet in operation

incl. mando a distancia con cable, ahorro energético, potencia regulable en 5 pasos, ventilación integrada, funcionamiento silencioso

y compris télécommande filaire, économe en énergie, puissance réglable en 5 étapes, ventilation intégrée, très silencieux en fonctionnement

	cm	↑ cm	
12285	35,5 x 35,5	6	2000 W



**Induktionskochplatte für Chafing Dish**

induction plate for chafing dish  
 placa de inducción para chafing dish  
 plaque à induction pour chafing dish

**mit Regler**

with power control

con control de potencia

avec régulateur

	Ø cm	
12295	24	900 W



**Metallrahmen für Induktionskochplatten**

frame for induction plate  
 marco para placa de inducción  
 cadre support inox pour plaque induction



12291	für runde Chafer / for round chafing dish
12296	für Chafer GN 1/1 / for GN 1/1 chafing dish



**Elektro-Heizelement**

heating unit  
 resistencia  
 résistance



**für Kaffeedispenser (Nr. 11672), 500 W, 220 V, einfach in das Gestell des Dispensers legen**  
 for coffee dispenser (no. 11672), 500 W, 220 V, insert into the frame of the dispenser  
 para dispensador de café (11672), 500 W, 220V, directamente en el pie del dispensador  
 pour distributeur à café (11672), 500 W, 220 V, directement dans le support

12287	500 W / 220 V
-------	---------------



**Mobile Chafing Dish Heizung**

heating element  
resistencia  
résistance



für alle marktgängigen Chafing Dishes

suitable for all current popular chafing dishes, with special spring

para todos los chafing dish más corrientes

pour la plupart des chafing dish les plus courants

	Ø cm	↑ cm	
12299	14	9 - 11	500 W / 220 V



**Heizplatte durch Spiralfeder an Wasserbad gedrückt**  
Heizplatte durch Spiralfeder an Wasserbad gedrückt



800 Watt

**Elektro-Heizelement**

heating unit  
resistencia  
résistance



für mehrheitlich geöffnete Chafer GN 1/1 mit einstellbarem Leistungsregler

for GN 1/1 chafer covers are open most of the time, with adjustable control

para GN 1/1 chafing dish abiertos, con termostato

pour chafing dish GN 1/1 dont le couvercle reste souvent ouvert, avec thermostat

12294	800 W / 230 V
-------	---------------



600 Watt

**Elektro-Heizelement**

heating unit  
resistencia  
résistance



für mehrheitlich geöffnetem Chafing Dish GN 1/1

for GN 1/1 chafer covers open most of the time

para chafing dish GN 1/1 con la tapa casi siempre abierta

pur chafing dish GN 1/1 dont le couvercle reste souvent ouvert

12292	600 W / 230 V
-------	---------------



360 Watt

**Elektro-Heizelement**

heating unit  
resistencia  
résistance



für mehrheitlich geschlossene Chafer GN 1/1

for GN 1/1 chafer covers are closed most of the time

para chafing dish GN 1/1 casi siempre cerrados

pour chafing dish GN 1/1 qui restent habituellement fermés

12290	360 W / 140 - 250 V
-------	---------------------



**Brennpastenbehälter**

burner holder  
quemador  
brûleur



mit Bajonettverschluss / bayonet lock / cierre de bayoneta / verrouillage par baionnette

	Ø cm	↑ cm
11683	9	6



**Flasche Brennflüssigkeit „HOT & SAFE“**

bottle fuel  
botella de combustible líquido  
bouteille de combustible liquide



	litr.
00208	1



**Wärme-Kies**

granite chips  
granulado térmico  
gravier thermique



für Chafing Dishes, feine Körnung, hohe Wärmespeicherung, kein Verkleben, ideal zum Warmhalten von Eiern

fine for chafing dishes and clean granite chippings, ideal for keeping eggs warm  
gravilla de granito fina limpia, ideal para mantener los huevos calientes  
gravier fin de granit, lavé, idéal pour maintenir les oeufs au chaud

	kg
81116	7



**Besteckablage**

cutlery rest  
reposa cuchara  
pose-cuillère



	cm	↑ cm
00650	27 x 11	3,5



**Besteckablage „SPOON“**

cutlery rest  
reposa cuchara  
pose-cuillère



	cm	↑ cm
83801	26 x 10,5	5



**Besteckablage „BOWL“**

cutlery rest  
reposa cuchara  
pose-cuillère



	cm	↑ cm	litr.
83803	22,5 x 11	6	0,5



**Besteckablage „SMALL WAVE“**

cutlery rest  
reposa cuchara  
pose-cuillère



	cm	↑ cm
83897	26 x 13	4,5



NEW



88200



88202



88205



88209



88204

GN-Behälter „INDU“

GN container  
GN cubeta  
GN bac



Behälter mit Keramik-Beschichtung, konstanter Antihaft-Effekt

container with ceramic coating, constant non-stick effect  
cubeta con revestimiento cerámico, efecto antiadherente constante  
bac avec revêtement céramique, effet anti-adhérent constant

	GN	cm	↑ cm	ltr.	Farbe / Colour
88200	1/1	53,0 x 32,5	7,5	7,5	White
88201	1/2	32,5 x 26,5	7,5	3,0	White
88202	2/3	35,4 x 32,5	7,5	4,5	White
88205	1/1	53,0 x 32,5	7,5	7,5	Black
88206	1/2	32,5 x 26,5	7,5	3,0	Black
88207	2/3	35,4 x 32,5	7,5	4,5	Black
88209	1/1	53,0 x 32,5	7,5	7,5	Blue
88210	1/2	32,5 x 26,5	7,5	3,0	Blue
88211	2/3	35,4 x 32,5	7,5	4,5	Blue

		Ø cm	↑ cm	ltr.	Farbe / Colour
88204	-	38,5	7,5	6,5	White
88208	-	38,5	7,5	6,5	Black
88212	-	38,5	7,5	6,5	Blue

Hinweis / Note / Remarque / Nota

Antihafbeschichtung ist nicht schnittfest. Keine scharfen oder spitzen Küchenhelfer verwenden. Ideal ist der Gebrauch von Küchenhelfer aus Holz oder Kunststoff.

Non-stick coating is not cut resistant. Do not use sharp or pointed kitchen utensils. Ideal is the use of kitchen helpers made of wood or plastic.

Le revêtement anti-adhésif n'est pas résistant aux coupures. N'utilisez pas d'ustensiles de cuisine tranchants ou pointus. L'idéal est d'utiliser des aides de cuisine en bois ou en plastique.

El recubrimiento antiadherente no es resistente al corte. No utilice utensilios de cocina afilados o puntiagudos. Lo ideal es el uso de utensilios de cocina de madera o plástico.



88200



88204



88201



## Chafing Dish, GN Container & Transport

### GN-Behälter Größen nach EN 631

Alle Behälter sind aus rostfreiem Chrom-Nickel-Edelstahl mit elektrolytisch polierter (seidenmatt) Oberfläche und somit perfekt geeignet für den professionellen Einsatz.

### GN-container according to EN 631

All pans are made of chrome/nickel stainless steel with a surface polished by electrolysis (satin-matt) and therefore highly suitable for professional operation.

### De conformidad con la norma europea EN 631.

Todos los contenedores están fabricados en acero inoxidable cromado/niquelado con su superficie (satinada) pulida por electrolisis lo que la hace altamente apropiado para el uso profesional.

### Bacs GN- Conforme à la norme EN 631

Tous les bacs sont fabriqués en inox/chrome/nickel, surface polie électrolythique (satiné). Approprié pour usage professionnel.

### Vorteile der rund geprägten U-Ecken:

- erhöhte Stabilität durch verstärktes Profil
- zielgerechtes und sauberes Ausgießen
- genaue Positionierung der GN-Behälter
- superleichtes Stapeln und Entstapeln
- kein Verklemmen der GN-Behälter
- hohe Stoßfestigkeit durch robuste Konstruktion
- ansprechendes Design und stilvoller Blickfang

### Advantages of the round-shaped U-Corners:

- increased stability due to the unique construction
- clean ladling and pouring
- exact positioning of the containers
- improved shock-resistance
- appealing design
- no seize of the containers

### Ventajas de las esquinas en U:

Perfil reforzado que confiere mayor rigidez y resistencia a la cubeta, diseño para verter fácil y limpiamente, fáciles de apilar y desapilar sin que se claven entre sí, construcción más robusta y resistente a los golpes mecánicos, diseño elegante.

### Avantages et fonctionnalité des angles en U:

Profil renforcé pour une meilleure consistance et rigidité du récipient, design qui facilite un versage propre et aisé, permet un empilage et déempilage faciles sans que les bacs restent coincés, meilleure résistance aux chocs mécaniques, seign élégant.

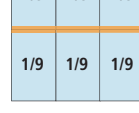
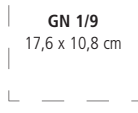
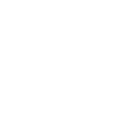
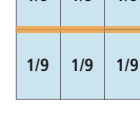
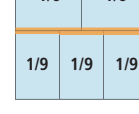
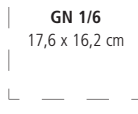
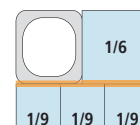
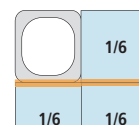
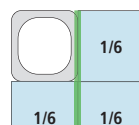
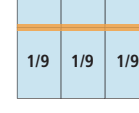
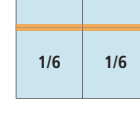
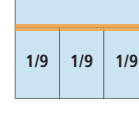
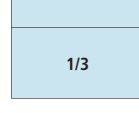
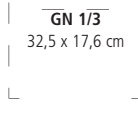
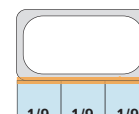
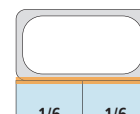
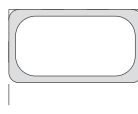
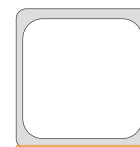
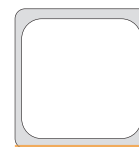
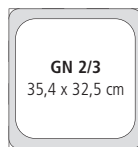
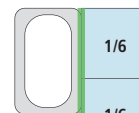
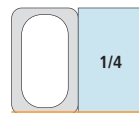
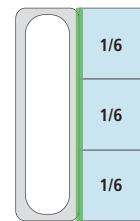
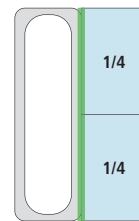
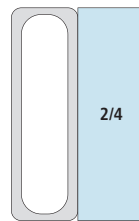
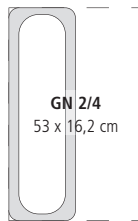
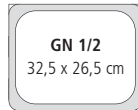
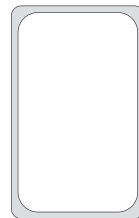



GN-Behälter

GN-container

GN cubetas

GN bacs



	GN	↓ mm	ltr.	cm
81000	2/1	20	5,0	53,0 x 65,0
81095	1/1	10	1,25	53,0 x 32,5
81100	1/1	20	2,5	53,0 x 32,5
81101	1/1	40	5,0	53,0 x 32,5
81109	1/1	55	6,5	53,0 x 32,5
81102	1/1	65	9,0	53,0 x 32,5
81104	1/1	100	13,25	53,0 x 32,5
81106	1/1	150	20,0	53,0 x 32,5
81108	1/1	200	28,0	53,0 x 32,5
81200	1/2	20	1,0	32,5 x 26,5
81201	1/2	40	2,0	32,5 x 26,5
81209	1/2	55	2,8	32,5 x 26,5
81202	1/2	65	4,0	32,5 x 26,5
81204	1/2	100	6,0	32,5 x 26,5
81206	1/2	150	8,75	32,5 x 26,5
81208	1/2	200	11,65	32,5 x 26,5
81300	1/3	20	0,75	32,5 x 17,6
81302	1/3	65	2,5	32,5 x 17,6
81304	1/3	100	4,0	32,5 x 17,6
81306	1/3	150	5,7	32,5 x 17,6
81308	1/3	200	7,0	32,5 x 17,6
81400	1/4	20	0,5	26,5 x 16,2
81401	1/4	40	1,0	26,5 x 16,2
81402	1/4	65	1,8	26,5 x 16,2
81404	1/4	100	2,8	26,5 x 16,2
81406	1/4	150	4,0	26,5 x 16,2
81408	1/4	200	5,5	26,5 x 16,2
81602	1/6	65	1,0	17,6 x 16,2
81604	1/6	100	1,6	17,6 x 16,2
81606	1/6	150	2,4	17,6 x 16,2
81608	1/6	200	3,0	17,6 x 16,2
81502	1/9	65	0,6	17,6 x 10,8
81504	1/9	100	1,0	17,6 x 10,8
81506	1/9	150	1,5	17,6 x 10,8
81700	2/3	20	1,5	35,4 x 32,5
81701	2/3	40	3,0	35,4 x 32,5
81702	2/3	65	5,5	35,4 x 32,5
81704	2/3	100	8,4	35,4 x 32,5
81706	2/3	150	12,5	35,4 x 32,5
81707	2/3	200	18,0	35,4 x 32,5
81800	2/4	20	1,2	53,0 x 16,2
81801	2/4	40	2,4	53,0 x 16,2
81802	2/4	65	3,6	53,0 x 16,2
81804	2/4	100	5,6	53,0 x 16,2
81806	2/4	150	8,7	53,0 x 16,2



**perforierte GN-Behälter**

perforated GN-container  
cubetas GN perforadas  
bacs GN perforés



	GN	↓ mm	cm
81911	1/1	40	53,0 x 32,5
81907	1/1	65	53,0 x 32,5
81908	1/1	100	53,0 x 32,5
81909	1/1	150	53,0 x 32,5
81910	1/1	200	53,0 x 32,5
81901	1/2	65	32,5 x 26,5
81902	1/2	100	32,5 x 26,5
81903	1/2	150	32,5 x 26,5
81904	1/2	200	32,5 x 26,5
81905	2/3	65	35,4 x 32,5
81906	2/3	100	35,4 x 32,5



**GN-Deckel**

GN-lid  
GN tapa  
GN couvercle



**ohne Löffelaussparung**  
without notched edge for spoons  
sin agujero para cucharón  
sans espace pour louche

	GN	cm
81195	1/1	53,0 x 32,5
81295	1/2	32,5 x 26,5
81395	1/3	32,5 x 17,6
81495	1/4	26,5 x 16,2
81695	1/6	17,6 x 16,2
81591	1/9	17,6 x 10,8
81795	2/3	35,4 x 32,5
81895	2/4	53,0 x 16,2



**GN-Deckel**

GN-lid  
GN tapa  
GN couvercle



**mit Löffelaussparung**  
with notched edge for spoons  
con agujero para cucharón  
avec espace pour louche

	GN	cm
81191	1/1	53,0 x 32,5
81292	1/2	32,5 x 26,5
81391	1/3	32,5 x 17,6
81492	1/4	26,5 x 16,2
81692	1/6	17,6 x 16,2
81595	1/9	17,6 x 10,8
81791	2/3	35,4 x 32,5
81891	2/4	53,0 x 16,2



**Die Löffelaussparung mit Prägung verhindert das Zurückfließen von Flüssigkeit auf dem Deckel in den Behälter.**  
The notch for spoon with embossing prevents liquid on the lid from flowing back into the container.

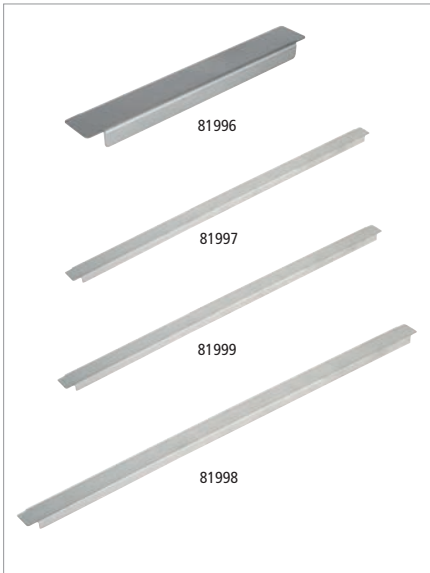

### Adapter / Zwischensteg

adapter  
adaptador  
adaptateur



ermöglicht stabilen Halt von GN-Behältern im CD, rostfreier Chrom-Nickel-Edelstahl  
for fixing GN pans, chrome / nickel stainless steel  
para sujetar las cubetas GN, acero inox  
support stable pour les bacs GN

	cm	
81996 <small>NEW</small>	15,9	längs bei GN 1/4 / lengthwise GN 1/4 longitud GN 1/4 / GN 1/4 dans la longueur
81997	17,6	längs bei GN 1/9 / lengthwise GN 1/9 longitud GN 1/9 / GN 1/9 dans la longueur
81999	32,5	quer bei GN 1/2 / crosswise GN 1/2 de ancho GN 1/2 / GN 1/2 dans la largeur
81998	53	längs bei GN 1/1 / lengthwise GN 1/1 longitud GN 1/1 / GN 1/1 dans la longueur



schwappsicherer Transport!

### GN Transport-Steck-Deckel

GN-lid with silicone seal  
GN tapa hermética con junta  
GN couvercle hermétique avec joint



Silikondichtung, Griffmulde und Loch gegen Unterdruck,  
nicht für Kombidämpfer geeignet

silicone joint, flat handle, vent to compensate  
for pressure, not usable for steam oven  
junta de silicona, asa empotrada, válvula para compensar  
la presión, no se puede utilizar en hornos de vapor  
joint silicone, anse encastrée, valve pour compenser la pression

	GN	cm
80023	1/1	53,0 x 32,5
80024	1/2	32,5 x 26,5
80025	1/3	32,5 x 17,6
80026	1/4	26,5 x 16,2
80027	1/6	17,6 x 16,2
80028	2/4	53,0 x 16,2
80029	2/3	35,4 x 32,5



### GN Abtropfgitter

GN-drainer  
GN escurridor  
GN égouttoir



Abtropfgitter aus Edelstahl für Gastronorm Behälter, passend für GN 1/1 und GN 1/2  
stainless steel GN drainer for GN 1/1 + GN 1/2  
escurridor GN de acero inoxidable para GN 1/1 + GN 1/2  
égouttoir GN en acier inoxydable pour GN 1/1 + GN 1/2

	GN	cm	↑ cm
81117	1/1	45 x 25	1,5
81118	1/2	25 x 19	1,5

## Chafing Dish, GN Container & Transport



### GN-Behälter aus Polycarbonat

GN-container polycarbonate  
GN cubeta policarbonato  
GN bac polycarbonate

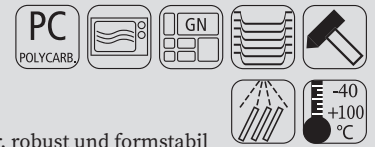

**transparent: Inhalt gut erkennbar, Skalierung in Liter, robust und formstabil**

transparent: content can be seen, liter scale, solid quality

transparente para ver el contenido, graduación en litros, alta calidad

transparent pour voir le contenu, graduation en litres, haute-qualité

	GN	↓ mm	ltr.	cm
82004	1/1	65	8,5	53 x 32,5
82006	1/1	100	13,0	53 x 32,5
82008	1/1	150	19,5	53 x 32,5
82010	1/1	200	26,0	53 x 32,5

	GN	↓ mm	ltr.	cm
82012	1/2	65	3,9	32,5 x 26,5
82014	1/2	100	5,9	32,5 x 26,5
82016	1/2	150	8,9	32,5 x 26,5
82017	1/2	200	11,8	32,5 x 26,5

	GN	↓ mm	ltr.	cm
82018	1/3	65	2,4	32,5 x 17,6
82020	1/3	100	3,6	32,5 x 17,6
82022	1/3	150	5,3	32,5 x 17,6
82023	1/3	200	7,0	32,5 x 17,6

	GN	↓ mm	ltr.	cm
82028	1/4	65	1,7	26,5 x 16,2
82030	1/4	100	2,5	26,5 x 16,2
82032	1/4	150	3,7	26,5 x 16,2
82034	1/4	200	4,8	26,5 x 16,2

	GN	↓ mm	ltr.	cm
82036	1/6	65	1,0	17,6 x 16,2
82038	1/6	100	1,5	17,6 x 16,2
82040	1/6	150	2,2	17,6 x 16,2
82042	1/6	200	2,8	17,6 x 16,2

	GN	↓ mm	ltr.	cm
82050	1/9	65	0,6	17,6 x 10,2
82051	1/9	100	1,0	17,6 x 10,2



### GN-Deckel

GN-lid  
GN tapa  
GN couvercle



	GN	cm
82001	1/1	53,0 x 32,5
82013	1/2	32,5 x 26,5
82019	1/3	32,5 x 17,6
82029	1/4	26,5 x 16,2
82037	1/6	17,6 x 16,2
82059	1/9	17,6 x 10,8



### GN Abtropfgitter

GN drainer  
GN escurridor  
GN égouttoir



	GN	cm
82003	1/1	53,0 x 32,5
82005	1/2	32,5 x 26,5
82007	1/3	32,5 x 17,6



**GN-Behälter aus Polypropylen**

GN-container polypropylene  
GN cubetas polipropileno  
GN bacs polypropilène

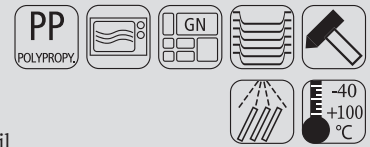

transparent: Skalierung in Liter, robust und formstabil

transparent: liter scale, solid quality

transparente: graduación en litros, alta calidad

transparent: graduation en litres, haute-qualité

	GN	↓ mm	ltr.	cm
82104	1/1	65	8,5	53 x 32,5
82106	1/1	100	13,0	53 x 32,5
82108	1/1	150	19,5	53 x 32,5
82110	1/1	200	26,0	53 x 32,5

	GN	↓ mm	ltr.	cm
82112	1/2	65	3,9	32,5 x 26,5
82114	1/2	100	5,9	32,5 x 26,5
82116	1/2	150	8,9	32,5 x 26,5
82117	1/2	200	11,8	32,5 x 26,5

	GN	↓ mm	ltr.	cm
82118	1/3	65	2,4	32,5 x 17,5
82120	1/3	100	3,6	32,5 x 17,5
82122	1/3	150	5,3	32,5 x 17,6
82123	1/3	200	7,0	32,5 x 17,6

	GN	↓ mm	ltr.	cm
82128	1/4	65	1,7	26,5 x 16,2
82130	1/4	100	2,5	26,5 x 16,2
82132	1/4	150	3,7	26,5 x 16,2
82134	1/4	200	4,8	26,5 x 16,2

	GN	↓ mm	ltr.	cm
82136	1/6	65	1,0	17,6 x 16,2
82138	1/6	100	1,5	17,6 x 16,2
82140	1/6	150	2,2	17,6 x 16,2
82142	1/6	200	2,8	17,6 x 16,2

	GN	↓ mm	ltr.	cm
82150	1/9	65	0,6	17,6 x 10,8
82151	1/9	100	1,0	17,6 x 10,8



**stapelbar**  
stackable

**GN-Deckel**

GN-lid  
GN tapa  
GN couvercle



	GN	cm
82101	1/1	53,0 x 32,5
82113	1/2	32,5 x 26,5
82119	1/3	32,5 x 17,6
82129	1/4	26,5 x 16,2
82137	1/6	17,6 x 16,2
82159	1/9	17,6 x 10,8



## Chafing Dish, GN Container & Transport



### GN-Konvektomatenblech

GN-convection oven trays  
GN cubeta para hornos de convección  
GN bac pour fours à convection



**Oberfläche mit schwarzer Antihafbeschichtung, schwere Qualität**

coated black non stick, heavy quality  
interior con revestimiento antiadherente negro, alta calidad  
revêtement intérieur antiadhérent noir, haute qualité

	GN	↓ mm	cm
88246	1/1	20	53 x 32,5



### GN-Konvektomatenblech - Emailliert

GN-convection oven trays enamelled  
GN cubeta esmaltada para hornos de convección  
GN bac émaillé pour fours à convection



**beidseitig beschichtet mit schwarzer Granit-Emaille, gelochte Ecken, schwere Qualität**

both sides coated with black granite enamel, perforated rim corners, heavy gauge

chapa de hierro esmaltada por ambas caras, color granito negro,  
borde con ángulos perforados, alta calidad

plaque acier émaillé intérieur et extérieur, granité noir,  
bord perforé dans les angles, qualité renforcée

	GN	↓ mm	cm
88244	1/1	20	53 x 32,5
88144	1/1	40	53 x 32,5
88245	1/1	65	53 x 32,5



### Backblech

baking sheet  
bandeja pastelera  
plaque à pâtisserie



**gelocht Ø 3 mm, Materialstärke 1,5 mm, Silikon beschichtet, temperaturbeständig bis 240°C**

perforated Ø 3 mm, coated with silicon, heat resistant up to 240°C  
aluminio con revestimiento de silicona perforada, resistente hasta 240°  
aluminium avec revêtement silicone, perforée, température maxi 240°

	GN	cm
88285	1/1	53 x 32,5



### GN Roste

GN grid  
GN rejilla  
GN grille



**elektrolytisch poliert, Drahtstärke 3 mm, Rahmendraht 6 mm, extra schwere Qualität**

electro-polished, wire thickness 3 mm, frame wire 6 mm, extra heavy quality  
inox pulido electrolítico, grosor alambre 3 mm, grosor marco 6 mm, calidad reforzada  
inox poli électrolytique, fil 3 mm, cadre 6 mm, qualité renforcée

	GN	cm
81199	2/1	65,0 x 53,0
81198	1/1	53,0 x 32,5
81796	2/3	32,5 x 35,4
81296	1/2	32,5 x 26,5



### GN 1/3 Bestecksammler

GN 1/3 container  
GN 1/3 cubeta  
GN 1/3 bac



**mit 2 Haken zum Einhängen an Servier- oder Transportwagen**

container with 2 hooks, to hang on trolleys for cutlery  
cubeta con 2 ganchos para cubiertos, a colgar del carro  
bac à couverts avec 2 crochets, à accrocher au chariot

	GN	↓ mm	cm
11978	1/3	150	32,5 x 17,5





**GN-Behälter**

GN-container  
GN cubetas  
GN bac



	GN	↓ mm	ltr.	cm
82100	1/1	60	7,1	53,0 x 32,5
82200	1/2	60	3,4	32,5 x 26,5
82300	1/3	60	2,0	32,5 x 17,6
82306	2/3	60	4,6	35,4 x 32,5
82301	2/4	60	3,0	53,0 x 16,2



**GN Tablett „FRAMES“**

GN tray  
GN bandeja  
GN plateau



	GN	↑ cm	cm
82355	1/1	2	53,0 x 32,5
82356	1/2	2	32,5 x 26,5
82357	1/3	2	32,5 x 17,6



**GN Tablett**

GN tray  
GN bandeja  
GN plateau



	GN	↑ cm	cm
82201	1/1	2,5	53,0 x 32,5
82202	1/2	2,5	32,5 x 26,5
82203	1/3	2,5	32,5 x 17,6
82204	2/4	2,5	53,0 x 16,2
82205	2/3	2,5	35,4 x 32,5



11195  
2-tlg. Set Tablett + Haube

GN 1/1

**GN 1/1 Buffet-Set „CATERER“**

GN 1/1 buffet set  
GN 1/1 set de bufé  
GN 1/1 set catering: plateau + cloche



**2-teilig:** Tablett + Haube, Tablett fixiert sich auf der Haube - kein Rutschen möglich  
2 pcs. set: tray + cover, tray fixes itself on the cover and can not slip off  
set de 2: bandeja + tapa, la bandeja encaja encima de la tapa para que no se deslice  
set de 2: plateau GN 1/1 réf. + cloche spéciale empilement stable

	cm	↑ cm	GN	fits to
11195	53 x 32,5	10,5	1/1	82201, 82355

## Chafing Dish, GN Container & Transport



### GN-Behälter „ECOLINE“

GN container

GN cubeta

GN bac



mit Stapelnocke

with notching edge

con borde marcado para el apilado

avec rebord pour l'empilage

	GN	↓ mm	ltr.	cm	Farbe / Colour
83759	1/1	65	7,10	53,0 x 32,5	White
83755	2/4	65	3,00	53,0 x 16,2	White
83757	1/2	65	3,40	32,5 x 26,5	White
83753	1/3	65	2,00	32,5 x 17,6	White
83751	1/4	65	1,35	26,5 x 16,2	White
83749	1/6	65	0,80	17,6 x 16,2	White

	GN	↓ mm	ltr.	cm	Farbe / Colour
83758	1/1	65	7,10	53,0 x 32,5	Black
83754	2/4	65	3,00	53,0 x 16,2	Black
83756	1/2	65	3,40	32,5 x 26,5	Black
83752	1/3	65	2,00	32,5 x 17,6	Black
83750	1/4	65	1,35	26,5 x 16,2	Black
83748	1/6	65	0,80	17,6 x 16,2	Black

	GN	↓ mm	ltr.	cm	Farbe / Colour
84300	1/1	100	10,6	53,0 x 32,5	White
84302	2/4	100	4,3	53,0 x 16,2	White
84301	1/2	100	4,7	32,5 x 26,5	White
84303	1/3	100	2,7	32,5 x 17,6	White
84304	1/4	100	1,9	26,5 x 16,2	White
84305	1/6	100	1,0	17,6 x 16,2	White

	GN	↓ mm	ltr.	cm	Farbe / Colour
84306	1/1	100	10,6	53,0 x 32,5	Black
84308	2/4	100	4,3	53,0 x 16,2	Black
84307	1/2	100	4,7	32,5 x 26,5	Black
84309	1/3	100	2,7	32,5 x 17,6	Black
84310	1/4	100	1,9	26,5 x 16,2	Black
84311	1/6	100	1,0	17,6 x 16,2	Black



### GN-Deckel

GN-lid

GN tapa

GN couvercle



	GN	cm
82001	1/1	53,0 x 32,5
82013	1/2	32,5 x 26,5
82019	1/3	32,5 x 17,6
82029	1/4	26,5 x 16,2
82037	1/6	17,6 x 16,2



**GN-Behälter „HIGHLINE“**

GN-container  
GN cubeta  
GN bac



**extrem bruchsticher, glänzende und harte Oberfläche, tiefkühlfest, keinen Temperaturschocks unterziehen, nicht auf heißen Flächen liegen lassen, mit Stapelnocke**

durable, top quality, hard and glossy surface, avoid thermal shocks, do not leave on hot surfaces, with notching edge

duradera, alta calidad, superficie brillante y resistente, hay que evitar los cambios térmicos bruscos, no apoyar en superficies calientes, con borde para apilamiento durable, haute qualité, surface brillante et résistante, éviter les chocsthermiques et ne pas poser sur une surface chaude, encoche pour une louche

	GN	↓ mm	ltr.	cm
83772	1/1	65	7,10	53,0 x 32,5
83770	2/3	65	4,60	35,0 x 32,5
83768	1/2	65	3,40	32,5 x 26,5
83766	2/4	65	3,00	53,0 x 16,2
83764	1/3	65	2,00	32,5 x 17,6
83762	1/4	65	1,35	26,5 x 16,2
83760	1/6	65	0,80	17,6 x 16,2

	GN	↓ mm	ltr.	cm
83773	1/1	100	11,0	53,0 x 32,5
83769	1/2	100	5,50	32,5 x 26,5
83765	1/3	100	3,15	32,5 x 17,6
83763	1/4	100	2,20	26,5 x 16,2
83761	1/6	100	1,25	17,6 x 16,2



11302

**GN 1/1, 2-tlg. Set: Tablett + Haube**

**GN 1/1 Buffet-Set „HOCHSTAPLER“**

GN 1/1 buffet set  
GN 1/1 set de bufé



GN 1/1 kit catering plateau + cloche

**2-teilig: Tablett + Haube, Tablett fixiert sich auf der Haube - kein Rutschen möglich**

2 pcs. set: tray + cover, tray fixes itself on the cover and can not slip off

set de 2 piezas: bandeja + tapa, la bandeja encaja encima de la tapa para que no se deslice

ensemble de 2 pièces: plateau GN 1/1 réf. + cloche spéciale empilement stable

	cm	↑ cm	GN
11302	53 x 32,5	10,5	1/1

**System-Haube für stapelbare Tablett  
wie 11300, 11290 oder 11295**



**GN Abdeckhaube**

GN cover  
GN cubierta  
GN cloche



	cm	↑ cm	* mm	GN
11041	32,5 x 26,5	9,5	3	1/2
11042	53,0 x 32,5	9,5	3	1/1
11043	32,5 x 17,6	10,5	3	1/3
11044	53,0 x 16,2	10,5	3	2/4

# STOP-TOOLS

Die STOP-Funktion verhindert, dass Gabel oder Löffel in das Gefäß rutschen.

The smart STOP-function prevent forks and spoon not to slip into the vessel.

La función STOP evita que los cubiertos se caigan dentro del recipiente. Antideslizante.

La fonction STOP empêche les couverts de glisser dans le récipient.



## Servierlöffel

serving spoon  
cuchara de servicio  
cuillère de service



**Materialdicke 2,5 mm, ergonomischer, rutschfester Griff**  
ergonomic antislip handle  
mango ergonómico antideslizante  
manche ergonomique antidérapante

cm → cm  
00834 10 x 7,5 Griff / handle 17



## Servierlöffel geschlitzt

slotted spoon  
cuchara de servicio  
cuillère de service



**Materialdicke 2,5 mm, ergonomischer, rutschfester Griff**  
ergonomic antislip handle  
mango ergonómico antideslizante  
manche ergonomique antidérapante

cm → cm  
00833 10 x 7,5 Griff / handle 17



## Schöpflöffel

ladle  
cucharón  
louche



**Materialdicke 2,5 mm, ergonomischer, rutschfester Griff**  
ergonomic antislip handle  
mango ergonómico antideslizante  
manche ergonomique antidérapante

∅ cm → cm ltr.  
00832 9 Griff / handle 17 0,08



## Fleischgabel

meat fork  
tenedor de carne  
fourchette à viande



**Materialdicke 2,5 mm, ergonomischer, rutschfester Griff**  
ergonomic antislip handle  
mango ergonómico antideslizante  
manche ergonomique antidérapante

cm → cm  
00831 10,5 x 4 Griff / handle 17



**Servierlöffel**

serving spoon  
cuchara de servicio  
cuillère de service



**ergonomischer, rutschfester Griff**  
ergonomic antislip handle  
mango ergonómico antideslizante  
manche ergonomique antidérapante

00662      cm      → cm  
11 x 7      Griff / handle 25



**Servierlöffel geschlitzt**

serving spoon  
cuchara de servicio  
cuillère de service



**ergonomischer, rutschfester Griff**  
ergonomic antislip handle  
mango ergonómico antideslizante  
manche ergonomique antidérapante

00664      cm      → cm  
11 x 7      Griff / handle 25



**Wender**

turner  
espátula  
spatule



**ergonomischer, rutschfester Griff**  
ergonomic antislip handle  
mango ergonómico antideslizante  
manche ergonomique antidérapante

00668      cm      → cm  
10 x 8      Griff / handle 25



**Schöpflöffel**

ladle  
cucharón  
louche



**ergonomischer, rutschfester Griff**  
ergonomic antislip handle  
mango ergonómico antideslizante  
manche ergonomique antidérapante

00670      cm      → cm      ltr.  
9 x 8      Griff / handle 25      0,11



**Fleischgabel**

meat fork  
tenedor de carne  
fourchette à viande



**ergonomischer, rutschfester Griff**  
ergonomic antislip handle  
mango ergonómico antideslizante  
manche ergonomique antidérapante

00666      cm      → cm  
10 x 3,5      Griff / handle 25



**Schöpflöffel „PROFI“**

ladle  
cacillo  
louche



	∅ cm	→ cm	ltr.
00711	6	Griff / handle 28	0,050
00712	7	Griff / handle 30	0,080
00713	8	Griff / handle 32	0,125
00714	9	Griff / handle 33	0,150
00715	10	Griff / handle 35	0,250
00716	11	Griff / handle 36	0,300



**Schaumlöffel „PROFI“**

skimmer  
espumadera  
écumoire



	∅ cm	→ cm
00721	10	Griff / handle 34
00722	12	Griff / handle 37
00723	14	Griff / handle 40



**Wender „PROFI“**

turner  
espátula  
spatule



	cm	→ cm
00730	10 x 11,5	Griff / handle 38



**Servierlöffel „PROFI“**

serving spoon  
cuchara de servicio  
cuillère de service



	cm	→ cm	
00671	11 x 7	Griff / handle 29	geschlitzt / slotted
00672	11 x 7	Griff / handle 29	



**Spaghettilöffel „PROFI“**

spaghetti spoon  
cuchara de espaguetis  
cuillère à spaghettis



	cm	→ cm
00673	10 x 7	Griff / handle 29



**Salat- / Servierlöffel „BANQUET“**

salad spoon / serving spoon  
cuchara para ensalade / cuchara de servicio  
cuillère à salade / cuillère de service



	cm	→ cm
00588	6,0 x 5	Griff / handle 17
00590	7,5 x 6	Griff / handle 21

**Salatgabel „BANQUET“**

salad fork  
tenedor de servicio para ensalada  
fourchette de service pour la salade



	cm	→ cm
00589	6,0 x 5	Griff / handle 17
00591	7,5 x 6	Griff / handle 21

**Chafing Dish Löffel „BANQUET“**

serving spoon  
cuchara para servir  
cuiller de service



	cm	→ cm
00592	11 x 6,5	Griff / handle 24
00593	11 x 6,5	Griff / handle 24 geschlitzt / slotted

**Dressinglöffel „BANQUET“**

dressing spoon  
cuchara de aliño  
cuillère à vinaigrette



	cm	→ cm
00594	6 x 4	Griff / handle 30

**Schöpflöffel „BANQUET“**

ladle  
cucharón  
louche



	cm	→ cm
00595	8,5 x 7,5	Griff / handle 24

**Fleischgabel „BANQUET“**

meat fork  
tenedor de carne  
fourchette à viande



	cm	→ cm
00596	8 x 2,5	Griff / handle 13

**Serviergabel „BANQUET“**

fork  
tenedor de servicio  
fourchette de service



	cm	→ cm
00597	9 x 4	Griff / handle 21

**Pfannenwender „BANQUET“**

turner  
espatula  
spatule



	cm	→ cm
00587	10 x 7,5	Griff / handle 21



Servier- / Transportwagen

serving trolley  
carro de servicio  
chariot de service



Gestell aus Vierkantröhr 25 x 25 mm, Ablagefläche innen 84 x 44,5 cm, Bodenfläche 90 x 50 cm, auf Unterseite schalldämmend beschichtet, Abstand zwischen den Böden 28 cm / 29 cm, mit 4 Lenkrollen Ø 12,5 cm, alle mit Feststellern, Lieferung demontiert, einfache Montage, Tragfähigkeit 33 kg je Boden

frame rectangular bar 25 x 25 mm, shelf board inside 84 x 44,5 cm, shelf board outside 90 x 50 cm, undersurface coated sound-damping, distance between the boards 28 cm / 29 cm, with 4 swivel wheels Ø 12,5 cm, all with brakes, unassembled, simple assembly, max load 33 kg per shelf

estructura tubo cuadrado 25 x 25 mm, útiles int. por piso 84 x 44,5 cm. ext. al suelo 90 x 50 cm revestimiento para absorber ruidos distancia entre pisos 28 cm / 29 cm, 4 ruedas giratorias 12,50 cm, con frenos, se sirve desmontado, montaje fácil, carga máx. 33 kg por piso

structure en tube carré 25x25 mm, 3 niveaux dimensions utiles 84x44,5 cm, encombrement au sol 90x50 cm, avec revêtement en partie inférieure pour absorber le bruit, distance entre niveaux 28 cm / 29 cm, 4 roues pivotantes 12,5 cm, avec frein, livré démonté, montage aisé, max. 33 kg de charge par niveau

	cm	↑ cm
71440	96 x 50	94



Servier- / Transportwagen

service trolley  
carro de servicio  
chariot de service



mit 3 Borden, Bordmaße ca. 83 x 51 cm, Abstand zwischen den Borden ca. 26 cm, Tragfähigkeit 120 kg, 4 Lenkrollen, davon 2 feststellbar, Lieferung demontiert, einfache Montage

with 3 trays, trays approx. 83 x 51 cm, size between the trays approx. 26 cm, total load capacity 120 kg, 4 wheels with 2 brakes, unassembled, simple assembly

con 3 bandejas inox mate, aprox. 83 x 51 cm, la medida entre bandejas aprox. 26 cm capacidad total 120 kg, 4 ruedas con 2 frenos, construcción robusta, montaje fácil

3 niveaux, approx. 83x51 cm chacun, distance entre niveaux 26 cm, capacité maxi 120 kg au total, 4 roues dont 2 avec frein, construction robuste, montage facile

	cm	↑ cm
11979	91 x 59	93



Servier- / Transportwagen

service trolley  
carro de servicio  
chariot de service



mit 2 Borden, Bordmaße ca. 83 x 51 cm, Abstand zwischen den Borden ca. 56 cm, Tragfähigkeit 80 kg, 4 Lenkrollen, davon 2 feststellbar, Lieferung demontiert, einfache Montage

with 2 trays, trays approx. 83 x 51 cm, size between the trays approx. 56 cm, total load capacity 80 kg, 4 wheels with 2 brakes, unassembled, simple assembly

con 2 bandejas de acero inoxidable mate, aprox. 83 x 51 cm, la medida entre bandejas aprox. 56 cm, capacidad total 80 kg, 4 ruedas, con 2 frenos, construcción robusta, montaje fácil

2 niveaux, approx. 83x51 cm chacun, distance entre niveaux 56 cm, capacité maxi 80 kg au total, 4 roues dont 2 avec frein, construction robuste, montage facile

	cm	↑ cm
11977	91 x 59	93





### GN 1/1 Regalwagen

GN 1/1 trolley  
carro GN 1/1  
GN 1/1 chariot



mit 15 Doppelauflegeschieben, zum Transport von bis zu 30 GN-Tablets GN 1/2 oder 15 GN-Behältern bis GN 1/1 (Längseinschub), bei einem Stapelabstand von 75 mm, mit 4 Lenkrollen, 2 mit Feststellern, Tragfähigkeit 100 kg

15 double bars, for transporting up to 30 trays GN 1/2 or 15 GN-containers up to GN 1/1, size between the trays 75 mm, 4 swivel wheels, 2 equipped with brakes total load capacity 100 kg

15 pares de rieles dobles para el transporte de hasta 30 bandejas o 15 cubetas GN 1/1 (apertura por el lado estrecho) distancia entre las bandejas de 75 mm, 2 ruedas giratorias con frenos, carga máxima 100 kg

15 rails doubles pour maxi 30 plateaux GN 1/2 ou 15 plateaux GN 1/1 (ouverture sur le côté étroit 32,5cm), espace entre plateaux 75 mm, 2 roues pivotantes avec frein, charge maxi 100 kg

	cm	↑ cm
71441	55 x 38,5	173,5



mit beidseitiger Kipp- und Durchschubsicherung



### Servier- / Transportwagen

serving trolley  
carro de servicio  
chariot de service



Aluminiumrahmen, 3 Böden, Abstand zwischen den Böden 31 cm, mit 4 Lenkrollen, alle mit Feststellern, Tragfähigkeit: ca. 80 kg je Boden, 240 kg insgesamt, demontiert, einfache Montage, Lieferung ohne Container und Dekoration

frame aluminium, 3 shelves, distance between shelves 31 cm, 4 swivel wheels, all equipped with brakes, max. load per shelf 80 kg, 240 kg total, demounted, easy to mount, delivery without containers and decoration

marco aluminio, 3 pisos, distancia entre cada piso 31 cm, 4 ruedas giratorias, las 4 con frenos, carga máxima por bandeja 80 kg, 240 kg en total, se sirve desmontado, fácil de montar (se entrega sin contenedores ni decoración)

chassis aluminium, 3 étages, distance entre niveaux 31 cm, 4 roues pivotantes, toutes avec frein, charge maximum 80 kg par niveau, 240 kg au total, livré démonté, montage facile (livré sans récipients ni décoration)

	cm	↑ cm
11945	108 x 50	96



### Container

container  
contenedor  
récipient



zum Einhängen, passend zum Servier- / Transportwagen 11945

to hang up, suitable serving trolley 11945

para colgar, adaptado para el carro ref. 11945

à suspendre, pour chariot de service 11945

	cm	↑ cm	ltr.
11946	33 x 23	56,5	42
11947	33 x 23	17,5	13



**GN 1/1 Besteckbehälter**

GN 1/1 dispenser GN  
GN 1/1 dispensador de cubiertos  
GN 1/1 bac à couverts



in Handarbeit geflochten, 4 Mulden, Kunststoff-Geflecht, Drahtgestell, braun-schwarz  
wickerwork, 4 compartments, with reinforced chromed wire structure, brown-black  
cesta trensada a mano, 4 compartimentos, de plástico, con bastidor cromado reforzado, marrón oscuro  
corbeille tressée à main, 4 compartiments, en plastique, cadre acier chromé renforcé, couleur marron foncé

	cm	↑ cm	Farbe / Colour
11966	53 x 32,5	9	



**GN 1/1 Besteckbehälter „BUFFET“**

GN 1/1 cutlery dispenser  
GN 1/1 dispensador de cubiertos  
GN 1/1 bac à couverts



4 Mulden, Kunststoff-Geflecht, Drahtgestell, beige

4 troughs, wickerwork, wire, beige

4 huecos, trabajo de cestería

4 compartiments, plastique tressé, cadre acier chromé renforcé, couleur osier naturel

	cm	↑ cm	Farbe / Colour
11965	53 x 32,5	10	



**GN 1/1 Besteckbehälter**

GN 1/1 cutlery tray / box stand  
GN 1/1 dispensador de cubiertos  
GN 1/1 bac à couverts



	cm	↑ cm	Farbe / Colour
11955	53 x 32,5	10	



**GN 1/1 Besteckkasten**

cutlery box GN 1/1  
GN 1/1 dispensador de cubiertos  
GN 1/1 bac à couverts



	cm	↑ cm	Farbe / Colour
11960	53 x 32,5	10	



**Besteckständer „TRIPLE TOWER“**

cutlery basket  
cesta para cubiertos  
égouttoir à couverts



4-teiliges Set: 1 Gestell + 3 Köcher

4 pcs. set: 1 frame + 3 baskets

set de 4 piezas: 1 estructura + 3 cubiertos

set de 4 éléments: 1 structure + 3 corbeille

	cm	↑ cm	Farbe / Colour
11466	18 x 26	43	
11467	18 x 26	43	



**Besteckköcher**  
cutlery basket  
cesta para cubiertos  
corbeille à couverts



	cm	↑ cm	Farbe / Colour
84535	12 x 12	16	White
84536	12 x 12	16	Black



**Besteckbehälter**  
cutlery basket  
recipiente para cubiertos  
récipients pour couverts



4 Löcher inkl. 4 Edelstahl Köcher  
4 holes incl. 4 stainless baskets  
4 agujeros, incl. 4 cestas de acero  
4 places, avec 4 corbeille inox

	cm	↑ cm	Farbe / Colour
93321	27 x 27	15	Dark Brown



**Besteckbehälter**  
cutlery basket  
dispensador de cubiertos  
présentoir à couverts



**matt poliert**  
satin polished finish  
inox mate (sin cubiertos)  
inox mat

	cm	↑ cm	
11994	26,0 x 30 Ø 10	20	4 Löcher inkl. Köcher (Kunststoff) 4 holes incl. dispensers (plastic) 4 agujeros incl. dispensador plástico 4 places, avec 4 récipients (plastique)
11997	37,5 x 30 Ø 10	20	6 Löcher ohne Köcher 6 holes without dispensers 6 agujeros sin dispensador de plástico 6 places, sans récipients



**Besteckköcher**  
cutlery basket  
cesta para cubiertos  
corbeille à couverts



	Ø cm	↑ cm	
11998	9,7	13,7	Kunststoff weiß / white plastic plástico blanco / plastique blanc
11999	9,7	13,7	matt poliert / satin polished finish acero inoxidable / inox

11998  
Köcher weiß  
PE white

11999  
Köcher Edelstahl  
stainless steel



**Besteckbehälter „ELEMENT“**

cutlery bin  
recipiente para cubiertos  
récipients pour couverts



mit Abflussloch, mit Besteck Logo, Bodeneinlagen aus Silikon zum Schonen der Messerspitzen, möbelschonende Unterseite

with drain hole, with cutlery logo, silicone floor inserts for saving the points of knives, with non-scratching undersurface

con orificio de drenaje, con logotipo de cubertería, soporte de silicona para proteger las puntas de los cuchillos, con base antirrayaduras

avec le trou de drainage, avec le logo de coutellerie, insert de silicone pour protéger les pointes des couteaux, avec base revêtue antirayures

	Ø cm	↑ cm	Logo
00018	11	14	fork / knife / spoon



NEW

11935

11936

11937

**Besteckbehälter „ELEMENT“**

cutlery bin  
recipiente para cubiertos  
récipients pour couverts



mit Abflussloch, mit weißem Logo, Bodeneinlage aus Silikon zum Schonen des Bestecks, möbelschonende Unterseite

with drain hole, with white logo, silicone floor inserts for saving the cutlery, with non-scratching undersurface

con orificio de drenaje, con logotipo blanco, base de silicona para proteger la cubertería, con base anti rayaduras

avec trou de drainage, avec logo blanc, insert de silicone pour protéger la coutellerie, avec revêtement antirayures

	Ø cm	↑ cm	Logo
11935	12	14	fork
11936	12	14	knife
11937	12	14	spoon



NEW

**Besteckbehälter „ACACIA“**

cutlery bin  
recipiente para cubiertos  
récipients pour couverts



Akazienholz natur

acacia wood nature

madera de acacia natural

bois d'acacia naturelle

	cm	↑ cm	Logo
11939	14 x 14	15	fork / knife / spoon



**Besteckbehälter „VINTAGE“**

cutlery bin  
recipiente para cubiertos  
récipients pour couverts

Akazienholz vintage weiß  
acacia wood, vintage white  
madera de acacia, blanca vintage  
bois d'acacia, blanc vintage



	cm	↑ cm	Logo
11938	14 x 14	15	fork / knife / spoon



**Besteckkorb „ECONOMIC“**

cutlery dispenser  
dispensador de cubiertos  
corbeille à couverts

in Handarbeit geflochten  
wickerwork  
trensado a mano  
tressage à main



	Ø cm	↑ cm	Farbe / Colour
40130	12	15	beige
40007	12	15	black
40012	12	15	brown
40013	12	15	anthracite



**Besteckkorb „ECONOMIC“**

cutlery dispenser  
dispensador de cubiertos  
corbeille à couverts

in Handarbeit geflochten  
wickerwork  
trensado a mano  
tressage à main



	cm	↑ cm	Farbe / Colour
40131	27 x 10	4,5	beige
40009	27 x 10	4,5	black
40010	27 x 10	4,5	brown
40011	27 x 10	4,5	anthracite

## Chafing Dish, GN Container & Transport



### Besteckständer cutlery basket cesta para cubiertos égouttoir à couverts



	Ø cm	↑ cm
11921	10	10,0
11922	12	13,5



### Sortierbox „MULTI“ shape sorter caja surtida boîte de tri



inklusive 3 herausnehmbare Trennwände, 4 Kammern  
including 3 removable divider, 4 chambers  
con 3 divisores extraíbles, 4 compartimentos  
avec 3 parois de séparation amovibles, 4 compartiments

	cm	↑ cm	ltr.	Farbe / Colour
84531	31,5 x 17,5	7	2,1	White
84532	31,5 x 17,5	7	2,1	Black



### Eier-Box eggs box caja para huevos boîte à oeufs



mit luftdichtem Deckel, für 4 Lagen à 30 Eier, Lieferung inkl. 8 Lagen, Größe Lage: 28 x 28 cm  
with airtight cover, capacity: 4 trays of 30 eggs, delivery with 8 trays, size of tray: 28 x 28 cm  
capacidad para 4 bandejas de 30 huevos, tapa hermética, se entrega con 8 bandejas, formato bandejas 28 x 28 cm, apto para lavavajillas  
pour 4 plateaux de 30 oeufs chacun, apte pour 4 plateaux plats, couvercle hermétique, livré avec 8 plateaux, dimension plateau 28x28 cm, lavable en lave-vaisselle

	cm	↑ cm	GN
82419	35,4 x 32,5	20	2/3

10 Lagen / 10 trays / 10 bandejas / 10 plateaux

82420



### Rechteckschalen container cubeta bac



	cm	↑ cm	ltr.
11941	30 x 21,0	6,5	2
11942	34 x 23,5	7,0	3
11943	48 x 33,0	8,0	8



Wanne  
container  
cubeta  
bac



	cm	↑ cm	ltr.
11940	61 x 44	15	25



Geschirrwanne  
container  
cubeta para vajilla  
bac à vaisselle



	cm	↑ cm
11950	55 x 42	14



Serviertablett „RUTSCHFEST“

tray non-slip  
bandeja antideslizante  
plateau antiglisse



rutschfeste Oberfläche  
non-slip surface  
superficie anti-deslizante  
surface antidérapante

	cm	↑ cm	GN	Farbe / Colour
00502	53 x 32,5	1,5	1/1	
00508	46 x 36,0	2		
00505	53 x 32,5	1,5	1/1	
00503	53 x 37,0	1,5		



Fast Food Tablett

snack tray  
bandeja autoservicio y snacks  
plateau self-service et snacks



	cm	↑ cm	GN	Farbe / Colour
00530	35 x 27,0	2		
00535	41 x 30,5	2		
00540	45 x 35,5	2		
00552	53 x 32,5	2	1/1	

	cm	↑ cm	GN	Farbe / Colour
00531	35 x 27,0	2		
00536	41 x 30,5	2		
00541	45 x 35,5	2		
00553	53 x 32,5	2	1/1	

	cm	↑ cm	GN	Farbe / Colour
00532	35 x 27,0	2		
00537	41 x 30,5	2		
00542	45 x 35,5	2		
00554	53 x 32,5	2	1/1	

	cm	↑ cm	GN	Farbe / Colour
00533	35 x 27,0	2		
00538	41 x 30,5	2		
00543	45 x 35,5	2		
00555	53 x 32,5	2	1/1	







# Bar, Café Drinkware

**Sektkühler**  
**Shaker**  
**Barmaß**  
**Aschenbecher**  
**Tabletts**

cubiteras  
cocteleras  
medidores jigger  
ceniceros  
bandejas

champagne bowls  
shakers  
jiggers  
ashtrays  
trays

seaux à champagne  
shakers  
mesures jigger  
cendriers  
plateaux



**Flaschenkühler „MOSCOW MULE“**

bottle cooler  
enfriador de botellas  
rafraîchisseur de bouteilles

Edelstahl-Flaschenkühler, Antik-Kupfer-Look  
stainless steel cooler, copper antique look  
enfriador de acero inoxidable, cobre estilo antiguo  
rafraîchisseur en acier inox, cuivre style antique



	Ø cm	↑ cm	ltr.	
93330	20	21	5	copper-antique-hammered



**Wein- / Sektkühler „TROPHY“**

wine / champagne bowl  
cubitera para vino y cava  
seau à vin ou champagne

hochglanzpoliert, mit Griffen, Fuß Ø 18,5 cm,  
mirror polished finish, with handles, foot Ø 18,5 cm  
pulido brillante, 2 asas, pie Ø 18,5 cm  
brillant, 2 anses, pied Ø 18,5 cm



	Ø cm	↑ cm	ltr.	
36092	23	24	5	stainless-steel
36093	23	24	5	copper-look



**Wein- / Sektkühler**

wine / champagne bowl  
cubitera para vino y cava  
seau à vin ou champagne

innen mattiert, außen hochglanz, mit massiven Knopf-Griffen,  
extra stabiler ingerollter Rand, schwere Ausführung  
outside mirror polished finish, inside satin polished finish,  
with solid knob handles, rolled edge, heavy quality  
acabado pulido brillante, asas de botón robustas, borde redondeado, alta calidad  
brillant, 2 poignées robuste en forme de bouton, bord arrondi, haute qualité



	Ø cm	↑ cm	ltr.
36028	21,5 / 16	22	4



**Wein- / Sektkühler**

wine / champagne bowl  
cubitera para vino y cava  
seau à vin ou champagne

innen mattiert, außen poliert, mit massiven Griffen, Rand ingerollt  
outside mirror polished finish, inside satin polished finish, with massive handles, rolled edge  
pulido mate, 2 asas macizas, borde redondeado  
finition mate, 2 anses massives, bord rond



	Ø cm	↑ cm	ltr.
36025	21 / 15	21	3,5



**Mini-Eiseimer / Mini-Sektkühler**

ice bucket  
cubitera clásica  
seau à glaçons classique



	Ø cm	↑ cm	ltr.
36003	10,5	10	0,5
36004	13,0	13	1,0

hot price



Wein- / Sektkühler

wine / champagne bowl  
cubitera para vino y cava  
seau à vin ou champagne



aussen hochglanzpoliert, innen matt poliert, mit Ring-Griffen

outside mirror polished finish, inside satin polished finish, with ring handles

exterior pulido brillante, interior efecto satinado con 2 asas anillos

extérieur brillant, intérieur satin, avec 2 anneaux

	Ø cm	↑ cm	ltr.
36020	20 / 15	19	3



Wein- / Sektkühler

wine / champagne bowl  
cubitera para vino y cava  
seau à vin ou champagne



matt poliert, Hohlgriffe

satin polished finish, hollow handles

acabado pulido satinado, con asas huecas

finition mate, 2 boutons creux

	Ø cm	↑ cm	ltr.
36021	20 / 15	20,5	4



Wein- / Sektkühler „HAMMERSCHLAG“

wine / champagne bowl  
cubitera para vino y cava  
seau à vin ou champagne



hochglanzpoliert, mit massiven Ring-Griffen, eingerollter Rand

mirror polished finish, with solid ring handles, rolled edge, hammered

acabado pulido brillante, con 2 anillos macizos, borde redondeado, repujado

brillant, 2 anneaux massifs, bord arrondi, surface martelée

	Ø cm	↑ cm	ltr.
36026	21 / 17	21,5	4

hot price



Wein- / Sektkühler

wine / champagne bowl  
cubitera para vino y cava  
seau à vin ou champagne



glasklarer Rand, transparent gefrostet

edge transparent, body transparent frosted

borde transparente, cuerpo transparente efecto glaseado

bord transparent, corps finition mate

	Ø cm	↑ cm	ltr.
36066	22 / 14	23	4



Wein- / Sektkühler

wine / champagne bowl  
cubitera para vino y cava  
seau à vin ou champagne



glasklar, mit Tragegriff

transparent, handle on the side

transparente, con un asa en el lateral

transparent, avec poignée

	cm	↑ cm	ltr.
36055	23 x 22	27,5	3



**Wein- / Sektkühler**

wine / champagne bowl  
 cubitera para vino y cava  
 seau à vin ou champagne



mit seitlichen Griffen, transparent  
 with lateral handles, transparent  
 con asas laterales  
 avec poignées latérales

	cm	↑ cm	ltr.
36081	20 x 20	20	4,5



**Ständer für Wein- / Sektkühler**

stand for wine / champagne bowl  
 pie porta champañera / vino  
 pied pour seau à champagne / vin



hochglanzpoliert, schwerer standsicherer Fuß, Innendurchmesser der Schale Ø 15 cm  
 mirror polished finish, heavy foot, inner bowl Ø 15 cm  
 acabado pulido efecto brillante, bol interior de Ø 15 cm  
 brillant, intérieur support Ø 15 cm

	Ø cm	↑ cm
36068	15 / 28	68



**Ständer für Wein- / Sektkühler**

stand for wine / champagne bowl  
 pie porta champañera / vino  
 pied pour seau à champagne / vin



hochglanzpoliert, schwerer standsicherer Fuß, Innendurchmesser der Schale Ø 17,5 cm  
 mirror polished finish, heavy foot, inner bowl Ø 17,5 cm  
 acabado pulido efecto brillante, bol interior de Ø 17,5 cm  
 brillant, intérieur support Ø 17,5 cm

	Ø cm	↑ cm
36069	17,5 / 26,5	73



**Wein- / Sektkühler no. 36028**

wine / champagne bowl no. 36028  
 cubitera para vino y cava no. 36028  
 seau à vin ou champagne no. 36028



**Tischhalterung für Sektkühler**

champagne bucket table holder  
 soporte champañera universal  
 porte-seau à champagne



aus 8 mm starkem Stahldraht, passen zu allen lieferbaren Sektkühlern, innen Ø-Ring: 18 cm  
 8 mm chrome plated wire, suitable for all available champagne buckets  
 alambre cromado 8 mm, para todas las champañeras  
 fil chromé 8 mm, pour tous les seaux à champagne

	cm	↑ cm
30332	49 x 20	17



**Wein- / Sektkühler**  
 wine / champagne bowl  
 cubitera para vino y cava  
 seau à vin ou champagne



gehämmerte Oberfläche mit 2 seitlichen Eingriffen  
 hammered surface with 2 handles on the side  
 superficie martillada con 2 asas  
 surface martelée avec 2 poignées

	cm	↑ cm	ltr.	Farbe / Colour
36111	30 x 23,5	23	7	copper-look



**Wein- / Sektkühler**  
 wine / champagne bowl  
 cubitera para vino y cava  
 seau à vin ou champagne



gehämmerte Oberfläche mit 2 seitlichen Eingriffen  
 hammered surface with 2 handles on the side  
 superficie martillada con 2 asas  
 surface martelée avec 2 poignées

	cm	↑ cm	ltr.	Farbe / Colour
36112	30 x 23,5	23	7	gunmetal-look

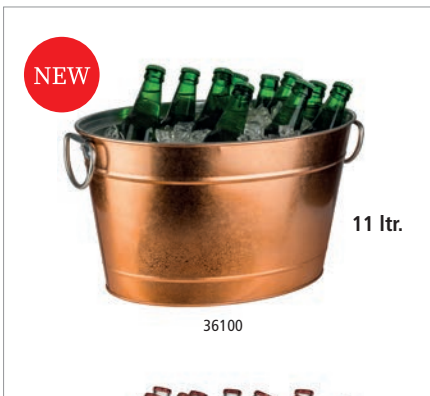

**Getränkewanne „TIN“**  
 beverage tub  
 barreño botellines  
 bassine à glace



Metall verzinkt, mit Kunststoffeinsatz, mit massiven Ring-Griffen  
 galvanised metal, with plastic insert, with solid ring handles  
 metal galvanizado, con inserto de plástico, con 2 anillos macizos  
 métal galvanisé, avec insert en plastique, 2 anneaux massifs

	Ø cm	↑ cm	ltr.	Farbe / Colour
36100	40 x 28	22	11	copper-look
36101	40 x 28	22	11	black-metal-look



mit Kunststoffeinsatz  
 with plastic insert  
 con inserto de plástico  
 avec insert en plastique



Kreidestift zum Beschriften  
 chalk marker for writing  
 S. 312



**Getränkewanne „TIN“**  
 beverage tub  
 barreño botellines  
 bassine à glace



Metall verzinkt, mit Kunststoffeinsatz, mit massiven Ring-Griffen  
 galvanised metal, with plastic insert, with solid ring handles  
 metal galvanizado, con inserto de plástico, con 2 anillos macizos  
 métal galvanisé, avec insert en plastique, 2 anneaux massifs



	Ø cm	↑ cm	ltr.
36095	40 x 28	22	11
36096	50 x 32	23	18

2 sizes available with ring handles



### Champagnerkühler

champagne bowl  
cubo champañera  
seau à champagne



hochglanzpoliert, Rand matt poliert  
mirror polished finish, edge satin polished finish  
acabado pulido brillante, borde satinado  
brillant, bord mat

	Ø cm	↑ cm	ltr.
36046	45 / 21	23	12



### Champagnerkühler

champagne bowl  
cubo champañera  
seau à champagne



hochglanzpoliert, Lieferung ohne Gläser-Ring  
mirror polished finish, delivery without holder  
acabado efecto brillante, se entrega sin el aro colgador para copas  
brillant, livré sans le support à flûtes

	Ø cm	↑ cm	ltr.
36045	40,5 / 27,5	22,5	13,5



### Champagnerkühler

champagne bowl  
cubo champañera  
seau à champagne



außen hochglanzpoliert, innen matt poliert, mit vergoldeten Griffen  
outside mirror polished finish, inside satin polished finish, with gold plated handles  
exterior pulido brillante, interior satinado  
extérieur brillant, intérieur satin

	Ø cm	↑ cm	ltr.
36047	42 / 27	28	20



### Flaschenkühler „BRIDGE“

bottle cooler  
enfriador de botellas  
rafraîchisseur de bouteilles



doppelwandig für beste Isolierung, außen poliert, innen mattiert  
double wall cooler keeps the temp. for a long time, outs. mirror polished, inside matt finish  
champañera inox de doble pared, interior mate, exterior brillante  
seau inox double paroi, maintient le froid plus longt., intérieur mat, extérieur poli brillant

	Ø cm	↑ cm	ltr.
36077	31	19	10



### Konferenzkühler „BRIDGE“ no. 13985

bottle cooler no. 13985  
enfriador no. 13985  
rafraîchisseur no. 13985



### Champagnerkühler

champagne bowl  
cubo champañera  
seau à champagne

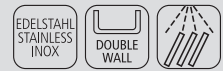

hochglanzpoliert, doppelwandig  
mirror polished finish, double wall  
acabado pulido brillante con doble pared  
brillant, double paroi

	Ø cm	↑ cm	ltr.
36044	44 / 25	24	10,5



### Flaschenkühler / Getränkeschale

bottle cooler / bowl  
enfriador de botella  
rafraîchisseur de bouteille



mit seitlichen Griffen, transparent  
with lateral handles, transparent  
con asas laterales  
avec poignées latérales

	cm	↑ cm	ltr.
36082	35,5 x 35,5	20	16



### Wein- / Sektkühler

wine / champagne bowl  
cubitera para vino y cava  
seau à vin ou champagne



mit seitlichen Griffen, transparent  
with lateral handles, transparent  
con asas laterales  
avec poignées latérales

	cm	↑ cm	ltr.
36087	32 x 21,5	24,5	7



### Wein- / Sektkühler

wine / champagne bowl  
cubitera para vino y cava  
seau à vin ou champagne



glasklar, für bis zu 6 Flaschen geeignet  
transparent, suitable for up to 6 bottles  
transparente, para máximo 6 botellas  
transparent, maxi 6 bouteilles

	cm	↑ cm	ltr.
36057	47 x 28	23	10



### Wein- / Sektkühler

wine / champagne bowl  
cubitera para vino y cava  
seau à vin ou champagne



mit 2 seitlichen Eingriffen  
with 2 handles on the side  
con 2 asas  
avec 2 poignées

	cm	↑ cm	ltr.
36048	35 x 27	25,5	6
36052	27 x 20	21	3



**Wein- / Sektkühler**  
 wine / champagne bowl  
 cubitera para vino y cava  
 seau à vin ou champagne



**mit 2 seitlichen Eingriffen**  
 with 2 handles on the side  
 con 2 asas  
 avec 2 poignées

	cm	↑ cm	ltr.	Farbe / Colour
36054	35 x 27	25,5	6	■
36053	27 x 20	21,0	3	■



**Wein- / Sektkühler**  
 wine / champagne bowl  
 cubitera para vino y cava  
 seau à vin ou champagne



**glasklar, für zwei Flaschen**  
 transparent, for two bottles  
 transparente, para 2 botellas  
 transparent, pour 2 bouteilles

	cm	↑ cm	ltr.
36056	30,5 x 21,5	26	4



**Flaschenkühler „COPPER“**  
 bottle cooler  
 enfriador de botella  
 rafraîchisseur de bouteille

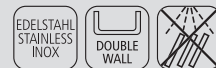

**Hammerschlagoptik, doppelwandig für beste Isolierung, für 0,7 - 1,5 Liter-Flaschen**  
 double wall cooler keeps the temperature for a long time, hammered look, for 0,7 - 1,5 ltr. bottles  
 doble pared para mantener el frío largo tiempo, botellas de 0,7 - 1,5 ltr.  
 double paroi pour une meilleure conservation de la température, pour bouteilles de 0,7 à 1,5 l.

	Ø cm	↑ cm	Farbe / Colour
36074	12 / 10	20	■

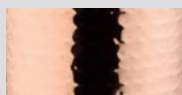

**1:1 Oberflächenansicht**  
 1:1 structural view



für 0,7 - 1,5 Liter-Flaschen  
 for 0,7 - 1,5 ltr. bottles

36030

36038

für 0,7 - 1,5 Liter-Flaschen  
 for 0,7 - 1,5 ltr. bottles

**Flaschenkühler**  
 bottle cooler  
 enfriador de botella  
 rafraîchisseur de bouteille

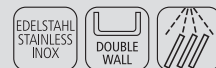

**matt poliert, doppelwandig für beste Isolierung**  
 satin polished finish, double wall cooler keeps the temperature for a long time  
 acero inoxidable mate con doble pared para mantener el frío largo tiempo  
 inox mat, double paroi pour une meilleure conservation de la température

	Ø cm	↑ cm
36030	12,0 / 10	20
36038	12,5 / 10	19





### Flaschenkühler

bottle cooler  
enfriador de botella  
rafraîchisseur de bouteille



transparent, doppelwandig für beste Isolierung, mit Chromrand

transparent, double wall cooler keeps the temperature for a long time, with chrome edge  
transpar., doble pared mantiene la temperatura por largo tiempo, borde superior cromado  
transparent, bord chromé brillant, double paroi pour maintien en température

	Ø cm	↑ cm	Farbe / Colour
36032	12 / 10	23	
36034	12 / 10	23	



### Flaschenkühler „PURE“

bottle cooler  
enfriador de botella  
rafraîchisseur de bouteille



doppelwandig für beste Isolierung, glasklar / doublewall, clear / doble pared / double paroi

	Ø cm	↑ cm
36063	13,5 / 10,5	23



### Flaschenkühler „CRYSTAL“

bottle cooler  
enfriador de botella  
rafraîchisseur de bouteille



doppelwandig für beste Isolierung, glasklar / doublewall, clear / doble pared / double paroi

	Ø cm	↑ cm
36062	13,5 / 10,5	23



### Flaschenkühler „CLASSIC“

bottle cooler  
enfriador de botella  
rafraîchisseur de bouteille



edler Kunststoffmantel in matt-metall Optik, Rand hochglanzpoliert, speziell isolierter Kunststoffeinsatz sorgt für beste Kühlung, für 0,5 - 1,5 Liter-Flaschen, Material: Mylar

noble plastic jacket in satin metal look, mirror polished finish edge, special insulated plastic insert, for 0,5 - 1,5 ltr. bottles, material: mylar

plástico imitación metal aspecto satinado, borde brillante, aislado interior especial para botellas de 0,5 a 1,5 ltr., material: mylar

plastique aspect métal satiné, bord brillant, paroi intérieure spécialement isolante pour bouteilles de 0,5 à 1,5 l., matière: mylar

	Ø cm	↑ cm
36036	12,5 / 10	22



### Flaschenkühler

bottle cooler  
enfriador de botella  
rafraîchisseur de bouteille



Rand matt poliert, doppelwandig für beste Isolierung, für 0,7 - 1,5 Liter Flaschen

satin polished finish edge, double wall cooler keeps the temperature for a long time, for 0,7 - 1,5 ltr. bottles

borde pulido satinado, con doble pared para mantener más tiempo la temperatura para botellas de 0,7 a 1,5 l.

bord métallique mat, double paroi pour excellente conservation de la température, pour bouteilles de 0,7 à 1,5 l.

	Ø cm	↑ cm
36050	11,5 / 9,5	23



**Flaschenkühler „ELEMENT BLACK“**

bottle cooler  
enfriador de botella  
rafraîchisseur de bouteille



**Beton, mit möbelschonender Unterseite**  
concrete, with non-scratching undersurface  
hormigón, con base anti rayaduras  
béton, avec base revêtement antirayures

	Ø cm	↑ cm
36099	12 / 10	19



**Flaschenkühler „ELEMENT“**

bottle cooler  
enfriador de botella  
rafraîchisseur de bouteille



**Beton, mit möbelschonender Unterseite**  
concrete, with non-scratching undersurface  
el hornigón, con base antirrayaduras  
le béton, avec base revêtue antirayures

	Ø cm	↑ cm
36090	12 / 10	19



**Kühlmanschette „WINE“**

cool collar  
funda enfriadora  
manchette rafraîchissante



**für Mineralwasser- und Weinflaschen, Aktivkühler, ohne Eis, nach 5 Minuten gekühlt, Aufbewahrung im Gefrierfach**  
for soda- and winebottles, active chiller without ice, chilled in 5 minutes, keep in the freezer  
para botellas de agua embotellada y vino, enfría sin hielo, en sólo 5 minutos, guardar en el congelador  
refroidit en 5 minutes, sans glace, conserver au congélateur, pour l'eau embouteillée et les bouteilles de vin

	cm	↑ cm	Farbe / Colour
36083	14 x 2	17,5	



**Kühlmanschette**

cool collar  
funda de frío  
housse isotherme



**für Sekt- / Champagnerflaschen, einfach im Gefrierfach einfrieren, komplette Flasche wird in 5 Min. auf angenehme Trinktemperatur gekühlt, außen reißfestes Stoffgewebe, innen Kunststoff mit Kühlgel gefüllt, unbegrenzt wiederverwendbar**  
for bottles of champagne, simply to freeze in the freezer, complete bottles will be cooled down in only 5 minutes, tearproof cloth outside, plastic filled with gel inside, unlimited reusable  
para botellas de cava o champán simplemente congelándola en el congelador, la botella entera se enfriará en 5 minutos, funda de plástico muy robusta, rellena con un gel congelante reutilizable ilimitadamente  
pour bouteilles de vin ou champagne, la housse est préalablement stockée au congélateur, où elle accumule le froid, ensuite elle refroidit une bouteille en quelques minutes, plastique résistant, contient un liquide congelant, à réutiliser de façon illimitée

	Ø cm	↑ cm
36075	11	18



**Pitcher**  
pitcher  
jarra  
pichet



	Ø cm	↑ cm	ltr.
93105	13	21	1,5



**Weinflaschenhalter**  
winebottle-stand  
soporte para botella de vino  
porte-bouteille



	cm	↑ cm
30333	22 x 6	20,5



**Flaschenträger**  
bottle rack  
porta botellas  
porte-bouteilles



für 6 Flaschen, Ring Ø 9,5 cm  
for 6 bottles, ring Ø 9,5 cm  
para 6 botellas, Ø 9,5 cm  
pour 6 bouteilles, Ø 9,5 cm

	cm	↑ cm
00630	32 x 21,5	32,5



**Bierglasträger**  
beer rack  
porta vasos de cerveza  
porte verres à bière



für Glasgrößen 0,2 - 0,3 Liter, für 10 Gläser, Ring Ø 6,5 cm  
for glasses size 0,2 - 0,3 liter, for 10 glasses, ring Ø 6,5 cm  
para vasos tamaño 0,2-0,3 l, para 10 vasos, Ø 9,5 cm  
pour verres de 0,2 à 0,3 l, pour 10 verres, Ø 9,5 cm

	cm	↑ cm
00632	40 x 16,5	29



**Gläserschiene**  
glass rack  
rack de copas  
rack porte-verres



aus 6 mm verchromten Draht, Wand- und Deckenmontage möglich, bietet Platz für 20 Gläser  
6 mm chrome plated wire, can be mounted under a shelf or on the wall, for 20 glasses  
alambre cromado de 6 mm, puede instalarse bajo una estantería o en la pared para 20 copas  
fil chromé de 6 mm, à installer sous une étagère ou contre un mur, pour 20 verres à pied

	cm	↑ cm
93400	45 x 32	6



Trinkbecher „CRYSTAL“

drinking cups  
vasos  
gobelets



Kristallglas-Optik, vielseitig einsetzbar, robustes, unzerbrechliches Material, ideal in sensiblen Bereichen wie Pool, Spa, Beach und Wellness einzusetzen, BPA-frei

crystal-glass-look, can be used in versatile ways, a solide and unbreakable material, ideal to be used at pool, spa, beach and wellness areas, bpa-free

look de vidrio, se pueden utilizar de muchas maneras diferentes, material sólido e irrompible, ideal para el uso en áreas como piscina, spa, playa y bienestar, libre de BPA

look de verre de cristal, peuvent être utilisés de différentes façons, matériau robuste et incassable, idéal pour une utilisation dans des zones comme la piscine, le spa, la plage et le bien-être, sans BPA

	Ø cm	↑ cm	ltr.	VE	Farbe / Colour
10500	7	9,5	0,15	48	—
10501	8	12,5	0,30	48	—
10502	9	15,5	0,50	48	—

	Ø cm	↑ cm	ltr.	VE	Farbe / Colour
10513	7	9,5	0,15	48	■
10514	8	12,5	0,30	48	■
10515	9	15,5	0,50	48	■



Trinkglas „BEACH“

drinking glass  
vaso  
verre



vielseitig einsetzbar, robustes, unzerbrechliches Material, ideal in sensiblen Bereichen wie Pool, Spa, Beach und Wellness einzusetzen, BPA-frei

can be used in versatile ways, a solide and unbreakable material, ideal to be used at pool, spa, beach and wellness areas, bpa-free

se pueden utilizar de muchas maneras diferentes, material sólido e irrompible, ideal para el uso en áreas como piscina, spa, playa y bienestar, libre de BPA

peuvent être utilisés de différentes façons, matériau robuste et incassable, idéal pour une utilisation dans des zones comme la piscine, le spa, la plage et le bien-être, sans BPA

	Ø cm	↑ cm	ltr.	VE
10505	8,5	13,5	0,30	48

# MOSCOW MULE



**Flaschenkühler „MOSCOW MULE“**  
 bottle cooler  
 enfriador de botellas  
 rafraîchisseur de bouteilles



**Edelstahl-Flaschenkühler, Antik-Kupfer-Look**  
 stainless steel cooler, copper antique look  
 enfriador de acero inoxidable, cobre estilo antiguo  
 rafraîchisseur en acier inox, cuivre style antique

	Ø cm	↑ cm	ltr.	Farbe / Colour	
93330	20	21	5		copper-antique-hammered



**Becher „MOSCOW MULE“, 2er-Set**  
 barrel copper mug, 2 pcs. set  
 taza, set de 2  
 gobelet, set de 2



**Edelstahlbecher, Antik-Kupfer-Look**  
 stainless steel cup, copper antique look  
 taza de acero inoxidable, cobre estilo antiguo  
 gobelet en acier inox, cuivre style antique

	Ø cm	↑ cm	ltr.	Farbe / Colour	
93367	9	10	0,5		copper-antique-hammered

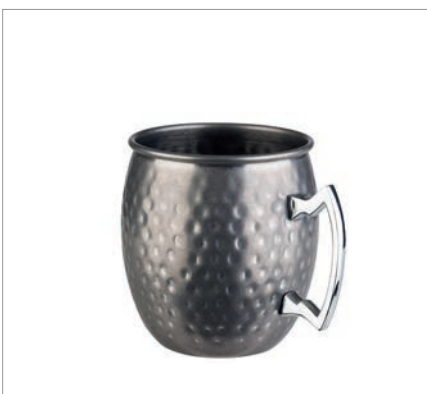

**Becher „MOSCOW MULE“**  
 barrel mug  
 taza  
 gobelet



**Edelstahlbecher, Antik-Edelstahl-Look**  
 stainless steel cup, stainless steel antique look  
 taza de acero inoxidable, acero estilo antiguo  
 gobelet en acier inox, acier style antique

	Ø cm	↑ cm	ltr.	Farbe / Colour	
93346	9	10	0,5		stainless-antique-hammered



**Becher „MOSCOW MULE“**

barrel mug  
taza  
gobelet



**Edelstahlbecher, Antik-Edelstahl-Look**  
stainless steel cup, stainless antique look  
taza de acero inoxidable, acero estilo antiguo  
gobelet en acier inox, acier style antique

	Ø cm	↑ cm	ltr.	Farbe / Colour	
93345	9	9	0,45		stainless-antique



**Becher „MOSCOW MULE“**

barrel copper mug  
taza  
gobelet



**Edelstahlbecher, Antik-Kupfer-Look**  
stainless steel cup, copper antique look  
taza de acero inoxidable, cobre estilo antiguo  
gobelet en acier inox, cuivre style antique

	Ø cm	↑ cm	ltr.	Farbe / Colour	
93322	9	9	0,45		copper-antique



**Becher „MOSCOW MULE“**

barrel copper mug  
taza  
gobelet



**Edelstahlbecher, Kupfer-Look, glänzend**  
stainless steel cup, copper look, highshine  
taza de acero inoxidable, cobre, brillante  
gobelet en acier inox, cuivre, brillant

	Ø cm	↑ cm	ltr.	Farbe / Colour	
93310	9	9	0,45		copper



**Becher „MOSCOW MULE“**

barrel copper mug  
taza  
gobelet



**Edelstahlbecher, Kupfer-Look, glänzend**  
stainless steel cup, copper look, highshine  
taza de acero inoxidable, cobre, brillante  
gobelet en acier inox, cuivre, brillant

	Ø cm	↑ cm	ltr.	Farbe / Colour	
93311	9	10	0,50		copper-hammered



**Becher „MOSCOW MULE“**

barrel copper mug  
taza  
gobelet



**Edelstahlbecher, Antik-Kupfer-Look**  
stainless steel cup, copper look  
taza de acero inoxidable, cobre estilo antiguo  
gobelet en acier inox, cuivre style antique

	Ø cm	↑ cm	ltr.	Farbe / Colour	
93323	9	10	0,50		copper-antique-hammered



**Becher „MOSCOW MULE“**

barrel mug  
taza  
gobelet



**Edelstahlbecher, Antik-Edelstahl-Look**  
stainless steel cup, stainless antique look  
taza de acero inoxidable, acero estilo antiguo  
gobelet en acier inox, acier style antique

	Ø cm	↑ cm	ltr.	Farbe / Colour	
93333	9,5	10	0,50		stainless-antique



**Becher „MOSCOW MULE“**

barrel copper mug  
taza  
gobelet



**Edelstahlbecher, Antik-Kupfer-Look**  
stainless steel cup, copper antique look  
taza de acero inoxidable, cobre estilo antiguo  
gobelet en acier inox, cuivre style antique

	Ø cm	↑ cm	ltr.	Farbe / Colour	
93331	9,5	10	0,50		copper-antique



**Becher „MOSCOW MULE“**

barrel copper mug  
taza  
gobelet



**Edelstahlbecher, Kupfer-Look, glänzend**  
stainless steel cup, copper look, glossy  
taza de acero inoxidable, cobre, brillante  
gobelet en acier inox, cuivre, brillant

	Ø cm	↑ cm	ltr.	Farbe / Colour	
93332	9,5	10	0,50		copper



**Becher „MINI SHOT“, 4er-Set**

barrel mug 4 pcs. set  
taza, set de 4  
gobelet, set de 4



	Ø cm	↑ cm	ltr.	Farbe / Colour	
93342	4,5	4,5	0,05		copper-antique
93343	4,5	4,5	0,05		copper
93344	4,5	4,5	0,05		stainless-antique



**Becher „COCKTAIL MUG“**

barrel  
taza  
gobelet



	Ø cm	↑ cm	ltr.	Farbe / Colour	
93370	8,5	14	0,5		stainless



**Becher „COOL“**

barrel mug  
taza  
gobelet



**Edelstahlbecher, Kupfer-Look, glänzend**  
stainless steel cup, copper look, glossy  
taza de acero inoxidable, estilo cobre, brillante  
gobelet en acier inox, aspect cuivre, brillant

	Ø cm	↑ cm	ltr.	Farbe / Colour	
93371	7,5	10,5	0,35		copper-look



**Becher „COOL“**

barrel mug  
taza  
gobelet



**Edelstahlbecher, Gunmetal-Look, glänzend**  
stainless steel cup, gunmetal look, glossy  
taza de acero inoxidable, estilo gunmetal, brillante  
gobelet en acier inox, aspect gunmetal, brillant

	Ø cm	↑ cm	ltr.	Farbe / Colour	
93372	7,5	10,5	0,35		gunmetal-look



**Becher „COOL“**

barrel mug  
taza  
gobelet



**Edelstahlbecher, Antik-Edelstahl-Look**  
stainless steel cup, stainless antique look  
taza de acero inoxidable, acero estilo antiguo  
gobelet en acier inox, acier style antique

	Ø cm	↑ cm	ltr.	Farbe / Colour	
93373	7,5	10,5	0,35		stainless-antique



**Becher „COOL“**

barrel mug  
taza  
gobelet



**Edelstahlbecher, Regenbogen-Look**  
stainless steel cup, rainbow look  
taza de acero inoxidable, estilo arco iris  
gobelet en acier inox, look arc-en-ciel

	Ø cm	↑ cm	ltr.	Farbe / Colour	
93374	7,5	10,5	0,35		rainbow-look



**Becher „BEER MUG“**

barrel mug  
taza  
gobelet



**Bierkrug, Antik-Look / beer mug, antique look / jarra de cerveza, estilo antiguo / chope, style antique**

	Ø cm	↑ cm	ltr.	Farbe / Colour	
93364	8,5	13	0,50		copper-antique
93365	8,5	13	0,50		stainless-antique





Becher „PINEAPPLE“

barrel mug  
taza  
gobelet



Glasbecher mit Edelstahl Deckel  
glass cup with stainless steel lid  
taza de cristal con tapa en acero inoxidable  
gobelet en verre avec couvercle en acier inox

	Ø cm	↑ cm	ltr.
93375	8,5	17,5	0,35



Becher „PINEAPPLE“

barrel mug  
taza  
gobelet



Edelstahlbecher, Kupfer-Look  
stainless steel cup, copper look  
taza de acero inoxidable, cobre  
gobelet en acier inox, cuivre

	Ø cm	↑ cm	ltr.	Farbe / Colour
93334	9	19	0,5	copper-look



Becher „PINEAPPLE“

barrel mug  
taza  
gobelet



Edelstahlbecher, Gold-Look  
stainless steel cup, gold look  
taza de acero inoxidable, dorada  
gobelet en acier inox, doré

	Ø cm	↑ cm	ltr.	Farbe / Colour
93335	9	19	0,5	gold-look



Becher „MINI SHOT“ 4er-Set



barrel mug, 4 pcs. set  
taza, set de 4  
gobelet, set de 4





	Ø cm	↑ cm	ltr.	Farbe / Colour
93339	4,5	5,5	0,06	copper-antique-hammered
93340	4,5	5,5	0,06	copper-hammered
93341	4,5	5,5	0,06	stainless-antique-hammered





**Becher „JULEP MUG“**  
barrel mug  
taza  
gobelet







	Ø cm	↑ cm	ltr.	Farbe / Colour
93336	8	11,5	0,40	 copper-antique-hammered
93337	8	11,5	0,40	 copper-hammered
93338	8	11,5	0,40	 stainless-antique-hammered



**Becher „JULEP MUG“**  
barrel mug  
taza  
gobelet

	Ø cm	↑ cm	ltr.	Farbe / Colour
93327	8,5	10	0,35	 copper-antique
93328	8,5	10	0,35	 copper
93329	8,5	10	0,35	 stainless



**Shaker „CLASSIC“**

shaker  
coctelera  
shaker



Edelstahlbecher, hochglanzpoliert  
stainless steel cup, mirror polished finish  
taza de acero, acabado pulido brillante  
gobelet en acier, brillant

	Ø cm	↑ cm	ltr.
36010	8,5	20	0,5
36011	9,0	23	0,7





**Shaker „CLASSIC“**

shaker  
coctelera  
shaker



Edelstahlbecher, Kupfer-Look, glänzend  
stainless steel cup, copper look, highshine  
taza de acero inoxidable, cobre, brillante  
gobelet en acier inox, cuivre, brillant

	Ø cm	↑ cm	ltr.	Farbe / Colour
93211	8,5	20	0,5	 copper
93212	9,0	23	0,7	 copper



**Shaker „CLASSIC“**

shaker  
coctelera  
shaker



Edelstahlbecher  
stainless steel cup  
taza de acero inoxidable  
gobelet en acier inox

	Ø cm	↑ cm	ltr.	Farbe / Colour
93366	9,0	23	0,7	 stainless-antique
93326	9,0	23	0,7	 copper-antique



**Parisian Shaker**

shaker  
coctelera  
shaker



Edelstahlbecher, mattiert  
stainless steel cup, satin polished finish  
taza de acero, acabado efecto satinado  
gobelet en acier, fini mat effet satin

	Ø cm	↑ cm	ltr.
93179	9,5	24	0,7



### Boston Shaker

boston shaker  
coctelera boston  
shaker boston



2-teilig: Becher, 700 ml + Glas, 400 ml

2 pcs. set: beaker, 700 ml + glass, 400 ml

set de 2 piezas: vaso coctelero, 700 ml+ vaso vidrio 400 ml

2 pièces: bol mélangeur, 700 ml + bol en verre 400 ml

	Ø cm	↑ cm	ltr.	Farbe / Colour	
93140	9	30	0,70 / 0,40		stainless-steel
93350	9	30	0,70 / 0,40		stainless-antique

	Ø cm	↑ cm	ltr.	Farbe / Colour	
93325	9	30	0,70 / 0,40		copper-antique
93201	9	30	0,70 / 0,40		copper

Ersatzglas / spare glass / vaso de recambio / verre de rechange

	Ø cm	↑ cm	ltr.
93138	8,5	14,5	0,4



### Boston Shaker

boston shaker  
coctelera boston  
shaker boston



2-teilig: Becher, 700 ml, gummiert, rutschfest + Glas, 400 ml

2 pcs. set: beaker, 700 ml, rubberized, anti-slip + glass, 400 ml

conjunto de 2 piezas: vaso coctelero con goma exterior 700 ml + vaso de vidrio 400 ml

2 pièces: bol mélangeur inox extérieur plastifié couleur 700 ml + bol en verre 400 ml

	Ø cm	↑ cm	ltr.	Farbe / Colour
93139	9	30	0,7	

Ersatzglas / spare glass / vaso de recambio / verre de rechange

	Ø cm	↑ cm	ltr.
93138	8,5	14,5	0,4



Barmaß  
jigger  
medidor jigger  
measure double jigger



	Ø cm	↑ cm	cl.	Farbe / Colour	
93351	4,5	9	2 / 4		stainless-steel-polished



Barmaß  
jigger  
medidor jigger  
measure double jigger



	Ø cm	↑ cm	cl.	Farbe / Colour	
93354	4,5	9	2 / 4		stainless-antique



Barmaß  
jigger  
medidor jigger  
measure double jigger



	Ø cm	↑ cm	cl.	Farbe / Colour	
93353	4,5	9	2 / 4		copper



Barmaß  
jigger  
medidor jigger  
measure double jigger



	Ø cm	↑ cm	cl.	Farbe / Colour	
93352	4,5	9	2 / 4		copper-antique

## Bar . Café . Drinkware



Barmaß  
jigger  
medidor  
measure double jigger



	∅ cm	↑ cm	cl.	Farbe / Colour	
93164	4,5	9	2,5 / 5		stainless-steel-polished



Barmaß  
jigger  
medidor jigger  
measure double jigger



	∅ cm	↑ cm	cl.	Farbe / Colour	
93355	4,0	11	1,5 / 2,5 / 3,5 / 5		stainless-antique



Barmaß  
jigger  
medidor jigger  
measure double jigger



	∅ cm	↑ cm	cl.	Farbe / Colour	
93324	4	11	2,5 / 5		copper-antique



Barmaß  
jigger  
medidor jigger  
measure double jigger



	∅ cm	↑ cm	cl.	Farbe / Colour	
93165	4	11	2,5 / 5		copper



**Barmaß**  
jigger  
medidor jigger  
measure double jigger



hochglanzpoliert, schnelles und genaues Abmessen von Spirituosen  
mirror polished finish, quick and exact measuring of spirits  
pulido brillante, medida rápida y exacta de licores  
poli miroir, mesure exact et rapide des spiritueux

	Ø cm	↑ cm	cl
93116	6 / 5	6	2 / 4



**Barmaß**  
jigger  
medidor jigger  
measure double jigger



	Ø cm	↑ cm	cl
93120	4,5 / 3,5	7,0	2 / 4



**Barmaß**  
jigger  
medidor jigger  
measure double jigger



	Ø cm	↑ cm	cl
93121	4,0 / 3,5	8,5	2 / 4
93112	4,5 / 4,0	8,5	2,5 / 5



**Barmaß**  
jigger  
medidor jigger  
measure double jigger



hochglanzpoliert, schnelles und genaues Abmessen von Spirituosen  
mirror polished finish, quick and exact measuring of spirits  
pulido brillante, medida rápida y exacta de licores  
poli miroir, mesure exact et rapide des spiritueux

	Ø cm	↑ cm	cl.
93357	3,5	7,5	3 / 5



**Barmaß**  
jigger  
medidor jigger  
measure double jigger



hochglanzpoliert, schnelles und genaues Abmessen von Spirituosen  
mirror polished finish, quick and exact measuring of spirits  
pulido brillante, medida rápida y exacta de licores  
poli miroir, mesure exact et rapide des spiritueux

	Ø cm	↑ cm	cl.
93356	5	9	1 / 1,5 / 2 / 3 / 4 / 6

## Bar . Café . Drinkware

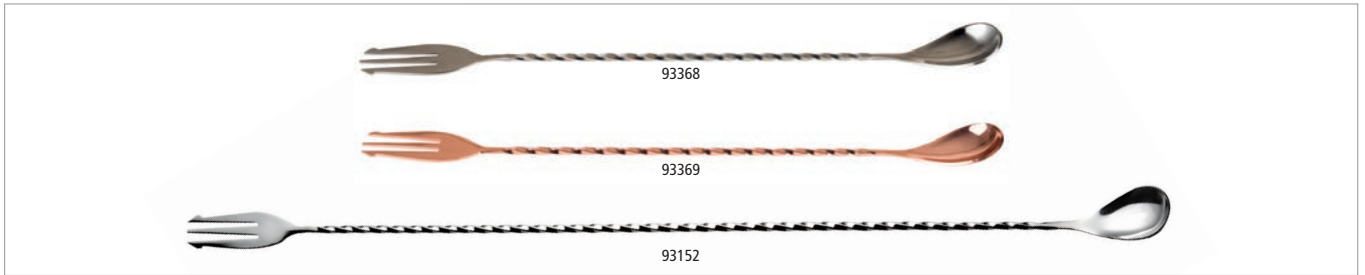

### Barlöffel / -gabel

bar spoon  
cucharilla de cóctel trident  
cuillère de bar trident

EDELSTAHL  
STAINLESS  
INOX

	→ cm	Farbe / Colour	
93368	30		stainless steel
93369	30		copper
93152	50		stainless steel

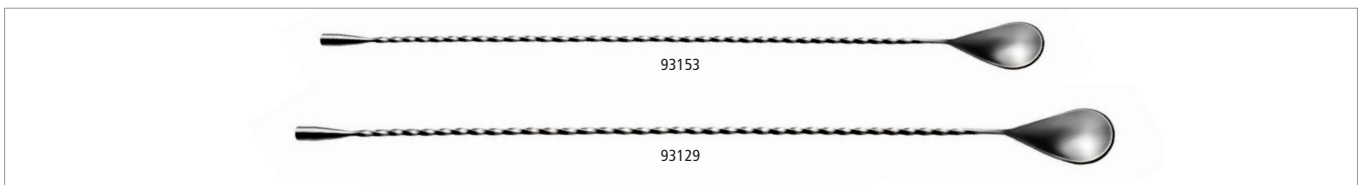

### Barlöffel

bar spoon  
cucharilla de cóctel  
cuillère à cocktail

EDELSTAHL  
STAINLESS  
INOX



	→ cm
93153	40
93129	44



### Barlöffel

bar spoon  
cucharilla de cóctel  
cuillère à cocktail

EDELSTAHL  
STAINLESS  
INOX



	→ cm
93134	27



### Barlöffel

bar spoon  
cucharilla de cóctel  
cuillère à cocktail

EDELSTAHL  
STAINLESS  
INOX



	→ cm	Farbe / Colour	
93034	27		copper



hot price



**Barsieb**  
bar strainer  
colador de cóctel  
tamis cocktail



hochglanzpoliert, Spiralfeder hält Eiswürfel beim Abseihen zurück, Feder kann zur Reinigung entnommen werden, passend für alle Gläser und Shaker  
mirror polished finish, coil spring keeps ice cubes in shaker, spring can be taken off for cleaning, suitable for all glasses and shakers  
con muelle para mantener los cubitos en la coctelera, el muelle se desmonta para limpiar, se adapta a todos los tipos de vasos y cocteleras  
brillant, avec ressort pour garder les glaçons dans le shaker, ressort démontable pour lavage, s'adapte à tous types de verres mélangeurs et shakers

	∅ cm	→ cm	→ ∅ cm
93300	8	Griff / handle 6	mit Auflage-Örchen 12



**Einhandgebrauch**  
handed use

**Julep Barsieb „PRO“**  
julep strainer  
colador de cóctel  
tamis cocktail



hochglanzpoliert  
mirror polished finish  
acabado pulido brillante  
fini poli brillant

	∅ cm	→ cm
93313	7,5	Griff / handle 9



93347



93348



93349



93312

**Barsieb**  
bar strainer  
colador de cóctel  
tamis cocktail



Spiralfeder hält Eiswürfel beim Abseihen zurück, Feder kann zur Reinigung entnommen werden, passend für alle Gläser und Shaker  
coil spring keeps ice cubes in shaker, spring can be taken off for cleaning, suitable for all glasses and shakers  
con muelle para mantener los cubitos en la coctelera, el muelle se desmonta para limpiar, se adapta a todos los tipos de vasos y cocteleras  
avec ressort pour garder les glaçons dans le shaker, ressort démontable pour lavage, s'adapte à tous types de verres mélangeurs et shakers

	∅ cm	→ cm	Farbe / Colour
93347	9	Griff / handle 9	copper-antique
93348	9	Griff / handle 9	copper
93349	9	Griff / handle 9	stainless-antique
93312	9	Griff / handle 9	stainless



**Einhandgebrauch**  
single-handed use



**Stößel**  
muddler  
mortero  
pilon muddler



**zum Auspressen von Früchten und Zerstoßen von Würfelzucker**

to press fruits or pound lump sugar  
para exprimir frutas y machacar azucarillos  
pour presser les fruits ou le sucre en morceaux

	Ø cm	→ cm
93188	4	28



**Stößel**  
muddler  
mortero  
pilon muddler



**mit griffigem Ende, zum Auspressen von Früchten und Zerstoßen von Würfelzucker**

with handy end, to press fruits or pound lump sugar  
acabado relieve para prensar frutas o azucar  
avec relief grillagé pour presser les fruits ou le sucre en morceaux

	Ø cm	→ cm	Farbe / Colour
93180	2,5	21	



**Stößel**  
muddler  
mortero  
pilon muddler



**mit griffigem Ende, zum Auspressen von Früchten und Zerstoßen von Würfelzucker**

with handy end, to press fruits or pound lump sugar  
con un acabado en relieve para exprimir frutas y machacar azucarillos  
avec relief grillagé pour presser les fruits ou le sucre en morceaux

	Ø cm	→ cm	Farbe / Colour
93358	3,5	20,5	stainless steel
93360	3,5	20,5	copper
93361	3,5	20,5	stainless-antique



**Stößel**  
muddler  
mortero  
pilon muddler



**grober Stößel, zum Auspressen von Früchten und Zerstoßen von Würfelzucker**

coarse notched, to press fruits or pound lump sugar  
mortero grueso con muescas para exprimir frutas y machacar azucarillos  
muddler grand format avec bout relief étoilé pour presser les fruits ou le sucre en morceaux

	Ø cm	→ cm	Farbe / Colour
93181	2,5	21	
93182	4	24	





**Barsieb**  
bar strainer  
colador de cóctel  
tamis cocktail



	Ø cm	→ cm
93318	8,5	11,5



**Schneidebrett „BAR“**  
cutting board  
table de corte  
planche à découper



**HDPE, mit Safrinne, mit Antirutsch-Füßchen**  
HDPE, with juice groove and non-slip feet  
HDPE, con ranura para líquidos y pies antideslizantes  
HDPE, avec rigole et pieds antidérapants

	cm	↑ cm
93306	30 x 20	2
93307	50 x 30	2



**Zitruspresse**  
citrus squeezer  
exprimidor cítricos  
presse-citron



**hochglanzpoliert, 2-teilig**  
mirror polished finish, 2 pcs.  
pulido brillante, 2 piezas  
brillant, 2 pièces

	Ø cm	↑ cm	ltr.
71431	12 / 17	10,5	0,35



**Cocktailmesser „ORANGE“**  
bar knife  
cuchillo para cóctel  
couteau cocktail



**mit 2 Zinken zum Aufspießen von Zitrusseiben**  
with 2 prongs to pick up slices of lemon  
con 2 dientes para pinchar las rodajas de limón, etc.  
avec 2 dents pour les rondelles de citron et autres décorations

	→ cm
88846	21



**Dekoriermesser „ORANGE“**  
decorating knife „canalé“  
cuchillo acanalador  
couteau cannelé



**gezahnte Klinge aus geschärftem Edelstahl**  
serrated sharpened blade, stainless steel  
hoja de sierra afilada, acero inoxidable  
lame inox microdentée

	→ cm
88843	19



2 Pressringe für Zitrone und Limette

**Limetten- / Zitronenpresse**  
lime- / lemonpress  
exprimidor de limón / lima  
presse citron



	cm	↑ cm
93214	21 x 7	5



**Limettenpresse**  
lime press  
prensa de limón  
presse citron



	cm	↑ cm
93189	21 x 7	5



Durch einfachen  
Druck leichte  
Teilung der  
Zitrus!

**Zitrussteiler**  
citrus wedge  
cortador de cítricos  
coupe-agrumes



mit Antirutsch-Füßchen, 2-teilig, Griffelement zur sicheren Bedienung mit innenliegendem Schneidmesser, teilt Zitrusfrüchte in Achtel, leicht unter fließendem Wasser zu reinigen

with non-slip feet, 2 pieces, handle for safe use and with internal cutting knife, cut citrus fruits in eight pieces, easy to clean with water  
con pies antideslizantes, 2 piezas, asas para un uso seguro y con cuchillas internas, divide los cítricos en ocho partes, fácil de limpiar con agua  
pieds antiglisses, 2 pièces, anses pour une usage sûr avec des lames internes, divise les agrumes en huit pièces, facile à nettoyer avec de l'eau

	cm	↑ cm
93317	20 x 15	19



**Eiseimer-Set mit Eiszange**

ice bucket set with tong  
cubitera clásica con pinza  
seau à glaçons classique avec pince



mit Abtropfgitter, isolierter Kunststoffeinsatz, Zange lässt sich im Deckel verstauen, für max. 50 Eiswürfel, hält die Eiswürfel bis zu 5 Stunden in ihrer Form

with drainer, insulated plastic insert, tongs can be stored in the lid, for max. 50 ice cubes, keeps the ice cubes in shape for up to 5 hours

con escurridor, inserto de plástico aislado, la pinza se puede guardar en la tapa, para un máximo de 50 cubitos de hielo, mantiene los cubitos de hielo en forma hasta 5 horas  
avec égouttoir, insert en plastique isolé, la pince peut être rangée dans le couvercle, pour max. 50 glaçons, maintient les glaçons dans leur forme jusqu'à 5 heures

	Ø cm	↑ cm	ltr.
36015	14	22	1,3



**Eiseimer-Set mit Eiszange**

ice bucket set with tong  
cubitera clásica con pinza  
seau à glaçons classique avec pince



für max. 45 Eiswürfel, hält die Eiswürfel bis zu 5 Stunden in ihrer Form

max. 45 ice cubes, keeps the ice cubes in shape for up to 5 hours

para un máximo de 45 cubitos de hielo, mantiene los cubitos de hielo en forma hasta 5 horas  
pour max. 45 glaçons, maintient les glaçons dans leur forme jusqu'à 5 heures

	Ø cm	↑ cm	ltr.
36013	12	14	1



**Eiseimer-Set mit Eiszange**

ice bucket set with tong  
cubitera clásica con pinza  
seau à glaçons classique avec pince



isolierter Kunststoffeinsatz, hält die Eiswürfel bis zu 5 Stunden in ihrer Form

insulated plastic insert, keeps the ice cubes in shape for up to 5 hours

inserto de plástico aislado, mantiene los cubitos de hielo en forma hasta 5 horas  
insert en plastique isolé, maintient les glaçons dans leur forme jusqu'à 5 heures

	Ø cm	↑ cm	ltr.
36027	15	15	1,5
36029	20	18	3



**Eiseimer-Set mit Eiszange**

ice bucket set with tong  
cubitera clásica con pinza  
seau à glaçons classique avec pince



edler Kunststoffmantel in matter Optik, Rand hochglanzpoliert, isolierter Kunststoffeinsatz, hält die Eiswürfel bis zu 5 Stunden in ihrer Form

noble plastic coat in satin metal look, with mirror polished edge, insulated plastic insert, keeps the ice cubes in shape for up to 5 hours

capa de plástico elegante con óptica de metal mate, borde pulido de alto brillo, inserto de plástico aislado, mantiene los cubitos de hielo en forma hasta 5 horas

manteau en plastique élégant en optique métal mat, bord poli brillant, insert en plastique isolé, maintient les glaçons dans leur forme jusqu'à 5 heures

	Ø cm	↑ cm	ltr.
36022	15	15	1,5
36024	20	18	3



**Kühlbox „FROSTY“**

bottle cooler  
enfriador de botellas  
rafraichisseur de bouteilles

**mit herausnehmbarem Einsatz für 4 Flaschen**

with removable insert for 4 bottles  
con inserto extraíble para 4 botellas  
avec insert amovible pour 4 bouteilles



**Abb. ohne Einsatz**  
illustration without insert

	cm	↑ cm	ltr.	Ø holes cm
93230	27 x 27	15	7,5	11



**Eisbox**

icebox  
cubitera  
seau à glaçons

**herausnehmbarer Innenbehälter dient als Tropfeinsatz, für max. 150 Eiswürfel, hält bis zu 5 Stunden die Eiswürfel in ihrer Form**

removable inner container serves as drainer, for max. 150 ice cubes, keeps the ice cubes in shape for up to 5 hours

contenedor interior extraíble sirve como inserto de goteo, para un máximo de 150 cubitos de hielo, mantiene los cubitos de hielo en forma hasta 5 horas

réceptier intérieur amovible sert d'égouttoir, pour max. 150 glaçons, maintient les glaçons dans leur forme jusqu'à 5 heures



	cm	↑ cm	ltr.	
93200	20 x 20	17	3,4	max. 150 ice cubes
93220	27 x 27	15	5	max. 300 ice cubes



**Eisbox**

icebox  
cubitera  
seau à glaçons

**herausnehmbarer Innenbehälter dient als Tropfeinsatz, für max. 150 Eiswürfel, hält die Eiswürfel bis zu 5 Stunden in ihrer Form**

removable inner container serves as drainer, for max. 150 ice cubes, keeps the ice cubes in shape for up to 5 hours

contenedor interior extraíble sirve como inserto de goteo, para un máximo de 150 cubitos de hielo, mantiene los cubitos de hielo en forma hasta 5 horas

réceptier intérieur amovible sert d'égouttoir, pour max. 150 glaçons, maintient les glaçons dans leur forme jusqu'à 5 heures



	Ø cm	↑ cm	ltr.	
36033	18,5	20	3	max. 150 ice cubes



**Eisbox**

icebox  
cubitera  
seau à glaçons

**herausnehmbarer Innenbehälter dient als Tropfeinsatz, für max. 300 Eiswürfel, hält bis zu 5 Stunden die Eiswürfel in ihrer Form**

removable inner container serves as drainer, for max. 300 ice cubes, keeps the ice cubes in shape for up to 5 hours

contenedor interior extraíble sirve como inserto de goteo, para un máximo de 300 cubitos de hielo, mantiene los cubitos de hielo en forma hasta 5 horas

réceptier intérieur amovible sert d'égouttoir, pour max. 300 glaçons, maintient les glaçons dans leur forme jusqu'à 5 heures



	Ø cm	↑ cm	ltr.	
36037	27	20	6	max. 300 ice cubes



**Eisschaufel**  
ice scoop  
pala de hielo  
pelle à glaçons



	cm	→ cm	ltr.
93192	10 x 6	29	0,7



**Eisschaufel**  
ice scoop  
pala de hielo  
pelle à glaçons



**gelocht, ideal zum Befüllen von schlanken Gläsern**  
perforated, ideal to fill narrow glasses  
perforada, ideal para llenar vasos estrechos  
perforée, idéale pour verser les glaçons dans des verres étroits

	Ø cm	→ cm
93191	5	19



**Glasumrander**  
glass rimmer  
ribeteador de vasos  
bordeur à verres „rimmer“



**Schwamm für Limettensaft, 2 Fächer für Zucker und Salz**  
with sponge for lime juice, 2 cases for sugar and salt  
con esponja para zumo de lima, 2 compartimentos para azucar y sal  
avec éponge et 2 compartiments pour sucre et sel

	cm	Farbe / Colour
93175	20 x 7,5	■



**Eis-Kugel-Former**  
ice ball former  
molde de cubitos de hielo esféricos  
moule à glaçons en boules



**2 tlg., 3 Kugeln à 100 ml, einfach mit Wasser füllen und gefrieren lassen**  
3 bowls à 100 ml, simply fill with water and allow to freeze  
3 bolas de 100 ml, simplemente llenar con agua y dejar congelar  
3 boules à 100 ml, simplement remplir avec de l'eau et mettre à congeler

	cm	↑ cm
12990	23,5 x 8,5	6,5



**Eiszerkleinerer**  
Ice crusher  
picadora de hielo  
broyeur à glaçons



**glasklar, mit Edelstahl-Messer**  
clear, stainless steel cutters  
cuchillas de acero inoxidable  
couteaux inox

	cm	↑ cm
36017	12 x 12	24



**Pinzettenzange**  
fine tong / tweezer  
pinza de emplatar  
pince à dresser

hochglanzpoliert, geriffelte Grifffläche, schwere Qualität  
mirror polished finish, ribbed handle, heavy gauge  
acabado brillante, mango cómodo ranurado, alta calidad  
brillant, manche rainuré antiglisse, qualité extra



→ cm

75820

16



**Pinzettenzange**  
fine tong / tweezer  
pinza de emplatar  
pince à dresser

hochglanzpoliert, geriffelte Grifffläche, schwere Qualität  
mirror polished finish, ribbed handle, heavy gauge  
acabado brillante, mango cómodo ranurado, alta calidad  
brillant, manche rainuré antiglisse, qualité extra



→ cm

75821

30



**Eiszange**  
ice cube tong  
pinza para cubitos de hielo  
pince à glaçons

hochglanzpoliert, fugenlos  
mirror polished finish, seamless  
pulido acabado brillante, de una sola pieza  
brillant, d'une seule pièce



cm

→ cm

75805

5 x 2

17,5



**Eiszange**  
ice tong  
pinza para cubitos de hielo  
pince à glaçons

matt poliert, mit griffigem Ende, ideal für Eiswürfel und Obstscheiben  
satin polished finish, with handy end, ideal for ice cubes and fruit slices  
pulido satinado, forma ergonómica ideal para cubitos de hielo y láminas de fruta  
poli mat satiné, forme ergonomique idéale pour glaçons et fruits tranchés



cm

→ cm

93190

2 x 1,5

20



**Reinigungsbürste für Ausgießer**  
pouwer cleaning brush  
cepillo de limpieza para picos vertedores  
brosse lave-bouchons doseurs



→ cm

93102

16,5



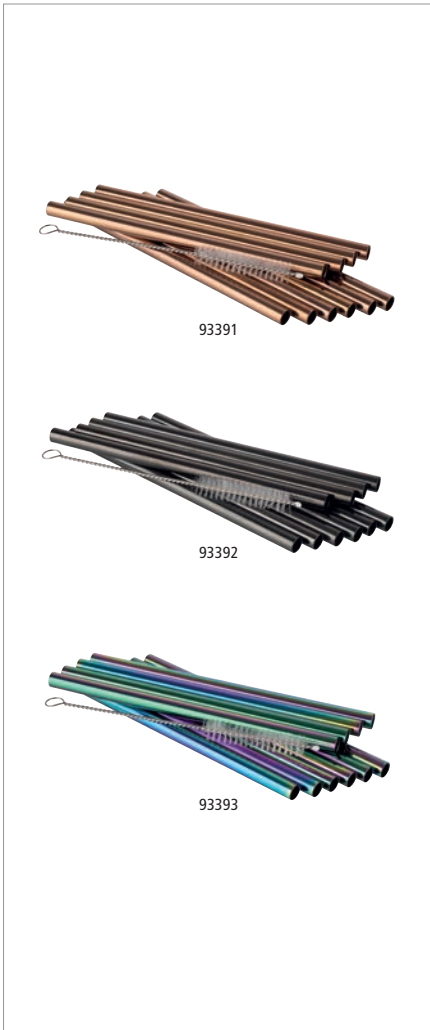

### Trinkhalme 11er Set

straws, 11 pcs. set  
pajas, set de 11 pz.  
pailles, set de 11 pc.



#### 11-teiliges Set: 10 Trinkhalme aus Edelstahl + Reinigungsbürste

11 pcs. set: 10 drinking straws made of stainless steel + cleaning brush  
set de 11: 10 pajas de acero inoxidable + cepillo de limpieza  
set de 11: 10 pailles en acier inox + brosse de nettoyage

	Ø mm	→ cm	Farbe / Colour	
93391 <small>NEW</small>	8	15,0		copper-look
93392 <small>NEW</small>	8	15,0		gunmetal-look
93393 <small>NEW</small>	8	15,0		rainbow-look
93380	6	21,5		copper-look
93381	6	21,5		gunmetal-look
93382	6	21,5		rainbow-look
93383	8	21,5		copper-look
93384	8	21,5		gunmetal-look
93385	8	21,5		rainbow-look

#### Ersatzbürste / replacement brush / cepillo de recambio / brosse de rechange

	Ø mm	→ cm
93395 <small>NEW</small>	8	15
93386	8	20



### Trinkhalme 7er Set

straws, 7 pcs. set  
pajas, set de 7 pz.  
pailles, set de 7 pc.



	Ø mm	→ cm	pcs.
93394 <small>NEW</small>	10	15	7
93390	10	21	7

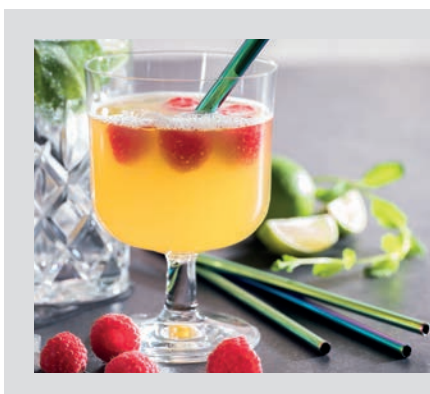



**Barmatte**  
drip mat  
tapete escurridor  
tapis de bar



aus weichem Kunststoff, zum Abtropfen von Gläsern etc.  
soft plastic, to store and drain glasses  
plástico blando para escurrir vasos  
plastique souple, pour l'égouttage des verres

	cm	↑ cm	Farbe / Colour	
93166	30 x 15	1	■	ohne Vertiefung
93167	45 x 31	1	■	ohne Vertiefung
93173	52 x 8	1	■	ohne Vertiefung
93168	60 x 8	1	■	mit Vertiefung
93169	60 x 8	1	■	ohne Vertiefung



**Abtropfmatte**  
drip mat  
esterilla escurridora  
tapis égouttoir



gerollt  
rolled  
enrollada  
roulée

	cm	↑ cm	Farbe / Colour
93314	60 x 300	0,3	■
93315	60 x 300	0,3	■

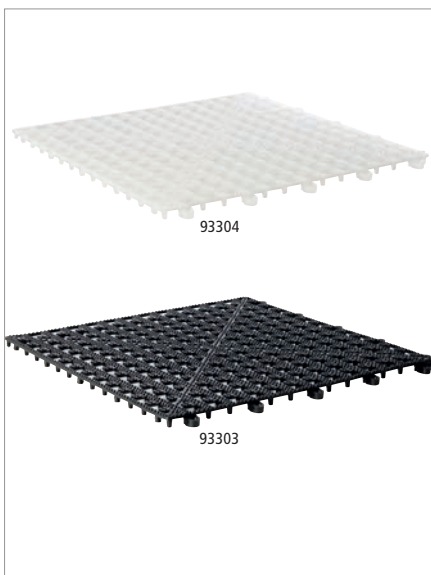

**Abtropfmatte**  
drip mat  
esterilla escurridora  
tapis égouttoir



erweiterbar durch Klick-Verbindung  
expandable  
las placas de fijan con clips  
avec clips de fixation

	cm	↑ cm	Farbe / Colour
93304	33 x 33	1,5	■
93303	33 x 33	1,5	■





**Zutatenbehälter**  
condiment holder  
dispensador de especias  
boîte à fruits et ingrédients



500 ml Inhalt pro Fach, 6 Fächer, inkl. Deckel (gefrostet) zur Lagerung  
6 chambers á 500 ml, incl. lid for storing  
6 compartimentos de 500 ml., incluye tapa para el almacenaje  
6 compartiments de 500 ml chacun, avec couvercle pour le stockage

	cm	↑ cm
93171	50 x 16	10



**Bar-Caddy**  
bar caddy  
organizador de bar  
organisateur „bar caddy“



Ordnungshilfe für Trinkhalme, Rührer, Servietten, Streichhölzer, etc.  
to organize straws, stirrers, napkins, matches, etc.  
para organizar pajitas, cucharillas, servilletas, cerillas, etc.  
pour bien organiser les pailles, agitateurs, cuillers, serviettes et autres accessoires

	cm	↑ cm
93174	24 x 15	11



7 ltr.

**Getränkspender „OLD FASHIONED“**  
beverage dispenser  
dispensador de bebidas  
distributeur de boissons



dicke, stabile Wände, weite Öffnung für große Zutaten, Gestell schwarz  
thick, stable walls, a wide opening for large ingredients, black stand  
tiene paredes gruesas y estables, amplia abertura para ingredientes grandes, soporte negro  
des murs épais et stables, large ouverture pour de grands ingrédients, support noir

	Ø cm	↑ cm	ltr.	
10409	24,5	50,5	7	inkl. Gestell / incl. stand



10,5 ltr.

**Getränkspender „FRUITS“**  
beverage dispenser  
dispensador de bebidas  
distributeur de boissons



dicke, stabile Wände, weite Öffnung für große Zutaten, Gestell schwarz  
thick, stable walls, a wide opening for large ingredients, black stand  
tiene paredes gruesas y estables, amplia abertura para ingredientes grandes, soporte negro  
des murs épais et stables, large ouverture pour de grands ingrédients, support noir

	Ø cm	↑ cm	ltr.	
10415	25	58	10,5	inkl. Gestell / incl. stand

# CONFERENCE



## Flaschenkühler „CONFERENCE“

conference bottle cooler  
enfriador múltiple  
rafraîchisseur

inkl. Kühlakku, Flaschenöffner, Kronkorkenschale,  
mit 6 Öffnungen Ø 6,7 cm für 0,25 - 0,5 Liter-Flaschen

incl. bottle cooler, bottle opener, small cap bowl,  
with 6 holes Ø 6,7 cm for 0,25 to 0,5 liter bottles

con acumulador de frío, abridor, recuperador de chapas,  
6 plazas Ø 6,7 cm, para botellas de 25 a 50 cl

avec accumulateur de froid, décapsuleur, bol récupérateur  
de capsules, 6 places Ø 6,7 cm, pour bouteilles de 25 à 50 cl



	Ø cm	↑ cm	Farbe / Colour
00620	23	15	White
00621	23	15	Black



## Kühlakku

cooler  
acumulador de frío  
accumulateur de froid

	Ø cm	→ cm	Farbe / Colour
00616	7,5	11,5	White
00615	7,5	11,5	Black



## Flaschenöffner

bottle opener  
abridor  
décapsuleur



	Ø cm	→ cm
00617	1	13,5



## Kronkorkenschale

cap bowl  
cuenco para chapas  
bol récupérateur de capsules



	Ø cm	↑ cm	Farbe / Colour
00618	6,5	3	White
00619	6,5	3	Black



**Spritzflasche inklusive Ausgießer**

squeeze bottle with nozzle  
botella exprimible con dosificador  
flacon pulvérisateur avec bec verseur



ideal für Bitter-Liköre, Essig, Öl

perfect for bitter liqueur, vinegar, oil  
perfecto para amargo licor, vinagre, aceite  
pour amaro liqueure, vinaigre, huile

	cm	↑ cm	ltr.
93308	6 x 5	20	0,2

**Ausgießer passend für Spritzflasche** / nozzle suitable for squeeze bottle / dosificador apto para botella exprimible / bec verseur approprié pour flacon pulvérisateur

	Ø cm	↑ cm
93309	2,5	5,5



**Rührglas mit Lippe**

mixing glass with lip  
vaso mezclador vertedor con pico  
verre mélangeur avec bec verseur



schwere Qualität

heavy quality  
alta calidad  
qualité renforcée

	Ø cm	↑ cm	ltr.	VE
93101	11,5	19	1	12



**Rührglas mit Lippe**

mixing glass with lip  
vaso mezclador vertedor con pico  
verre mélangeur avec bec verseur



	Ø cm	↑ cm	ltr.
93141	9	16	0,50



**Dosier- & Vorratsflasche**

pouring container  
botella „store & pour“  
bouteille „store & pour“



4-teilig: Behälter + Flaschenhals + Schraubdeckel + Ausgießer Ø 11 mm mit Luftzufuhr für gezieltes Ausgießen, zum Dosieren und Aufbewahren

4 pcs. set: for storage, mixing and serving drinks, nozzle Ø 11 mm  
set de 4 piezas: para almacenar y servir mezclas y bebidas, agujero de Ø 11 mm  
se compose de 4 pièces: idéal pour servir et pour conserver les boissons, embout Ø 11 mm

	Ø cm	↑ cm	ltr.	Farbe / Colour
93144	9	33	0,85	Yellow
93145	9	33	0,85	Red
93146	9	33	0,85	Green
93147	9	33	0,85	White
93148	9	33	0,85	Orange



abnehmbarer Boden dient als Deckel  
removable bottom serves as a lid



**Permanent-Ausgießer, 6er Set**  
 free flow pourer, 6 pcs. set  
 vertedor continuos set 6 piezas  
 set de 6 bouchons verseurs continus



à 2 Stück: blau, rot, gelb  
 2 pcs of each colour: blue, red, yellow  
 2 piezas de cada color: azul, rojo, amarillo  
 2 par couleur: bleu, rouge, jaune

	Ø cm	↑ cm	pcs.
93111	3	7,5	6



**Permanent-Ausgießer, 6er Set**  
 free flow pourer, 6 pcs. set  
 vertedor continuos set 6 piezas  
 set de 6 bouchons verseurs continus



	↑ cm	pcs.
93110	11	6



**Ausgießer, 2er Set**  
 pourers, 2 pcs. set  
 vertedores set 2 piezas  
 set de 2 bouchons verseurs



**Portionierer 2 cl, schnelles und genaues Abmessen**  
 2 cl, quick and exact measuring  
 2 cl. medición rápida exacta  
 2 cl mesure exacte et rapide

	↑ cm	pcs.
93115	10	2



**Permanent-Ausgießer, 6er Set**  
 free flow pourer, 6 pcs. set  
 vertedor continuos set 6 piezas  
 set de 6 bouchons verseurs continus



	↑ cm	pcs.
93114	8	6



**Sekt-Verschluss, 2er Set**  
 stopper, 2 pcs. set  
 set de 2 tapones  
 set de 2 bouchons



**matt poliert, innen Gummi Arabicum**  
 satin polished finish, inside rubber arabicum, with inscription  
 acabado pulido mate, interior goma arábica con inscripción  
 poli mat satiné, intérieur gomme arabique

	Ø cm	↑ cm	pcs.
93160	4	5,5	2



### Champagner- / Sektkonservator

champagne conservator  
tapón conservador  
bouchon de conservation



2-teilig: Überdruckpumpe + luftdichter Bügelverschluss mit Entlüftungsventil, Champagner und Sekt lassen sich nach dem Öffnen für längere Zeit frisch halten

2 pcs. set: overpressure pump + airtight swing-top with air valve, opened champagne and sparkling wine can be kept fresh for a longer time

set de 2 piezas: bomba a presión + tapón swing hermético con válvula de aire acero inox y plástico, el cava y las bebidas espumosas pueden conservarse y mantenerse por más tiempo.

set de 2 pièces: bombe à pression + bouchon swing hermétique avec valve - inox et plastique - enfin un moyen de conserver plus longtemps le champagne et autres vins mousseux

	Ø cm	↑ cm	Farbe / Colour
93126	4,5	12	■

Verschluss einzeln / stopper single / tapón individual / bouchon seul

93127



### Wein-Vakuum-Pumpe

vacuum wine pump  
bomba de vacío para vino  
pompe à vide pour le vin



inkl. 2 Stopfen, um offene Flaschen erneut zu versiegeln und den Wein zu konservieren

incl. 2 stoppers, to reseal open wine bottles and conserve the wine

incluye 2 tapones para cerrar perfectamente las botellas abiertas y conservar el vino

livrée avec 2 bouchons pour refermer les bouteilles tout en conservant le vin parfaitement

	Ø cm	↑ cm
93123	3,5	15

Weinpumpe-Ersatzstopfen, 2er Set / wine pump stopper, 2 pcs. set / tapones al vacío para el vino / set de 2 bouchons à vide pour le vin

	Ø cm	↑ cm	pcs.
93162	3	4,5	2

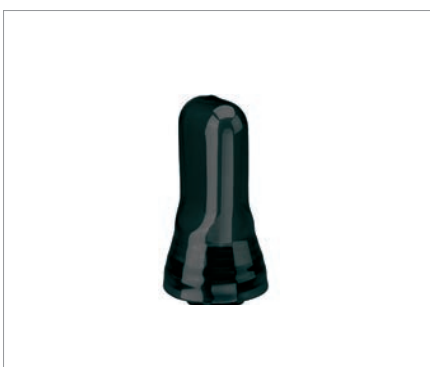

### Staubkappen, 2er Set

dust & fly cap, 2 pcs. set  
tapón antipolvo  
bouchon anti-poussières et anti-insectes



schützt vor Staub und Insekten

protects for dust and insects

para proteger de la suciedad e insectos

pour protéger de la poussière et des insectes

	Ø cm	↑ cm	pcs.	Farbe / Colour
93161	4	8	2	■

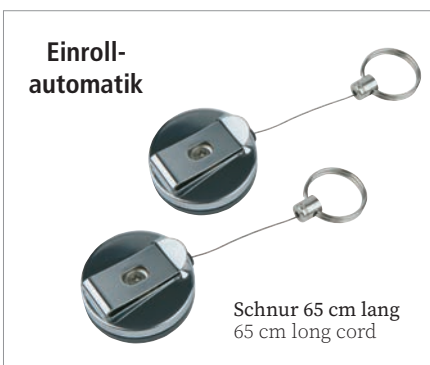

### Einroll-automatik

Schnur 65 cm lang  
65 cm long cord

### Schlüsselschnur, 2er Set

key cord, 2 pcs. set  
llavero enrollable  
porte-clés avec cable à enroulement



Befestigung mit Klammer am Gürtel, starke Rückzugfeder

to fix at waistbelt, strong pull-back spring

se fija en el cinturón, cable retrocede automáticamente

à fixer à la ceinture, enroulage automatique

	Ø cm	↑ cm
93170	4	2



**Kellnermesser „PROFI“**

waiter's corkscrew  
sacacorchos de camarero  
tire-bouchons



leichtgängige Teflon-Spirale, mehrstufige Klapphebelfunktion, am Fuß angebrachtes Messer  
easy moving teflon coil, 2-stage opening system, knife at the bottom end  
mecha de teflón, sistema de apertura en 2 golpes, con cuchillo en la parte superior  
mèche téflon, ouverture en 2 étapes, couteau dans la partie supérieure

→ cm

93302 11,5



**Kellnermesser**

waiter's corkscrew  
sacacorchos de camarero  
tire-bouchons



leichtgängige Teflon-Spirale, mehrstufige Klapphebelfunktion, am Kopf angebrachtes Messer  
easy moving teflon coil, 2-stage opening system, knife at the top end  
mecha de teflón, sistema de apertura en 2 golpes, con cuchilla en la parte superior  
mèche téflon, ouverture en 2 étapes, couteau dans la partie supérieure

→ cm

93301 12



**Kellner-Flaschenöffner**

waiter's barblade  
abridor camarero  
décapsuleur



**matt poliert**  
satin polished finish  
pulido acabado mate  
poli mat

cm

93122 18 x 4



mit Gummierung

**Kellner-Flaschenöffner**

waiter's barblade  
abridor camarero  
décapsuleur



**mit Gummierung**  
with rubber coating  
con revestimiento de goma  
avec revêtement en caoutchouc

cm

93125 11 x 4



**Kronkorkenöffner**

bottle cap opener  
abridor de chapas de pared  
décapsuleur mural



**für die Wandmontage, aus massivem Metall**  
for wall fastening, massive metal  
para fijación en la pared, metal macizo  
massif, à fixer au mur

cm

↑ cm

93124 7 x 8 3



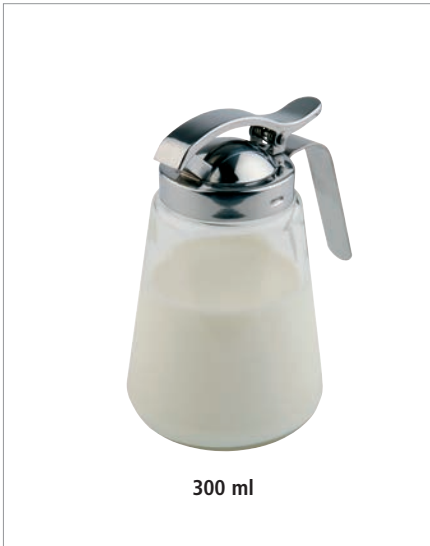

300 ml

**Allzweckgießer**

pourer  
bote vertedor universal  
pot verseur universel



für Honig, Kaffeesahne, etc., Schraubdeckel aus Edelstahl  
for honey, cream, etc., cover stainless steel  
para miel, crema, etc., tapa inoxidable  
pour le miel, le lait, la crème, etc., couvercle inox

	Ø cm	↑ cm	ltr.
00765	8,5	13,5	0,3

Ersatzglasbehälter / spare glass-container / contenedor de repuesto / récipient verre de rechange

00768



300 ml

**Zuckerdosierer**

sugar dispenser  
azucarero  
sucrier



Schraubdeckel aus Edelstahl  
cover stainless steel  
tapa inoxidable  
couvercle inox

	Ø cm	↑ cm	ltr.
00766	8,5	15	0,3

Ersatzglasbehälter / spare glass-container / contenedor de repuesto / récipient verre de rechange

00768



40490  
150 ml

40494  
250 ml

**Zuckerdosierer**

sugar dispenser  
azucarero  
sucrier



Schraubdeckel aus Edelstahl, mit Dosierrohr  
cover stainless steel with dosingtube  
tapa inoxidable y tubo dosificador  
couvercle inox et tube doseur

	Ø cm	↑ cm	ltr.
40490	8,5	12	0,15
40494	8,0	15	0,25

Ersatzglasbehälter / spare glass-container / contenedor de repuesto / récipient verre de rechange

	fits to
40498	40490
40499	40494



**Zuckerdosierer**

sugar dispenser  
azucarero  
sucrier



**Schraubdeckel aus Edelstahl, mit Dosierrohr**  
cover stainless steel, with dosing tube  
tapa inoxidable y tubo, con cierre dosificador  
couvercle inox et tube doseur

	Ø cm	↑ cm	litr.
40509	6	14,5	0,2



**Allzweckgießer**

pourer  
dosificador  
doseur



**Schraubdeckel aus Edelstahl und Kunststoff, mit Dosierklappe**  
cover stainless steel and plastic, with dosing flap  
acero inoxidable y tapa plástico, con cierre dosificador  
couvercle en inox et plastique, avec couvercle doseur

	Ø cm	↑ cm	litr.
40488	8	12,5	0,25



**Zuckerdosierer**

sugar dispenser  
azucarero  
sucrier



**Schraubdeckel aus Edelstahl, mit Dosierrohr**  
cover stainless steel, with dosing tube  
tapa inoxidable y tubo, con cierre dosificador  
couvercle inox et tube doseur

	Ø cm	↑ cm	litr.
40486	8	15	0,25



**Zuckerdosierer**

sugar dispenser  
azucarero  
sucrier



**Schraubdeckel aus Edelstahl, mit Dosier-Rohr**  
cover stainless steel, with dosing tube  
tapa inoxidable y tubo dosificador  
couvercle inoxydable et tube doseur

	Ø cm	↑ cm	litr.
40506	7,5	17,0	0,32



**Zuckerdosierer**

sugar dispenser  
azucarero  
sucrier



**Schraubdeckel mit Klappe aus Edelstahl, mit Dosierklappe**  
cover stainless steel, with dosing flap  
tapa acero inoxidable, con cierre dosificador  
couvercle inox, avec couvercle doseur

	Ø cm	↑ cm	litr.
40487	7,5	13,5	0,32



### Zuckerdosierer „OLD FASHIONED“

sugar dispenser  
azucarero  
sucrier



Schraubdeckel mit Klappe aus Edelstahl, mit Dosierklappe  
cover stainless steel, with dosing flap  
tapa acero inoxidable, con cierre dosificador  
couvreclé inox, avec couvercle doseuse

	Ø cm	↑ cm	ltr.
40510	7,5	14	0,35



### Zuckerdosierer

sugar dispenser  
azucarero  
sucrier



mit Schraubverschluss, Dosier-Rohr Ø 15 mm  
cover and dosingtube Ø 15 mm  
con tapa y tubo dosificador Ø 15 mm  
couvreclé avec tube doseur Ø 15 mm

	Ø cm	↑ cm	ltr.
40508	6,5	14,5	0,20



### Zuckerspender / Milchkännchen

sugar pourer / milk jug  
dispensador de azúcar  
sucrier doseur



matt poliert  
satin polished finish  
pulido efecto satinado  
intérieur et extérieur poli mat

	Ø cm	↑ cm	ltr.
10316	5	15	0,17



### Teekanne „ASIA“

teapot  
tetera  
théière



aus Gusseisen, innen emailliert, hält den Tee lange warm,  
kein nachbittern, ideal für zwei Tassen

made of cast iron, keeps the tea warm for  
a long time, no bitterness, ideal for two cups

hecho de hierro fundido, mantiene el té caliente durante  
mucho tiempo, sin amargar, ideal para dos tazas

en fonte, maintient le thé chaud pendant longtemps,  
pas d'amertume, idéal pour deux tasses

	Ø cm	↑ cm	ltr.
10990	12,5 x 11	12,5	0,3



mit abnehmbarem Deckel  
with removable lid



**Milch-/Universalkanne „ANTIHAFT“**

non stick jug  
jarra antiadherente  
pichet antiadhésif



**PTFE-antihaftbeschichtet, perfekt für die Herstellung von Milchschaum**

PTFE coated, for baristas frothing hot milk  
revestimiento PTFE, ideal para espume de leche  
revêtement PTFE, idéal pour faire mousser le lait

	Ø cm	↑ cm	ltr.
10334	8,0	10,0	0,35
10335	9,0	11,5	0,6
10336	10,5	13,0	0,8



**Milch- / Universalkanne**

milk / water jug  
jarra leche / agua  
pichet à eau / lait



**außen hochglanzpoliert, innen matt poliert**

outside mirror polished finish, inside satin polished finish  
exterior brillante, interior satinado  
extérieur brillant, intérieur mat satiné

	Ø cm	↑ cm	ltr.
10328	8,0	10,0	0,35
10329	9,0	11,5	0,6
10330	10,5	13,0	0,8
10331	12,0	16,5	1,3
10332	13,5	18,0	2,0



**Kaffeekanne**

coffee pot  
cafetera  
pichet à café



**hochglanzpoliert, mit Klappdeckel**

mirror polished finish, with hinged cover  
acabado brillante, tapa con bisagra  
poli brillant, couvercle à charnière

	Ø cm	↑ cm	ltr.
10323	8,0	11,5	0,35
10322	9,0	14,0	0,6
10325	10,5	15,5	0,9
10326	12,0	18,5	1,5
10327	13,5	20,0	2,0



**Milchkännchen / Sahnegießer**

milk / cream jug  
jarra de leche/ crema  
pichet à eau ou lait



	Ø cm	↑ cm	ltr.
10318	4	4	0,05
10319	5	5	0,09
10320	6	6	0,15



### Milchkännchen, 4er Set

milk/cream jugs, 4 pcs. set  
pack de 4 jarritas para leche o crema  
pack de 4 crémiers



hochglanzpoliert, für Kaffeesahne, mit Griff, Inhalt à 25 ml  
mirror polished finish, for coffee-cream, with handle, capacity à 25 ml  
pulido brillante, para crema de café, con asa, capacidad 25 ml  
brillant, avec anse, 25 ml

	Ø cm	↑ cm	pcs.	ltr.
10321	3,5	3,5	4	0,025



### Milch- und Zucker-Set

milk and sugar set  
set de leche y azúcar  
set sucrier et crémier



Set bestehend aus: Tablett 21 x 14 cm, H: 1,5 cm; Zuckerdose Ø 8cm, H: 7 cm;  
Milchkännchen Ø 6 cm, H: 8 cm, 0,2 Liter, Löffel

set consisting of: tray 21 x 14 cm, h: 1,5 cm; sugar bowl Ø 8cm, h: 7 cm;  
milk jug Ø 6 cm, h: 8 cm, 0,2 ltr., spoon

set compuesto por: bandeja 21 x 14 cm, a: 1,5 cm; azucarero Ø 8cm, a: 7 cm;  
jara de leche Ø 6 cm, a: 8 cm, 0,2 L., cuchara

ensemble composé de: plateau 21 x 14 cm, h: 1,5 cm; sucrier Ø 8cm, h: 7 cm;  
crémier Ø 6 cm, h: 8 cm, 0,2 l, cuillère

	cm	↑ cm
00638	21 x 14	7

Ersatzlöffel / replacement spoon / cuchara de recambio / cuillère de rechange

	→ cm
00639	12

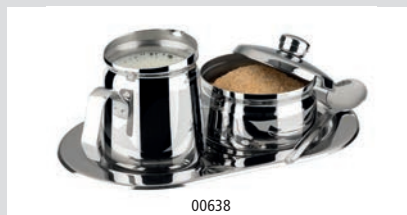

00638



00639



### Zuckertüten-Box

sugar pocket holder  
azucarero para bolsitas  
porte-sachetsw de sucre



matt poliert, für ca. 15 Zuckertüten  
satin polished finish, for ca. 15 sugar packets  
acabado pulido efecto satinado, capacidad 15 sobrecillos  
poli mat, pour 15 sachets

	cm	↑ cm
11579	9 x 7,5	5



**Zuckerkugel**

sugar pot  
azucarero  
sucrier



**hochglanzpoliert, mit Rolldecke**  
mirror polished finish, rolltop cover  
pulido acabado brillante, tapa abatible  
brillant, couvercle abattant

	∅ cm	↑ cm
00033	13,5	15



**Teebrühsieb**

snap mesh tea ball  
infusor de té, pinza con malla  
boule à thé avec pince



**matt poliert, mit feinem Sieb, aufklappbar**  
satin polished finish, with fine mesh, hinged  
acabado pulido efecto satinado, con malla fina, con bisagra  
inox mat, maille fine, avec charnière

	∅ cm	→ cm
74750	4,5	15,5



**Zitronenschnitzelpresse**

lemon slice squeezer  
pinza exprimelimon  
pince presse citron



**hochglanzpoliert, zum Auspressen von Zitronenscheiben**  
mirror polished finish, to press lemon slices  
pulido brillante, para rodajas de limón  
brillant, pour citrons en rondelle

	cm
71430	8 x 7



**Schale, 2-geteilt**

bowl, 2-section  
cuenco, 2 secciones  
bol 2 compartiments



	cm	↑ cm
83538	17,5 x 7,5	4,5



**Flambierbrenner**

chefs blow torch  
soplete de cocina para flambeare  
chalumeau de cuisine



**mit handelsüblichem Feuerzeuggas auffüllbar, Flamme einstellbar bis ca. 1300° C, Brenndauer von min. 60 Minuten**

to be filled with commercial lighter gas, flame adjustable up to approx. 1300° C, burning time of at least 60 minutes  
rellenable con gas de mechero comercial, llama ajustable hasta 1300° C, tiempo de combustión de al menos 60 minutos  
rempli avec gaz pour briquet commercial, flamme réglable jusqu'à 1300° C, temps de combustion d'au moins 60 minutes

	∅ cm	↑ cm
77315	4,5	16,5

NEW



30130



30131



30132



30132



30133



30133

Tablett „VINTAGE“

tray  
bandeja  
plateau



Edelstahl-Look vintage  
stainless steel vintage look  
acero inoxidable look vintage  
acier inox look vintage

	cm	↑ cm
30130	26,0 x 13,5	1,5
30131	34,0 x 18,0	1,5
30132	38,0 x 26,5	1,5
30133	25,5 x 16,0	3,0

passende Schälchen / fitting bowls / cuencos adecuados / bols apropiés



	Ø cm	↑ cm	ltr.
40655	7,5	5,5	0,17
40656	7,5	10	0,35



S. 276  
page 276



30130



30132

Servierbeispiel  
presentation example

NEW



40680



40681

Servierkelle „BOB“

serving trowel  
paleta para servir  
truelle de service



Edelstahl Servierkelle mit schwarzem Holzgriff  
stainless steel serving trowel with black wooden handl  
paleta para servir de acero inoxidable con mango de madera negra  
truelle de service en acier inox avec manche en bois noir

	cm	↑ cm	Griff	
40680	23,5 x 15,5	12,5	13,5	stainless steel
40681	23,5 x 15,5	12,5	13,5	—



hot price

Serviertablett „KAFFEEHAUS“

tray  
bandeja  
plateau



Innenfläche ziseliert, Rand eingerollt  
rolled edge  
borde redondeado, superficie decor relieve  
bord rond, surface entièrement ciselée

	cm	pcs.
30114	30 x 22	48



84251

Serviertablett „KAFFEEHAUS“

tray  
bandeja  
plateau



	cm	↑ cm	Farbe / Colour
84251	26,0 x 20,0	1,5	■
84253	28,5 x 21,5	1,5	■



Serviertablett „KAFFEEHAUS“

tray  
bandeja  
plateau



matt poliert, Rand eingerollt  
satin polished finish, rolled edge  
acabado pulido efecto satinado, borde redondeado  
effet satin, bord rond

	cm	↑ cm
30118	21,5 x 13	1,5



Serviertablett „KAFFEEHAUS“

tray  
bandeja  
plateau



matt poliert, Rand eingerollt  
satin polished finish, rolled edge  
acabado pulido satinado, borde redondeado  
effet satin mat, bord rond

	cm	↑ cm
30119	23 x 23	1,5



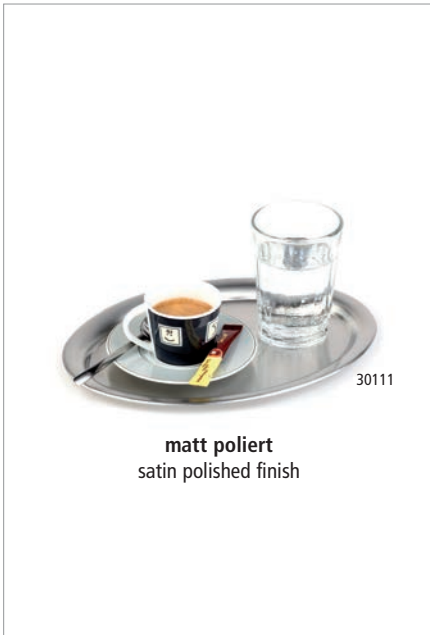

**Serviertablett „KAFFEEHAUS“**

tray  
bandeja  
plateau



**matt poliert, oval, Rand eingerollt**  
satin polished finish, oval, rolled edge  
pulido acabado efecto satinado, oval, borde redondeado  
effet satin, ovale, bord rond

	cm	↑ cm	
30111	19,0 x 15,0	1	für Zucker und Sahne / for sugar and cream para azúcar y crema / pour le sucre et la crème
30112	26,5 x 19,0	1	für eine Tasse / for one cup para una taza / pour une tasse
30113	29,0 x 22,0	1	für zwei Tassen / for two cups para dos tazas / pour deux tasses
30123	23,0 x 17,5	1	Eisdielen-Größe / icecream pralor size tamaño especial para heladerías / taille spéciale pour glaciers



**Serviertablett „KAFFEEHAUS“**

tray  
bandeja  
plateau



**hochglanzpoliert, oval, Rand eingerollt**  
mirror polished finish, oval, rolled edge  
pulido efecto espejo, ovalado, borde redondeado  
effet brillant, ovale, bord rond

	cm	↑ cm	
30115	19,0 x 15,0	1	für Zucker und Sahne / for sugar and cream para azúcar y crema / pour le sucre et la crème
30116	26,5 x 19,0	1	für eine Tasse / for one cup para una taza / pour une tasse
30117	29,0 x 22,0	1	für zwei Tassen / for two cups para dos tazas / pour deux tasses

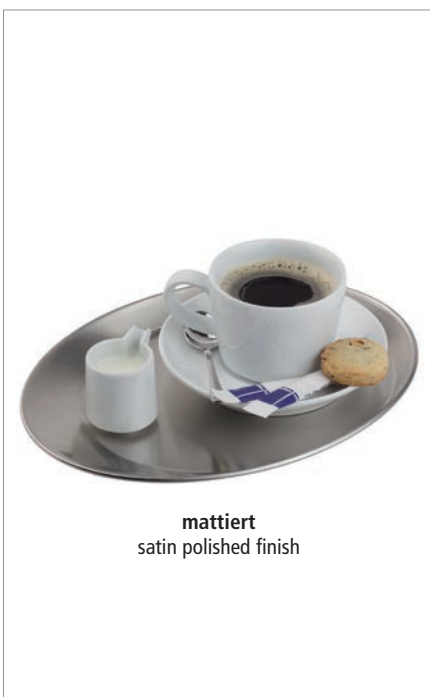

**Serviertablett „KAFFEEHAUS“**

tray  
bandeja  
plateau



	cm	↑ cm	
30126	25,5 x 19,5	2	mattiert / satin polished finish acabado efecto satinado / fini mat effet satin



Serviertablett „HAPPY HOUR“

tray  
bandeja  
plateau



rutschfeste Oberfläche  
non-slip surface  
superficie anti-deslizante  
surface antidérapante

	Ø cm	↑ cm	Farbe / Colour
00510	32	1,5	■
00511	38	1,5	■
00515	43	1,5	■



00548

Tablett „GASTRO“

tray  
bandeja  
plateau



rutschfeste Oberfläche  
non-slip surface  
superficie anti-deslizante  
surface antidérapante

	Ø cm	↑ cm	Farbe / Colour
00547	27,5	2	■
00548	35,5	2	■
00549	40,5	2	■



Tablett „BISTRO“

tray  
bandeja  
plateau



rutschfest, mit 2 Griffmulden und Stapelrand  
non-slip, two open handles, stackable edge  
anti-deslizante, 2 asas  
antidérapant, 2 anses

	Ø cm	↑ cm	Farbe / Colour
84045	35,5	4,5	■



00500

00507

Bierglasträger „NON-SLIP“

beer rack  
bandeja para cerveza  
porte verre à bière



rutschfeste Oberfläche  
non-slip surface  
superficie anti-deslizante  
surface antidérapante

	Ø cm	↑ cm	Farbe / Colour
00500	36	3,5	■
00501	36	3,5	■

	cm	↑ cm	Farbe / Colour
00506	28 x 20	1,5	■
00507	28 x 20	1,5	■

NEW



mit Absatz Ø 5 cm  
with hole Ø 5 cm

**Servierbrett, 2-tlg.**

serving board, 2 pcs. set  
tabla de servir, set de 2  
planche de service, set de 2

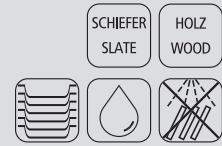

2-teilig:

1 Holzbrett aus Akazienholz + 1 Naturschieferplatte  
1 wood board made of acacia wood + 1 natural slate tray  
1 tabla de madera de acacia + 1 pizarra natural  
1 planche en bois d'acacia + 1 ardoise naturelle

	cm	↑ cm
00814	28 x 17,5	2,0

NEW



00897



00898



00899

**Servierbrett**

serving board  
tabla de servir  
planche de service



Servierbrett aus geöltem Akazienholz

serving board made of oiled acacia wood  
tabla de servir de madera de acacia aceitada  
planche en bois avec plateau en bois d'acacia huilé

	cm	↑ cm
00897	30 x 15	2,0
00898	30 x 18	2,0
00899	35 x 25	2,0

**Serviertablett „NON-SLIP“**

tray non-slip  
bandeja antideslizante  
plateau antiglisse

rutschfeste Oberfläche

non-slip surface  
superficie antideslizante  
surface antidérapante



00502

	cm	↑ cm	GN
00502	53 x 32,5	1,5	1/1
00508	46 x 36,0	2	
00505	53 x 32,5	1,5	1/1
00503	53 x 37,0	1,5	

**Tablett**

tray  
bandeja  
plateau



rutschfest, Holzdekor-Laminat

non-slip, coated wood  
antideslizante  
antidérapant



00526

	cm	↑ cm
00524	43,5 x 31,5	1,5
00525	52,0 x 39,0	1,5
00526	60,5 x 42,5	1,5



**Fast Food-Tablett**

snack tray  
bandeja autoservicio y snacks  
plateau self-service et snacks



	cm	↑ cm	GN	Farbe / Colour
00530	35 x 27,0	2		
00535	41 x 30,5	2		
00540	45 x 35,5	2		
00552	53 x 32,5	2	1/1	
	cm	↑ cm	GN	Farbe / Colour
00531	35 x 27,0	2		
00536	41 x 30,5	2		
00541	45 x 35,5	2		
00553	53 x 32,5	2	1/1	
	cm	↑ cm	GN	Farbe / Colour
00532	35 x 27,0	2		
00537	41 x 30,5	2		
00542	45 x 35,5	2		
00554	53 x 32,5	2	1/1	
	cm	↑ cm	GN	Farbe / Colour
00533	35 x 27,0	2		
00538	41 x 30,5	2		
00543	45 x 35,5	2		
00555	53 x 32,5	2	1/1	



**Tablett**

tray  
bandeja  
plateau



**rutschfest, Mahagonifurnier**  
non-slip, woodform, mahogany  
antideslizante  
antidérapant

	Ø cm	↑ cm
00528	31,0	3,5
00529	35,5	3,5



rutschfest / non-slip



00522

**Tablett**

tray  
bandeja  
plateau



**rutschfest, Holzdekor-Laminat**  
non-slip, coated wood  
antideslizante  
antidérapant

	cm	↑ cm
00521	26 x 20	1
00522	29 x 21	1



**Rechnungstablett**

bill presenter  
porta cuenta  
porte-addition



mit Klemme für Rechnung  
with clip for bill  
con clip para la nota  
avec clip pour la note

	cm	↑ cm
30108	20 x 12	0,5



**Rechnungstablett**

bill presenter  
porta cuenta  
porte-addition



mit Klemme für Rechnung  
with clip for bill  
con clip para la nota  
avec clip pour la note

	cm	↑ cm
30110	17 x 11	1



**Rechnungstablett, 2er Set**

bill presenter, 2 pcs. set  
porta cuenta, set de 2  
porte-addition, set de 2



1 Edelstahl-Tablett hochglanzpoliert + 1 klappbare Ledermappe  
mit Stiftflasche, mit Magnethalterung

1 stainless tray mirror polished finish + 1 leather presenter, with magnetic system

1 bandeja de acero inoxidable pulido brillante + 1 presentador de cuero con sistema magnético

1 plateau inox poli brillant + 1 pochette cuir aimantée

	cm	↑ cm
30109	20 x 16	2



**Tischkrümelentferner**

crumber  
recogemigas  
ramasse-miettes



matt poliert

satin polished finish

acabado mate, fácil de usar, mango hueco

mat satiné, manche creux, simple à utiliser

	Ø cm	↑ cm	
00058	6,5 x 2,5	22	Hohlgriff / hollow handles
00581	19,5 x 4,5	1	geschliffene Edelstahlkante flat grinded stainless steel edge



Windaschenbecher „DIAMOND“

ashtray  
cenicero  
cendrier



Metall verchromt, mit Bajonettverschluss  
metal chrome plated, bayonet lock  
metal cromado, cierre de bayoneta  
metal chrome, verrouillage par baïonnette

	Ø cm	↑ cm	Farbe / Colour	
00565	12	8,0		Glas gefrostet / glass frosted
00566	12	8,0		Glas glänzend / glass shiny
00567	12	8,0		Glas glänzend / glass shiny



Windaschenbecher

ashtray  
cenicero  
cendrier



Metall verchromt, Glas gefrostet, mit Bajonettverschluss  
metal chrome plated, glass frosted, bayonet lock  
metal cromado, opaco mate, cierre de bayoneta  
métal chromé, mat, verrouillage par baïonnette

	Ø cm	↑ cm	Farbe / Colour	
00560	9,5	8		
00561	9,5	8		
00562	9,5	8		
00563	9,5	8		
00564	9,5	8		





### Drehaschenbecher „PUSH“

ashtray  
cenicero  
cendrier



Deckel mit Drehmechanismus, mit Bajonettverschluss  
with rotary button, bayonet lock  
con botón giratorio, cierre de bayoneta  
tourne par pression sur le bouton, verrouillage par baïonnette



Drehmechanismus  
rotary button

	Ø cm	↑ cm
00568	9,5	11



### Windaschenbecher

ashtray  
cenicero  
cendrier



Metall verchromt, Glas gefrostet, mit Bajonettverschluss  
metal chrome plated, glass frosted, bayonet lock  
metal cromado, opaco mate, cierre de bayoneta  
métal chromé, mat, verrouillage par baïonnette

	Ø cm	↑ cm	Farbe / Colour
00582	9,5	8	Black
00583	9,5	8	Orange
00584	9,5	8	Teal
00585	9,5	8	White



### Drehaschenbecher „KLASSIKER“

ashtray  
cenicero  
cendrier giratoire



Deckel mit Drehmechanismus  
with rotary button  
con botón giratorio  
tourne par pression sur le bouton



Drehmechanismus  
rotary button

	Ø cm	↑ cm	Farbe / Colour
00054	13,0	10,5	Black
00056	10,5	11	Black



### Aschenbecher

ashtray  
cenicero  
cendrier



Deckel hochglanzpoliert, Behälter matt poliert, mit Windschutzdeckel  
lid mirror polished finish, container satin polished finish, with windcover  
con tapa antiviento pulida brillante y contenedor pulido efecto satinado  
couverture anti-vent brillant, corps poli mat satiné

	Ø cm	↑ cm
00052	12	5,5



Windaschenbecher

ashtray  
cenicero  
cendrier



	Ø cm	↑ cm	Farbe / Colour
83488	11,5	5	White
83489	11,5	5	Black



Windaschenbecher

ashtray  
cenicero  
cendrier



	Ø cm	↑ cm	Farbe / Colour
83610	10	4,0	White
83612	12	4,5	White
83611	10	4,0	Black
83613	12	4,5	Black



Aschenbecher

ashtray  
cenicero  
cendrier



	Ø cm	↑ cm	Farbe / Colour
83614	9,5	4,5	White
83616	9,5	4,5	Black



Aschenbecher

ashtray  
cenicero  
cendrier



**matt poliert, mit Windschutzdeckel**  
satin polished finish, with windcover  
acabado pulido satinado apilable, tapa para el viento  
poli mat, empilable, couvercle anti-vent

	Ø cm	↑ cm
00090	10	4,5
00091	12	4,5



Aschenbecher

ashtray  
cenicero  
cendrier



**matt poliert, hochwertige schwere Ausführung**  
satin polished finish, high quality, heavy gauge  
pulido satinado, alta calidad, apilable  
poli mat, empilable, belle qualité

	Ø cm	↑ cm
00048	8	3
00050	10	3





NEW

Windaschenbecher „SMOKY“

ashtray  
cenicero  
cendrier



Metall schwarz, mit abnehmbarem Deckel  
metal black, with removable lid  
metal negro, con tapa extraíble  
métal noir, avec couvercle amovible

	Ø cm	↑ cm	Farbe / Colour
00586	8,5	11,5	■



Windaschenbecher „SMOKY“

ashtray  
cenicero  
cendrier



Metall verzinkt, mit abnehmbarem Deckel  
metal galvanized, with removable lid  
metal galvanizado, con tapa extraíble  
métal galvanisé, avec couvercle amovible

	Ø cm	↑ cm
00578	8,5	11,5



NEW

Windaschenbecher 4er Set „MINI“

ashtray  
cenicero  
cendrier



	Ø cm	↑ cm	pcs.	Farbe / Colour
83620	6,5	5,5	4	■
83621	6,5	5,5	4	■



83621



83620

stapelbar  
stackable



Windaschenbecher „ELEMENT“

ashtray  
cenicero  
cendrier



Beton, mit möbelschonender Unterseite  
concrete, with non-scratching undersurface  
hormigón, con base anti rayaduras  
béton, avec revêtement antirayures

	Ø cm	↑ cm	pcs.
00570	10,5	5,0	3



hot price

Aschenbecher, 3er Set

ashtray, 3 pcs. set  
set de cenicero 3 piezas  
set de 3 mini cendriers



	Ø cm	↑ cm	pcs.	Farbe / Colour
00576	8	3	3	■



**Standascher „DIABOLO“**

standing ashtray  
cenicero de pie  
cendrier sur pied



für den Innen- und Außenbereich, inkl. 1,5 kg Sand, eine Ascheschale für die Sandbefüllung und ein Metallsieb

for in,- outdoor use, included a bag of sand and a metal sieve

uso en interior o exterior, incluye una bolsa de arena y embudo de metal

usage en intérieur ou extérieur, livré avec un sac de sable et entonnoir métal

	Ø cm	↑ cm
00574	40	60



**vielseitig nutzbar**  
versatile



**zerlegbar und stapelbar**  
dismountable and stackable

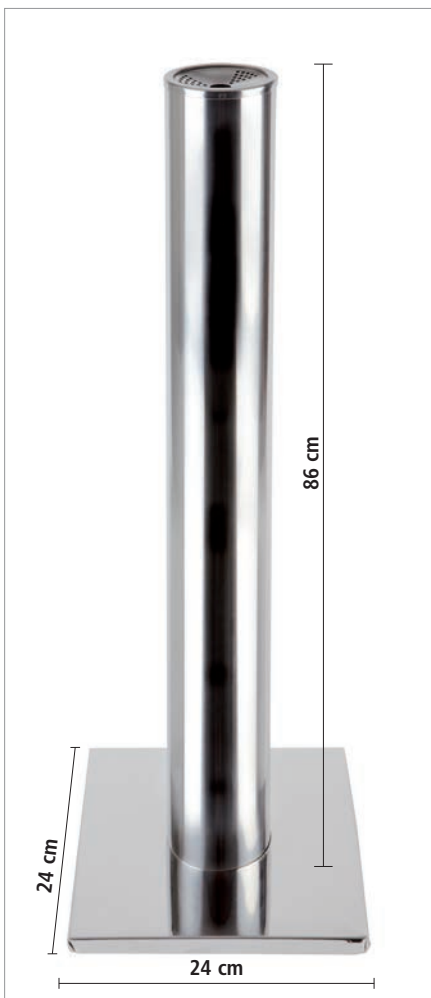

**Standascher / Abfalleimer „SMOKERS POINT“**

floor standing ashtray  
cenicero de pie  
cendrier sur pied



glanz poliert, mit herausnehmbaren Aschereinsatz

mirror polished finish, with ashtray insert and with litter bin

pulido acabado con cenicero y papelera

poli brillant inséré, extractible pour vidage facile

	Ø cm	↑ cm	ltr.
00579	9 / 24 x 24	86	3



**3 Liter Einsatz**  
3 litre ashtray insert





71400

### Rezeptionsglocke

ring bell  
timbre  
sonnette



	Ø cm	↑ cm	Farbe / Colour
71400	8,5	6,0	—
71433	10,0	6,5	—



### Standascher / Abfalleimer

litter bin / ashtray  
papelera con cenicero superior  
poubelle avec cendrier supérieur



mit herausnehmbaren Aschereinsatz und herausnehmbaren verzinkten Innenbehälter / Eimer  
with ashtray insert and litter bin  
con cenicero y papelera metálica  
cendrier et corbeille à détritrus

	Ø cm	↑ cm
00575	30	60



### Tretbeutelhalter

pedal bin  
soporte a pedal  
poubelle à pédale



geeignet für Müllbeutel bis 120 ltr., 110 x 70 cm  
suitable for bags up to 120 ltr., 110 x 70 cm  
apto para bolsas hasta 120 l., medidas sin bolsa 110 x 70 cm  
apte pour sacs de 120 l., dim. sans sac 110 x 70 cm

	cm	↑ cm
00580	59 x 43	96



leichte Bedienung, Trittmechanismus  
easy handling, step on bin



2 Lenkrollen mit Feststellern  
2 wheels with brakes





# Servier- & Küchenhelfer

servicing items & kitchentools

herramientas de cocina

outils de cuisine

**Kellen**  
**Schnitzer**  
**Wender**  
**Zangen**  
**Löffel**

cucharones  
talladores  
espátulas  
pinzas  
cucharas

ladles  
carvers  
turners  
tongs  
spoons

louches  
bourdes  
spatules  
pinces  
cuillères



220°C  
**POLYAMID**  
 BEST TECHNOLOGY

Das Profimaterial Polyamid besteht aus Nylon und Fiberglas. Hitzebeständig bis 220°C, extra hochwertige Profi-Qualität, gut geeignet für antihaftbeschichtete Pfannen, ergonomischer Griff.

Polyamide is made of nylon and fiberglass. Heat-resistant up to 220°C, extra high quality, perfect for non-stick-coated pots and pans, ergonomic handle.

Poliamide de nylon y fibra de vidrio. Brevemente al calor hasta 220°, calta calidad profesional, ideal para sartenes antiadherentes, mango ergonómico.

Polyamide de nylon et fibre de verre, haute résistance brièvement à la chaleur jusque 220°C, qualité professionnelle, idéal pour les poêles antiadhérentes, manche ergonomique.



**Bratenwender**

turner  
 espátula  
 spatule



.....  
 cm → cm  
 00603 11 x 9,5 Griff / handle 23



**Pfannenwender**

turner  
 espátula  
 spatule



.....  
 cm → cm  
 00600 11,5 x 9,5 Griff / handle 23



**Pfannenwender**

turner  
 espátula  
 spatule



.....  
 cm → cm  
 00604 15 x 7,5 Griff / handle 15



**Pfannenwender**

turner  
 espátula  
 spatule



.....  
 cm → cm  
 88642 13,5 x 9 Griff / handle 18



**Pfannenwender**

turner  
 espátula  
 spatule



.....  
 cm → cm  
 88640 13 x 6,5 Griff / handle 15



**Servierlöffel**  
 serving spoon  
 cuchara de servicio  
 cuillère de service



	cm	→ cm	
88608	12 x 7		Griff / handle 23
00607	12 x 7		Griff / handle 23 perforiert



**Schaumlöffel**  
 skimmer  
 espumadera  
 écumoire



	Ø cm	→ cm	
00602	11,5		Griff / handle 23



**Schöpflöffel**  
 ladle  
 cucharón  
 louche



	Ø cm	→ cm	ltr.
00606	9		0,1



**Toastzange**  
 sandwich tong  
 pinza para sandwich  
 pince à toasts



	cm	→ cm	
00601	11 x 8		Griff / handle 18



**Spaghettizange**  
 spoon  
 pinza espaguetis  
 pince universelle ou à spaghettis



	cm	→ cm	
88637	9 x 9		Griff / handle 15



**Salatzange**  
 salad tong  
 pinza ensalada  
 pince à salade



	cm	→ cm	
00605	10 x 6		Griff / handle 23

# STOP-TOOLS

Die STOP-Funktion verhindert, dass Gabel oder Löffel in das Gefäß rutschen.

The smart STOP-function prevent forks and spoon not to slip into the vessel.

La función STOP evita que los cubiertos se caigan dentro del recipiente. Antideslizante.

La fonction STOP empêche les couverts de glisser dans le récipient.



## Servierlöffel

serving spoon  
cuchara de servicio  
cuillère de service



**Materialdicke 2,5 mm, ergonomischer, rutschfester Griff**  
ergonomic antislip handle  
mango ergonómico antideslizante  
manche ergonomique antidérapante

.....  
cm → cm  
00834 10 x 7,5 Griff / handle 17



## Servierlöffel geschlitzt

slotted spoon  
cuchara de servicio  
cuillère de service



**Materialdicke 2,5 mm, ergonomischer, rutschfester Griff**  
ergonomic antislip handle  
cuchara de servicio ranurada  
cuillère de service rainurée

.....  
cm → cm  
00833 10 x 7,5 Griff / handle 17



## Schöpflöffel

ladle  
cucharón  
louche



**Materialdicke 2,5 mm, ergonomischer, rutschfester Griff**  
ergonomic antislip handle  
mango ergonómico antideslizante  
manche ergonomique antidérapante

.....  
Ø cm → cm  
00832 9 Griff / handle 17



## Fleischgabel

meat fork  
tenedor de carne  
fourchette à viande



**Materialdicke 2,5 mm, ergonomischer, rutschfester Griff**  
ergonomic antislip handle  
mango ergonómico antideslizante  
manche ergonomique antidérapante

.....  
cm → cm  
00831 10,5 x 4 Griff / handle 17





**Servierlöffel geschlitzt**  
 serving spoon  
 cuchara de servicio ranurada  
 cuillère de service rainurée



**ergonomischer, rutschfester Griff**  
 ergonomic antislip handle  
 mango ergonómico antideslizante  
 manche ergonomique antidérapante

00664                      cm                      → cm  
 11 x 7                      Griff / handle 25



**Servierlöffel**  
 serving spoon  
 cuchara de servicio  
 cuillère de service



**ergonomischer, rutschfester Griff**  
 ergonomic antislip handle  
 mango ergonómico antideslizante  
 manche ergonomique antidérapante

00662                      cm                      → cm  
 11 x 7                      Griff / handle 25



**Schöpföffel**  
 ladle  
 cucharón  
 louche



**ergonomischer, rutschfester Griff**  
 ergonomic antislip handle  
 mango ergonómico antideslizante  
 manche ergonomique antidérapante

00670                      cm                      → cm                      ltr.  
 9 x 8                      Griff / handle 25                      0,10



**Wender**  
 slotted turner  
 espátula para plancha  
 spatule pour le grill



**ergonomischer, rutschfester Griff**  
 ergonomic antislip handle  
 mango ergonómico antideslizante  
 manche ergonomique antidérapante

00668                      cm                      → cm  
 10 x 8                      Griff / handle 25



**Fleischgabel**  
 meat fork  
 tenedor de carne  
 fourchette à viande



**ergonomischer, rutschfester Griff**  
 ergonomic antislip handle  
 mango ergonómico antideslizante  
 manche ergonomique antidérapante

00666                      cm                      → cm  
 10 x 3,5                      Griff / handle 25



Schöpflöffel „PROFI“

ladle  
cacillo  
louche



	Ø cm	→ cm	ltr.
00711	6	Griff / handle 28	0,050
00712	7	Griff / handle 30	0,080
00713	8	Griff / handle 32	0,125
00714	9	Griff / handle 33	0,150
00715	10	Griff / handle 35	0,250
00716	11	Griff / handle 36	0,300



Schaumlöffel „PROFI“

skimmer  
espumadera  
écumoire



	Ø cm	→ cm
00721	10	Griff / handle 34
00722	12	Griff / handle 37
00723	14	Griff / handle 40



Wender „PROFI“

turner  
espátula  
spatule



	cm	→ cm
00730	10 x 11,5	Griff / handle 38



Servierlöffel „PROFI“

serving spoon  
cuchara de servicio  
cuillère de service



	cm	→ cm	
00671	11 x 7	Griff / handle 29	geschlitzt / slotted
00672	11 x 7	Griff / handle 29	



Spaghettilöffel „PROFI“

spaghetti spoon  
cuchara de espaguetis  
cuillère à spaghettis



	cm	→ cm
00673	10 x 7	Griff / handle 29



**Servierlöffel „CLASSIC“**

serving spoon  
cuchara de servicio  
cuillère de service



hochglanzpoliert, perforiert, Löcher Ø 4 mm, ergonomisch profilierter Hohl-Griff  
mirror polished finish, perforated, holes Ø 4 mm, ergonomic designed handle  
pulido brillante agujeros de Ø 4 mm, asa ergonómica  
brillant, trous Ø 4 mm, manche ergonomique

cm → cm  
75903 9,5 x 7 Griff / handle 23,5



**Servierlöffel „CLASSIC“**

serving spoon  
cuchara de servicio  
cuillère de service



hochglanzpoliert, ergonomisch profilierter Hohl-Griff  
mirror polished finish, ergonomic designed handle  
pulido brillante, asa ergonómica  
brillant, manche ergonomique

cm → cm  
75904 9,5 x 7 Griff / handle 23,5



**Schaumlöffel „CLASSIC“**

skimmer  
espumadera  
écumoire



hochglanzpoliert, ergonomisch profilierter Hohl-Griff  
mirror polished finish, ergonomic designed handle  
pulido acabado brillante, mango ergonómico  
brillant, manche ergonomique

Ø cm → cm  
75911 11 Griff / handle 26



**Pfannenwender geschlitzt „CLASSIC“**

turner  
espátula ranurada  
spatule rainurée



cm → cm  
75910 9 x 8 Griff / handle 21



**Tranchiergabel „CLASSIC“**

fork  
tenedor para carne  
fouchette à viande



hochglanzpoliert, ergonomisch profilierter Hohl-Griff, Zinkenlänge 8 cm  
mirror polished finish, ergonomic designed handle, length of prongs 8 cm  
pulido brillante, asa ergonómica, largo de las puas 8 cm  
brillant, manche ergonomique, dents long. 8 cm

cm → cm  
75905 8,5 x 2,5 Griff / handle 20,5



**Salatlöffel „CLASSIC“**

salad spoon  
cuchara para ensalada  
cuillère à salade

hochglanzpoliert, ergonomisch profilierter Hohl-Griff  
mirror polished finish, ergonomic designed handle  
inox brillante, asa ergonómica  
brillant, manche ergonomique



	cm	→ cm	
75902	8 x 6	Griff / handle 21,5	



**Salatgabel „CLASSIC“**

salad fork  
tenedor de servicio para ensalada  
fourchette de service pour la salade

hochglanzpoliert, ergonomisch profilierter Hohl-Griff  
mirror polished finish, ergonomic designed handle  
pulido brillante, asa ergonómica  
brillant, manche ergonomique



	cm	→ cm	
75901	8 x 6	Griff / handle 21,5	



60 ml

**Suppenkelle „CLASSIC“**

soup ladle  
cucharón de sopa  
louche de service

hochglanzpoliert, ergonomisch profilierter Hohl-Griff  
mirror polished finish, ergonomic designed handle  
pulido brillante, asa ergonómica  
brillant, manche ergonomique



	Ø cm	→ cm	ltr.
75907	7	Griff / handle 23	0,06



100 ml

**Suppenkelle „CLASSIC“**

soup ladle  
cucharón de sopa  
louche de service

hochglanzpoliert, ergonomisch profilierter Hohl-Griff  
mirror polished finish, ergonomic designed handle  
pulido brillante, asa ergonómica  
brillant, manche ergonomique



	Ø cm	→ cm	ltr.
75908	9	Griff / handle 24	0,1

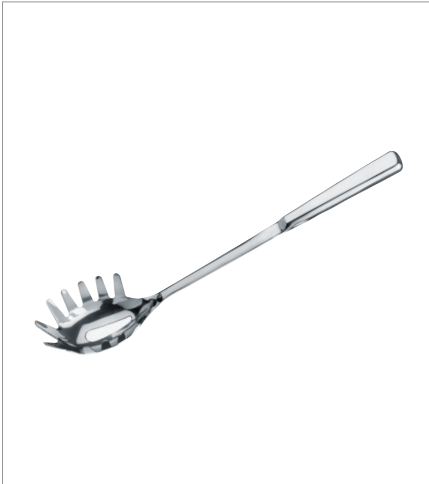

**Spaghettiheber „CLASSIC“**

spaghetti server  
tenedor espaguetis  
cuillère à spagettis



hochglanzpoliert, ergonomisch profilierter Hohl-Griff  
mirror polished finish, ergonomic designed handle  
acabado brillante, asa ergonómica  
brillant, manche ergonomique

	cm	→ cm	
75909	8 x 6,5	Griff / handle 22,5	



**Saucengießlöffel „CLASSIC“**

sauce / gravy ladle  
cucharón de salsa  
cuillère à sauce



hochglanzpoliert, ergonomisch profilierter Hohl-Griff, fugenlos  
mirror polished finish, ergonomic designed handle, seamless  
pulido brillante, asa ergonómica, sin soldadura  
brillant, manche ergonomique, monobloc (sans soudure)

	cm	→ cm	ltr.
75906	7 x 5,5	Griff / handle 22	0,02

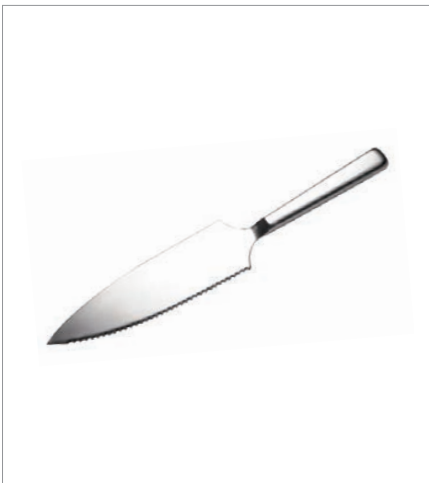

**Tortennmesser „CLASSIC“**

cake knife  
porcionador de pastel  
couteau à tarte



eine Kante gezahnt 15,5 cm  
one edge serrated 15,5 cm  
un borde serrado de 15,5 cm  
denté sur un côté à 15,5 cm

	cm	→ cm	
75912	5 x 1	Griff / handle 12	



**Tortenheber „CLASSIC“**

cake lifter  
pala de tartas  
pelle à gâteau



hochglanzpoliert, mit einer gezahnten Kante, ergonomisch profilierter Hohl-Griff  
mirror polished finish, one edge serrated, ergonomic designed handle  
pulido brillante, canto dentado, mango ergonómico  
brillant, bord microdenté, manche ergonomique

	cm	→ cm	
75900	8 x 5	Griff / handle 10,5	

# BANQUET



Die Vorlegeserie BANQUET ist die passende Ergänzung zum Servieren am Buffet. Durch die mattierte Oberfläche und das gebogene Griffende wird BANQUET praktischen und optischen Ansprüchen gerecht.

The series BANQUET is the perfect addition for serving at the buffet. Due to the matt surface and the curved handle, BANQUET meets practical and optical requirements.

La serie BANQUET es la adición perfecta para servir en el buffet. Debido a la superficie mate y al mango curvado, BANQUET cumple con requisitos prácticos y ópticos.

La série BANQUET est l'ajout parfait pour servir au buffet. Grâce à la surface mate et la poignée incurvée, BANQUET répond aux exigences pratiques et optiques.



## Salat- / Servierlöffel „BANQUET“

salad spoon / serving spoon  
cuchara para ensalada / cuchara de servicio  
cuillère à salade / cuillère de service



	cm	→ cm
00588	6 x 5	Griff / handle 17
00590	7,5 x 6	Griff / handle 21



## Salatgabel „BANQUET“

salad fork  
tenedor de servicio para ensalada  
fourchette de service pour la salade



	cm	→ cm
00589	6 x 5	Griff / handle 17
00591	7,5 x 6	Griff / handle 21



## Pfannenwender „BANQUET“

turner  
espátula  
spatule



	cm	→ cm
00587	10 x 7,5	Griff / handle 21



**Chafing Dish Löffel „BANQUET“**

serving spoon  
cuchara para servir  
cuillère de service



	cm	→ cm	
00592	11 x 6,5		Griff / handle 24
00593	11 x 6,5		Griff / handle 24 geschlitzt / slotted



**Dressinglöffel „BANQUET“**

dressing spoon  
cuchara de aliño  
cuillère à vinaigrette



	cm	→ cm	
00594	6 x 4		Griff / handle 30



**Schöpflöffel „BANQUET“**

ladle  
cucharón  
louche



	cm	→ cm	
00595	8,5 x 7,5		Griff / handle 24



**Fleischgabel „BANQUET“**

meat fork  
tenedor de carne  
fourchette à viande



	cm	→ cm	
00596	8 x 2,5		Griff / handle 13



**Serviergabel „BANQUET“**

fork  
tenedor de servicio  
fourchette de service



	cm	→ cm	
00597	9 x 4		Griff / handle 21



**Tortenheber „BANQUET“**

cake lifter  
pala de tartas  
pelle à gâteau



eine Kante gezahnt  
one edge serrated  
un borde serrado  
denté sur un côté

	cm	→ cm	
00598	14 x 6		Griff / handle 13



**Universalzange**

all - purpose tong  
pinza universal  
pince universelle

hochglanzpoliert  
mirror polished finish  
acabado brillante  
brillant



	cm	→ cm	
75830	7 x 5	25	

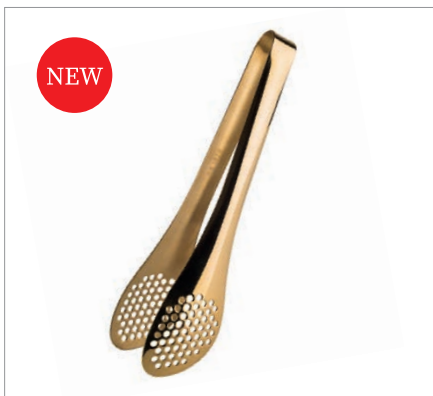

**Universalzange**

all - purpose tong  
pinza universal  
pince universelle

hochglanzpoliert, Gold-Look  
mirror polished finish, gold-look  
pulido brillante, dorado  
poli brillant, doré



	cm	→ cm	Farbe / Colour
75831	7 x 5	25	 gold-look



**Universalzange**

all - purpose tong  
pinza universal  
pince universelle

hochglanzpoliert, Kupfer-Look  
mirror polished finish, copper-look  
pulido brillante, cobre  
poli brillant, cuivre



	cm	→ cm	Farbe / Colour
75832	7 x 5	25	 copper-look



**Salatzange**

salad tong  
pinza ensalada  
pince à salade

hochglanzpoliert, beidseitig geschlitzt  
mirror polished finish, slotted on both side  
acabado brillante, agujereada en 2 lados  
brillant, perforéedes 2 côtés



	cm	→ cm
75801	5 x 2	24



**Spaghettizange**

spaghetti tong  
pinza espaguetis  
pince à spaghettis

hochglanzpoliert, fugenlos  
mirror polished finish, seamless  
acabado brillante, sin soldaduras  
brillant, monobloc



	cm	→ cm
75810	6 x 3	19





**Pinzettenzange**

fine tong / tweezer  
pinza de emplatar  
pince à dresser



hochglanzpoliert, geriffelte Grifffläche, schwere Qualität  
mirror polished finish, ribbed handle, heavy gauge  
acabado brillante, mango cómodo ranurado, alta calidad  
brillant, manche rainuré antiglisse, qualité extra

..... → cm  
75820 16



**Pinzettenzange**

fine tong / tweezer  
pinza de emplatar  
pince à dresser



hochglanzpoliert, geriffelte Grifffläche, schwere Qualität  
mirror polished finish, ribbed handle, heavy gauge  
acabado brillante, mango cómodo ranurado, alta calidad  
brillant, manche rainuré antiglisse, qualité extra

..... → cm  
75821 30



**Pinzettenzange**

fine tong / tweezer  
pinza de emplatar  
pince à dresser



hochglanzpoliert, geriffelte Grifffläche, schwere Qualität  
mirror polished finish, ribbed handle, heavy gauge  
acabado brillante, mango cómodo ranurado, alta calidad  
brillant, manche rainuré antiglisse, qualité extra

..... → cm  
75809 30



**Pinzettenzange**

fine tong / tweezer  
pinza de emplatar  
pince à dresser



hochglanzpoliert, geriffelte Grifffläche, abgerundete Spitzen vorne, schwere Qualität  
mirror polished finish, ribbed handle, rounded on the tops, heavy gauge  
acabado brillante, mango cómodo ranurado, alta calidad, puntas redondeadas  
brillant, manche rainuré antiglisse, qualité extra, pointes arrondies

..... → cm  
75808 14,5



**Salatzange**  
 salad serving tong  
 pinza de ensalada  
 pince à servir la salade



**hochglanzpoliert, einfache Handhabung**  
 mirror polished finish, convenient handling  
 pulido brillante, manejo cómodo  
 brillant, manipulation aisée

	cm	→ cm
00685	7,0 x 4,5	25



**Universalzange**  
 all - purpose tong  
 pinzas multiusos  
 pince multi-usages



**hochglanzpoliert, einfache Handhabung**  
 mirror polished finish, convenient handling  
 pulido brillante, manejo cómodo  
 brillant, manipulation aisée

	cm	→ cm
00688	7,0 x 4,5	25



**Brot- und Gebäckzange**  
 bread and pastry tong  
 pinza para pan y bollería  
 pince à pain ou viennoiseries



**hochglanzpoliert, einfache Handhabung**  
 mirror polished finish, convenient handling  
 pulido brillante, manejo cómodo  
 brillant, manipulation aisée

	cm	→ cm
00686	7,0 x 4,5	25



**Brot- und Gebäckzange**  
 bread and pastry tong  
 pinza para pan y bollería  
 pince à pain ou viennoiseries



**hochglanzpoliert, einfache Handhabung**  
 mirror polished finish, convenient handling  
 pulido brillante, manejo cómodo  
 brillant, manipulation aisée

	cm	→ cm
00687	7,0 x 4,5	25



**Allzweckzange**  
multipurpose tong  
pinza multi-usos  
pince universelle multi-usages



hochglänzend, mit Feder und Verschlussschieber, dekorative Greiferform  
high-gloss finish, with spring and retaining clip, decorative gripper form  
pulido brillante, con muelle y cierre deslizante, gancho con forma decorativa  
finition brillante, avec mécanisme de verrouillage, forme de pince décorative

	cm	→ cm
88643	4 x 3	24
88644	4 x 3	30
88645	4 x 3	40



**Aufschnitt- / Allzweckzange**  
sausage tong  
pinza salchichas  
pince à saucisses



hochglanzpoliert, fugenlos  
mirror polished finish, seamless  
pulido brillante, sin soldadura  
brillant, monobloc

	cm	→ cm
75806	3 x 2,5	16



**Gebäckzange**  
pastry tong  
pinza para pasteles  
pince à gâteaux



hochglanzpoliert, fugenlos, extra schwere Qualität  
mirror polished finish, seamless, extra heavy gauge  
pulido brillante, sin soldadura, alta calidad, resistente  
brillant, monobloc, qualité extra, robuste

	cm	→ cm
75807	8,5 x 4	27,5



**Universalzange**  
all - purpose tong  
pinza universal  
pince universelle



hochglanzpoliert, einseitig geschlitzt  
mirror polished finish, slotted on one side  
acabado brillante, agujereada en un lado  
brillant, perforée d'un seul côté

	cm	→ cm
75800	5 x 2	24



**Gebäckzange**

pastry tong  
pinza para pasteles  
pince à gâteaux

hochglanzpoliert, perforiert  
mirror polished finish, perforated  
pulido brillante, perforado  
brillant, perforée



	cm	→ cm
75804	6,5 x 3	19,5



**Gebäck- / Tortenzange**

pastry tong  
pinza para pasteles  
pince à gâteaux

hochglanzpoliert, fugenlos  
mirror polished finish, seamless  
acabado brillante, sin soldadura  
brillant, monobloc



	cm	→ cm
75803	7 x 3,5	17,5



**Eisportionierer**

ice cream scoop  
cuchara para helado  
cuillère à glace

hochglanzpoliert, mit Edelstahlfeder (physikalisch bedingt nicht korrosionsbeständig)  
mirror polished finish, spring steel, spring is not stainless  
pulido brillante, muelle de acero especial, no resistente al óxido  
poli brillant, ressort acier spécial, non résistant à l'oxydation



	∅ cm	→ cm	ltr.
71006	6,5	23,5	1/12
71005	6,0	22,5	1/16
71004	5,5	22,0	1/20
71003	5,0	22,0	1/24
71002	5,0	21,5	1/30
71001	4,5	21,0	1/36



**Messlöffelsatz**

set measuring spoon  
juego de cucharas medidoras  
jeu de cuillère à mesure

Löffel hochglanzpoliert, Stiele matt poliert, Skalierung:  
1 Esslöffel, 1 Teelöffel, 1/2 Teelöffel, 1/4 Teelöffel

bowl mirror polished finish, handles satin polished finish, measures:  
table spoon, tea spoon, 1/2 tea spoon, 1/4 tea spoon

bol medidor brillante, mango mate medidas:

1 cuchara de sopa, 1 cuchara de té, 1/2 cuchara de té, 1/4 cuchara de té

corps brillant, manche mat, mesures:

1 cuillerée à soupe, 1 cuillerée à thé, 1/2 cuillère à thé, 1/4 de cuillère à thé



	cm
75600	14 x 4,5



**Feinkostlöffel, 6er Set**  
 delicatessen spoon, 6 pcs. set  
 cuchara gourmet, set de 6  
 cuillère gourmet, set de 6



	∅ cm	→ cm	pcs.	Farbe / Colour
88627	6	23	6	White



**Feinkostlöffel, 6er Set**  
 delicatessen spoon, 6 pcs. set  
 cuchara gourmet, set de 6  
 cuillère gourmet, set de 6



	∅ cm	→ cm	pcs.	Farbe / Colour
88628	6	23	6	Black



**Feinkostlöffel, 6er Set**  
 delicatessen spoon, 6 pcs. set  
 cuchara gourmet, set de 6  
 cuillère gourmet, set de 6



	∅ cm	→ cm	pcs.	Farbe / Colour
88626	6	23	6	Light Blue



**Feinkost- / Olivenlöffel, 6er Set**  
 delicatessen / olives spoon, 6 pcs. set  
 cuchara gourmet / para aceitunas, set de 6  
 cuillère gourmet / à olives, set de 6



geloht  
 perforated  
 perforadas  
 perforées

	cm	→ cm	pcs.	Farbe / Colour
88598	6 x 9	27	6	Black



**Dressinglöffel**  
 dressing spoon  
 cuchara de aliño  
 cuillère à sauce



aus Kunststoff  
 plastic  
 plástico  
 plastique

	∅ cm	→ cm	ltr.	Farbe / Colour
88636	6	34	0,05	White
88609	6	34	0,05	Black

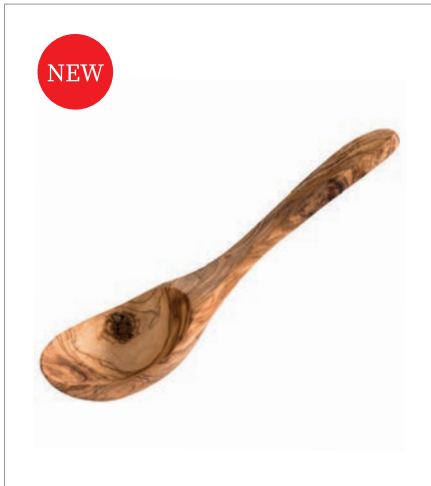

**Löffel**

spoon  
cuchara  
cuillère

HOLZ  
WOOD



aus Olivenholz, ideal für Reis, Gemüse...

olive wood, ideal for rice, vegetables...

madera de olivo, ideal para arroz, verduras...

en bois d'olivier, idéal pour le riz, les légumes...

.....  
cm → cm  
.....  
00840 9,5 x 8,5 17,0



**Salatbesteck, 2er Set**

spoon, 2 pcs. set  
cuchara, set de 2  
cuillère, set de 2

HOLZ  
WOOD



aus Olivenholz

olive wood

madera de olivo

en bois d'olivier

.....  
cm → cm  
.....  
00841 9,5 x 8,5 17,0

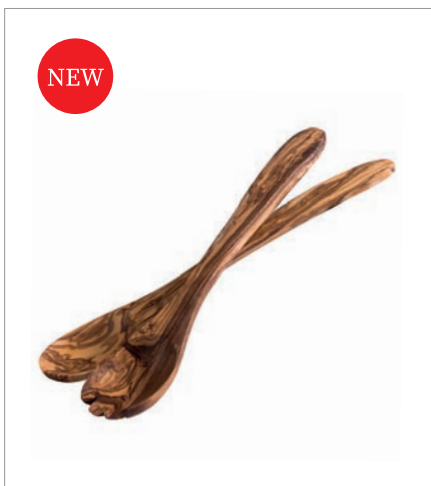

**Salatbesteck, 2er Set**

spoon, 2 pcs. set  
cuchara, set de 2  
cuillère, set de 2

HOLZ  
WOOD



aus Olivenholz

olive wood

madera de olivo

en bois d'olivier

.....  
cm → cm  
.....  
00842 7,5 x 6,0 22,5



**Löffel**

spoon  
cuchara  
cuillère

HOLZ  
WOOD



aus Akazienholz, ideal für Reis, Gemüse...

acacia wood, ideal for rice, vegetables...

madera de acacia, ideal para arroz, verduras...

bois d'acacia, idéal pour le riz, les légumes...

.....  
cm → cm  
.....  
00599 9 x 6,5 23,5



### Kugelausstecher - doppelt „ORANGE“

melon baller - double  
vaciador doble de bola  
moule à boule double



zum Formen von Kugeln aus Obst, Gemüse oder Butter, Edelstahl mit geschärften Rändern  
to form balls out of fruits, vegetables, butter, etc., stainless steel with sharpened edge  
para hacer bolas con frutas, verduras, mantequilla, etc. acero inoxidable con borde afilado  
pour faire des boules de fruits, légumes, beurre, etc. inox, bord affûté

	∅ cm	→ cm
88810	2,2 + 2,5	16,5
88811	2,2 + 3,0	17



### Fadenschneider / Zester „ORANGE“

decorator / zester  
cuchillo de decoración cincelador  
couteau zesteur



zum Abziehen von feinsten Schalenstreifen, ideal zum Dekorieren von Torten und Desserts  
to peel off very fine stripes of paring, these stripes are ideal to decorate desserts, cakes, etc.  
para pelar tiras muy finas, ideal para decorar postres, tartas, etc.  
pour couper en lanières fines, idéal pour la décoration de gâteaux et desserts, etc.

	∅ cm	→ cm
88823	0,2 + 0,5	14,5



### Ziseliermesser „ORANGE“

canele / decorating knife  
cuchillo de decoración cincelador acanalado  
couteau zesteur cannelé



zum Einritzen von Linien und Mustern in hartschaliges Obst und Gemüse, Edelstahl mit geschärften Rändern  
to score lines or design in hard fruits and vegetables, stainless steel with sharpened edge  
para dibujar líneas en frutas o verduras de piel dura, acero inoxidable con borde afilado  
pour découper des lignes et motifs sur fruits et légumes à peau dure ou pour peler les zestes des citrons ou oranges, inox, bord affûté

	→ cm
88826	15

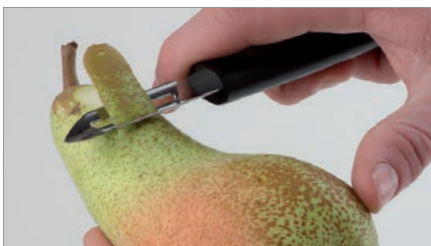

### Sparschäler „ORANGE“

peeler  
pelador  
peleur



für Links- und Rechtshänder geeignet, mit zwei starren Klingen aus extra geschärftem + gehärtetem Edelstahl

useable left- and right handed, with 2 inflexible blades made out off sharpened, extra hardened stainless steel

para diestros y zurdos, con 2 cuchillas rígidas inox afiladas y muy resistentes

pour gauchers ou droitiers, 2 lames rigides affûtées en inox extra-résistant

	→ cm
88827	17



**Pendelschäler „ORANGE“**

swivel peeler  
pelador reversible  
éplucheur droitier/gaucher



für Links- und Rechtshänder, ideal für das Schälen von Tomaten, mit 2 beweglichen Klingen  
suitable for right and left handed, ideal to peel tomatoes, with 2 flexibles blades  
apto para diestros y zurdos, ideal para pelar tomates, con 2 hojas flexibles  
pour gauchers ou droitiers, idéal pour peler les tomates, 2 lames flexibles

→ cm

88850 16,5



**Cocktailmesser**

bar knife  
cuchillo para cóctel  
couteau cocktail



mit 2 Zinken zum Aufspießen von Zitrusseiben  
with 2 prongs to pick up slices of lemon  
con 2 dientes para pinchar las rodajas de limón, etc.  
avec 2 dents pour les rondelles de citron et autres décorations

→ cm

88846 21



**Pizzateigschneider „ORANGE“**

pizza cutter  
cortador de pizza  
roulette à pizza



zum einfachen Zerteilen von Pizza  
to cut pizza easily  
para cortar pizza fácilmente  
pour une coupe facile de la pizza

Ø cm → cm

88829 6 18,5



**Pendelschäler „ORANGE“**

swivel peeler  
pelador lama pivotante  
peleur lame pivotante



zum schnellen und sparsamen Schälen von Obst und Gemüse, mit beweglicher Klinge  
to peel fruits and vegetables with flexible blade  
para pelar frutas y verduras con hoja flexible  
pour couper des fruits et légumes avec lame flexible

→ cm

88834 17



**Apfelentkerner „ORANGE“**

apple corer  
descorazonador de manzana  
vide-pomme



durch leichtes Drehen kann das Kerngehäuse von Äpfeln, Birnen und anderen Früchten sorgsam herausgeholt werden, Edelstahl mit geschärften Rändern  
with a light turn cores of apples, pears and other fruits can be cut off easily, stainless steel with sharpened edge  
para descorazonar muy fácilmente manzanas, peras y otras frutas  
pour évider facilement les pommes, poires ou autres fruits

Ø cm → cm

88836 2,2 21





**Austernöffner „ORANGE“**

oyster knife  
 abre ostras  
 couteau à huîtres



zum einfachen Aufbrechen von Austern, mit Fingerschutz, Edelstahl mit geschärften Rändern  
 to open oysters easily, with guard, stainless steel with sharpened edge  
 para abrir ostras fácilmente con protección para los dedos, acero inoxidable con punta afilada  
 pour ouvrir facilement les huîtres avec protection pour les doigts, inox, pointe affûtée

→ cm  
 88839 14,5



**Austernmesser „ORANGE“**

oyster knife  
 abre ostras  
 couteau à huîtres



Edelstahl-Klinge zum Einstechen in die Schale, mit Fingerschutz  
 to open oysters easily, with guard  
 para abrir ostras fácilmente con protección para los dedos  
 pour ouvrir facilement les huîtres avec protection pour les doigts

→ cm  
 88840 15



**Dekoriermesser „ORANGE“**

decorating knife „canalé“  
 cuchillo acanalador  
 couteau cannelé



gezahnte Klinge aus geschärftem Edelstahl  
 serrated sharpened blade, stainless steel  
 hoja de sierra afilada, acero inoxidable  
 lame inox microdentée

→ cm  
 88843 19



**Käsehobel „ORANGE“**

cheese slicer  
 rebanador de queso  
 couteau tranche-fromage



zum Schneiden von dünnen Käsescheiben  
 to cut thin slices of cheese  
 para cortar lonchas finas de queso  
 pour couper de fines tranches de fromage

→ cm  
 88853 21,5



**Streichpalette „BLUE“**

spatula  
espátula  
spatule



**flexible Edelstahl-Klinge, rutschfester Griff, hitzebeständig**  
flexible blade stainless steel, non-slip handle, heat-resistant  
hoja flexible acero inoxidable mango polipropileno termoresistente anti-deslizante  
lame inox flexible, manche antiglisse en polypropilène thermorésistant

	cm	→ cm
88920	35 x 5	48,5
88921	30,5 x 4,5	43,5
88922	25 x 4	38,0
88923	20 x 3	33,5



**Winkelpalette „BLUE“**

spatula  
espátula  
spatule



**flexible Edelstahl-Klinge**  
flexible blade stainless steel  
hoja flexible acero inoxidable  
lame inox flexible

	cm	→ cm
88928	17 x 5	30



**Gebäckpalette „BLUE“**

pastry spatula  
paleta pastelera  
spatule pâtissière



**flexible Edelstahl-Klinge**  
flexible blade stainless steel  
hoja flexible acero inoxidable  
lame inox flexible

	cm	→ cm
88932	17 x 7,5	29,5



**Wender „BLUE“**

turner  
espátula  
spatule



**flexible Edelstahl-Klinge**  
flexible blade stainless steel  
hoja flexible acero inoxidable  
lame inox flexible

	cm	→ cm
88933	15 x 6	27,5



**Winkelpalette „BLUE“**

turner  
espátula  
spatule



flexible Edelstahl-Klinge  
flexible blade stainless steel  
hoja flexible acero inoxidable  
lame inox flexible

	cm	→ cm
88935	34 x 5	47,5
88937	24 x 4	36
88938	18,5 x 3	32



**Wender „BLUE“**

turner  
espátula  
spatule



flexible Edelstahl-Klinge  
flexible blade stainless steel  
hoja flexible acero inoxidable  
lame inox flexible

	cm	→ cm
88939	24 x 7,5	37,5



**Wender „BLUE“**

turner  
espátula  
spatule



perforiert, flexible Edelstahl-Klinge  
perforated, flexible blade stainless steel  
hoja flexible inox agujereada  
lame ajourée inox flexible

	cm	→ cm
88940	24,5 x 7,5	37,5



**Wender „BLUE“**

turner  
espátula para plancha  
spatule



flexible Edelstahl-Klinge  
flexible blade stainless steel  
hoja flexible acero inoxidable  
lame inox flexible

	cm	→ cm
88941	20 x 7,5	33
88942	15 x 9	28



**Spachtel / Schaber „BLUE“**

scraper  
 espátula plancha  
 spatule coudée spéciale grill

starre Edelstahl-Klinge  
 rigid blade stainless steel  
 hoja rígida acero inoxidable  
 lame inox rigide



	cm	→ cm
88929	11 x 10	25



**Spachtel / Fettabstecher „BLUE“**

scraper  
 espátula plancha  
 spatule coudée spéciale grill

starre Edelstahl-Klinge  
 rigid blade stainless steel  
 hoja rígida de acero inoxidable  
 lame rigide inox



	cm	→ cm
88946	17 x 10	30
88947	15 x 7,5	28



**Aufstrichmesser „BLUE“**

sandwich knife  
 cuchillo para untar  
 couteau à tartiner

flexible Edelstahl-Klinge  
 flexible blade stainless steel  
 hoja flexible acero inoxidable  
 lame inox flexible



	cm	→ cm
88948	8,5 x 3	18,5



**Teigschaber / Abstecher „BLUE“**

dough scraper  
 corta pasta  
 coupe-pâte

starre Edelstahl-Klinge  
 rigid blade stainless steel  
 hoja rígida de acero inoxidable  
 lame rigide inox



	cm
88930	15,5 x 8



**Wender „PRO“**

turner  
espátula  
spatule



flexible Edelstahl-Klinge  
flexible blade stainless steel  
hoja inox flexible  
lame inox flexible

	cm	→ cm
88701	12 x 8,7	29



**Pizzaschneider „BLUE“**

pizza cutter  
cortador de pizza  
coupe-pizza



ergonomischer Griff  
ergonomic handle  
mango ergonómico  
manche ergonomique

	Ø cm	→ cm
88949	10	20



**Pizzaschneider „PRO“**

pizza cutter  
cortador de pizza  
coupe-pizza



ergonomischer Griff  
ergonomic handle  
mango ergonómico  
manche ergonomique

	Ø cm	→ cm
88727	10	25



**Pizzaschaufel**

pizza peel  
pala de pizza  
pelle à pizza



	cm	→ cm
88080	35 x 30,5	90
88081	35 x 30,5	130



**Eierschneider**

egg cutter  
corta huevos  
coupe-oeufs



zum Längs- und Querteilen von hart gekochten Eiern

to cut hard-boiled eggs  
corta a rodajas un huevo duro  
en rondelles

	cm	↑ cm
88099	14,5 x 8	2,5



**Hummerbrecher**

lobster cracker  
pinza bogavante  
pince à homard



	cm
74201	14 x 5,5

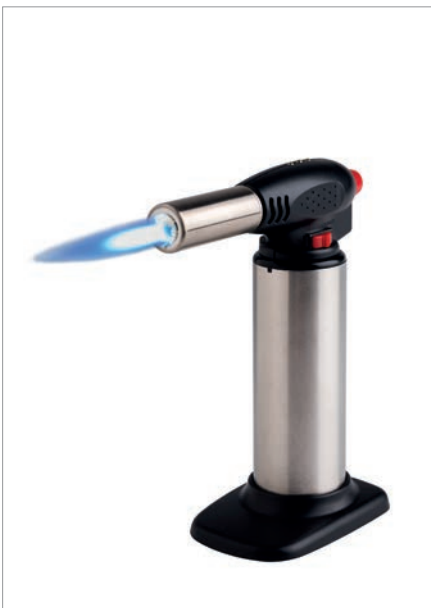

**Flambierbrenner**

chefs blow torch  
soplete de cocina para flambear  
chalumeau de cuisine



mit handelsüblichem Feuerzeuggas auffüllbar, Flamme einstellbar bis ca. 1300° C, Brenndauer von min. 60 Minuten

to be filled with commercial lighter gas, flame adjustable up to approx. 1300° C, burning time of at least 60 minutes

rellenable con gas de mechero comercial, llama ajustable hasta 1300° C, tiempo de combustión de al menos 60 minutos

rempli avec gaz pour briquet commercial, flamme réglable jusqu'à 1300° C, temps de combustion d'au moins 60 minutes

	Ø cm	↑ cm
77315	4,5	16,5



**Rezeptionsglocke**

ring bell  
timbre  
sonnette



	Ø cm	↑ cm	Farbe / Colour
71400	8,5	6,0	■
71433	10,0	6,5	■



**Schneebeesen**

whisk  
batidor  
fouet



	Drähte / wires	→ cm
00744	8	28
00745	8	33
00746	8	38
00747	8	43
00740	8	48



**Passiersieb**

strainer  
colador  
passoire



feines Siebgewebe mit ca. 6 Löchern pro 1 cm<sup>2</sup>

fine mesh with 6 holes per 1 cm<sup>2</sup>  
malla fina con 6 agujeros por 1 cm<sup>2</sup>  
toile fine avec 6 trous pour 1 cm<sup>2</sup>

	Ø cm	↑ cm	Stiellänge → cm
88617	26	12	28
88618	30	17	28



**Passiersieb**

strainer  
colador  
passoire



feines Siebgewebe mit ca. 6 Löchern pro 1 cm<sup>2</sup>

fine mesh with 6 holes per 1 cm<sup>2</sup>  
malla fina con 6 agujeros por 1 cm<sup>2</sup>  
toile fine avec 6 trous pour 1 cm<sup>2</sup>

	Ø cm	↑ cm	Stiellänge → cm
74700	14	5,0	16
74701	16	6,0	16
74702	18	7,5	16
74703	20	8,5	16
74705	24	11,0	17
74706	26	11,0	17



**Passiersieb**

strainer  
colador  
passoire



mit Doppelnetz, Netz außen: ca. 2 Löcher pro 1 cm, Netz innen: ca. 5 Löcher pro 1 cm

with double mesh, outer mesh about 2 holes per cm, inner mesh about 5 holes per cm  
con malla doble, malla exterior aprox. 2 agujeros /cm, interior aprox. 5 agujeros /cm  
avec double étamine, extérieure env. 2 trous/cm, intérieure environ 5 trous/cm

	Ø cm	↑ cm	Stiellänge → cm
74721	20	8	18
74722	24	10	28

74721  
**Doppelnetz . double mesh**



**Back- / Frittierlöffel**

skimmer / spider  
espumadera para fritos  
écumoire à friture

elektropoliert, sehr stabile Ausführung  
electro polished, heavy gauge  
electro pulido, alta calidad  
poli électrolythique, qualité extra



	∅ cm	→ cm	
74402	16	33,5	
74404	20	33,5	



**Pommes-Frites-Seiher**

fry dripping tray  
escurridor de fritos  
égouttoir à friture

herausnehmbarer Locheinsatz, mit Handgriff  
removable drainer, with handle  
fondo de colador desmontable, con asa  
fond démontable, avec poignée



	∅ cm	↑ cm	
00785	39	19	



**Salzstreuer**

salt shaker  
salero  
salière

**Pommes-Frites Streuer mit Schraubkappe**  
for french fries, cover to screw  
para patatas fritas, tapa de rosca  
pour les frites, couvercle à visser



	∅ cm	↑ cm	
00772	8	17	stainless steel
00779	8	17	aluminium



**Gazespitzsieb**

conical strainer with wire gauze  
colador chino de malla  
chinois renforcé avec maille fine

hochglanzpoliert, mit rundem Hohlgriff, ca. 9 Löcher pro 1 cm<sup>2</sup>  
mirror polished finish, 9 holes per 1 cm<sup>2</sup>  
pulido acabado brillante, mango hueco, 9 agujeros por 1 cm<sup>2</sup>  
brillant, manche creux, 9 trous pour 1 cm<sup>2</sup>



	∅ cm	↑ cm	→ cm
88718	20	15	24
88717	24	19	24





**Spitzsieb**  
conical strainer  
colador cónico  
chinois



mit Lochung Ø 1,5 mm, auch in der Kegelspitze, mit Flachstiel, mit Stützstiel zum Einhaken in den Topfrand

with Ø 1,5 mm holes (including the tip), with flat handle, with supporting hook  
con agujeros finos de Ø 1,5 mm (incluida la punta), con mango plano y gancho  
perforations fines 1,5 y compris à la pointe, manche plat et crochet

	Ø cm	↑ cm	→ cm
00771	23	18	16,5



**Likör- und Fondantrichter**  
confectionery funnel  
embudo dosificador  
entonnoir à piston



ergonomischer Griff aus Kunststoff, mit 3 Düsen 2, 4, 6 mm, inkl. Ständer u. Auffangschale  
ergonomic plastic handle, with 3 different nozzles 2, 4, 6 mm, incl. wire rack a. dripping dash  
mango ergonómico con 3 boquillas, 2, 4, 6 mm, incl. pie de alambre y bandeja recoge gotas  
manche plastique ergonomique, 3 douilles de 2, 4 et 6 mm, inclut pied avec ramasse-gouttes

	Ø cm	↑ cm	ltr.
77338	20	34	1,5



**Gemüsehobel, Mandoline**  
mandolin  
mandolina  
mandoline



mit 7 verschiedenen Klingen (Breite 10 cm), Anti-Rutsch-Gestell, Schutzabdeckung  
with 7 interchangeable blades (width 10 cm), non-slip folding stand, safety guard  
con 7 cuchillas intercambiables (corte 10 cm), pie plegable anti-deslizante, carro de seguridad  
7 peignes interchangeables (largeur 10 cm), pied repliable anti-glisse, chariot

	cm	↑ cm
88688	40,5 x 12	5 / 25



- A** 7 verschiedene Klingen  
7 interchangeable blades
- B** Praktische Transportbox  
Practical transport box



**Wasserbadschüssel**  
bain marie bailing bowl  
cazo para baño maría  
réceptier bain-marie



hochglanzpoliert, mit Drahtgriff Ø 5 mm  
mirror polished finish, with wire handle Ø 5 mm  
inox pulido brillante, mango varilla Ø 5 mm  
inox brillant, manche fil épaisseur Ø 5 mm

	Ø cm	↑ cm	→ cm	ltr.
74731	18	9	15	1,5



**Mess- / Universalkanne**

graduated jug  
jarra medidora universal  
pichet mesureur universel



**matt poliert, mit Maßskalierung innen**  
satin polished finish, with stamped liter scale inner  
acabado satinado, con graduación en el interior  
mat, graduations à l'intérieur

	Ø cm	↑ cm	ltr.
30054	12	13	1
30055	14	17	2



**Messbecher**

graduated jug  
jarra graduada  
pichet gradué



**außen hochglanzpoliert, innen matt poliert, mit Maßskalierung außen**  
outside mirror polished finish, inside satin polished finish, with stamped liter scale  
exterior pulido brillante, interior satinado con escalado en litros  
extérieur brillant, intérieur satiné, graduation en litres

	Ø cm	↑ cm	ltr.
30045	10	14	1



**Messbecher**

measuring cup  
jarra graduada  
pichet gradué



**mit geschlossenem Griff, mit geprägter Maßskalierung außen, l- und ml-Liter-Einteilung**  
with handle, with stamped printed liter and ml scale  
con asa, graduación ml.  
avec anse, graduation en ml.

	Ø cm	↑ cm	ltr.
30046	9,5	14	0,5
30047	12	17	1
30048	15,5	21	2
30049	17,5	23,5	3
30057	20,5	27,5	5



**Schaumpeiseringe, 5er Set**

mousse ring, 5 pcs. set  
juego aros para emplatar o para semifríos  
jeu de cercles à mousse inox, ronds



**5-teilig: 4 Formen + 1 Verdichter, matt poliert, fugenlos**  
5 pcs. set: 4 shapes and 1 pusher, satin polished finish, seamless  
juego de 5 piezas: 4 aros redondos y 1 pulsador, para dar forma, satinado sin soldadura  
jeu de 5 pièces: 4 cercles et 1 poussoir. Idéal pour dressage sur assiette ou mousse, mat satiné, sans soudure

	Ø cm	↑ cm
00110	6	4,5
00113	8	4,5



### Schaumspeisering

mousse ring  
aro redondo para semifríos  
cercle à mousse rond

**matt poliert, fugenlos**

satin polished finish, seamless  
acabado satinado sin soldadura  
mat satiné, sans soudure



	Ø cm	↑ cm
00098	6	4,5
00099	7	4,5
00092	8	4,5
00093	10	4,5
00094	12	4,5



### Dariolformen, 2er Set

daiquiri moulds, 2 pcs. set  
juego 2 flaneras  
jeu de 2 moules à flan

**hochglanzpoliert**

mirror polished finish  
acabado brillante  
brillant



	Ø cm	↑ cm	ltr.
00106	6,5	4,5	0,1



### Tortenring

cake setting ring  
aro de tarta  
cercle à gâteaux

**stufenlos verstellbar**

adjustable  
ajustables  
ajustables



	Ø cm	↑ cm	
00040	16,5 - 32	7	ohne Griff / without handle



### Backform

baking pan  
marco pastelero  
forme à gateaux

**stufenlos verstellbar, aus flexiblem Edelstahl**

adjustable  
ajustable  
ajustable



	cm	↑ cm
00042	19 x 28 - 34 x 54	5



## Tablett „VINTAGE“

tray  
bandeja  
plateau



**Edelstahl-Look vintage**  
stainless steel vintage look  
acero inoxidable look vintage  
acier inox look vintage

	cm	↑ cm
30130	26,0 x 13,5	1,5
30131	34,0 x 18,0	1,5
30132	38,0 x 26,5	1,5
30133	25,5 x 16,0	3,0



## Ausstellblech / Thekenblech

display tray  
bandeja pastelera  
plaque pâtissière



**hitzebeständig bis 230°C**  
heat-resistant up to 230°C  
resistente al calor hasta 230 °C  
résistant à la chaleur jusqu'à 230°C

	cm	↑ cm
13377	40 x 25	2
13378	48 x 32	2
13379	60 x 40	2



## Tablett „TREND“

baking sheet  
bandeja  
plateau



**ein Backblech wird zum Serviertablett**  
a baking sheet which becomes a serving tray  
una bandeja de hornear que se convierte en una bandeja de servir  
un moule qui devient un plateau de service

	cm	↑ cm
13380	32,0 x 21,5	2



## Rechteckschalen

container  
cubeta  
bac



	cm	↑ cm	ltr.
11941	30 x 21,0	6,5	2
11942	34 x 23,5	7,0	3
11943	48 x 33,0	8,0	8



**Mehlschaufel**

scoop  
pala  
pelle à farine



stehende Schaufel, auch für Flüssigkeiten geeignet  
standing scoop, also applicable for liquids  
pala, ápto también para líquidos  
adaptée pour poudres et liquides

	cm	↑ cm	ltr.	Farbe / Colour
00610	25 x 9	4,5	0,25	—
00611	31 x 12	5,5	0,5	—
00612	35 x 13	6	0,7	—



**Seiher**

strainer  
colador  
passoire



mit 2 Muschelgriffen  
with 2 shell shaped grips  
con dos asas  
à 2 anses moulées

	Ø cm	↑ cm
00780	36	19



**Backhandschuhe**

baking mittens  
manoplas de panadero  
gants de boulanger

Leder, gefüttert, Einheitsgröße, mit Stulpen, extrem hitzebeständig bis 250°C  
leather, inner lining, one size, with cuffs, extremely heat resistant up to 250°C  
cuero interior forrado, talla única, resiste a temperaturas hasta 250°C  
cuir intérieur doublé, taille unique, résiste à maxi 250°C

	→ cm
88090	45



**Pizzaschaufel**

pizza peel  
pala de pizza  
pelle à pizza



	cm	→ cm
88080	35 x 30,5	90
88081	35 x 30,5	130



2 Pressringe für Zitrone und Limette

**Limetten- / Zitronenpresse**

lime- / lemonpress  
 exprimidor de limón / lima  
 presse citron



	cm	↑ cm
93214	21 x 7	5



**Limettenpresse**

lime press  
 prensa de limón  
 presse citron



	cm	↑ cm
93189	21 x 7	5



**Zitruspresse**

citrus squeezer  
 exprimidor cítricos  
 presse-citron



hochglanzpoliert, 2-teilig  
 mirror polished finish, 2 pcs.  
 pulido brillante, 2 piezas  
 brillant, 2 pièces

	Ø cm	↑ cm	ltr.
71431	12 / 17	10,5	0,35



30260

**Schüssel**

bowl  
 ensaladera  
 saladier



	Ø cm	↑ cm	ltr.	Farbe / Colour
30260	32,5	10	4	_____
30263	40	12	8	_____
30266	47	14,5	14	_____



77350

77352

**Pinsel**

brush  
 brocha  
 pinceau pâtissier



weißgebleichte, naphtalinfreie Borsten, temperaturbeständig von -40°C bis +95°C

bleached bristles, heat-resistant from -40°C to +95°C  
 cerdas blanqueadas, resistencia térmica -40°C hasta +95°C  
 soies blanchies sans naphtaline, résistance de - 40°C à + 95°C

	cm	→ cm
77350	4 x 1	23,5
77352	6 x 1	24



Vorratsglas „WOODY“

canister with lid  
bote con tapa  
pot en verre avec couvercle



Holzdeckel mit Silikondichtung  
wooden lid with silicone gasket



Glasbehälter mit Holzdeckel, aromadichter Verschluss

glass container, aroma-tight screw cap  
recipiente de cristal, tapa con cierre hermético para conservar el aroma  
récipient en verre, couvercle avec fermeture hermétique pour conserver l'arôme

	Ø cm	↑ cm	ltr.
82255	14 x 14	11,0	1,0
82256	14 x 14	17,0	2,0
82257	14 x 14	21,5	2,5



Vorratsglas „CLASSIC“

canister with lid  
bote con tapa  
pot en verre avec couvercle



inkl. Glasdeckel mit Dichtung. Somit bleibt Ihre Ware frisch  
incl. glass lid with seal. Thus, your goods remain fresh  
incl. tapa de vidrio con junta. Por lo tanto, sus productos permanecen frescos  
y compris couvercle en verre avec joint. Ainsi, vos marchandises restent fraîches.

	Ø cm	↑ cm	ltr.
82250	11,5	16,0	0,9
82251	14,0	21,5	2,0
82252	18,0	26,0	4,0
82253	20,0	30,0	6,0



2 ltr.

**Vorratsglas mit luftdichtem Klappdeckel**

glass with airtight cover  
bote con cierre hermético  
pot en verre avec fermeture hermétique



	cm	↑ cm	ltr.
82328	12 x 12	22	2



3 ltr.

inkl. Löffel

**Vorratsglas**

canister with lid  
bote con tapa  
pot en verre avec couvercle



**Glaskugel mit Löffel, Schraubdeckel mit aromadichtem Verschluss, Edelstahl-Löffel mit magnetischem Silikongriff, 1 Stck.**

tight cover, stainless steel spoon with magnetic silicone handle, 1 pc.  
tapa a rosca con cierre hermético, cuchara de acero inoxidable con mango de silicona magnético, 1 pza  
couvercle à vis avec fermeture hermétique, cuillère en acier inox avec manche de silicone aimanté, 1 pc.

	Ø cm	↑ cm	ltr.
00636	20	18	3



1 ltr.

**Vorratsglas**

canister with lid  
bote con tapa  
pot en verre avec couvercle



**Glaskugel mit Schraubdeckel, aromadichtem Verschluss, 1 Stck.**

glass ball, aroma-tight screw cap, 1 pc.  
bote de cristal, tapa a rosca para conservar el aroma, 1 pza  
pot en verre, couvercle à vis pour conserver l'arôme, 1 pc.

	cm	↑ cm	ltr.
00637	12,5 x 19	18	1





**Bonspieß**  
bill spike  
pinchanotas  
pique-bons



Spieße aus flexiblen Kunststoff, mit stumpfen Enden zur Unfallverhütung  
spikes made of flexible plastic, with blunt ends to prevent accidents  
pinchos de plástico flexible  
piques en plastique flexible

	cm	↑ cm
88855	9 x 5,5	10,5



**Bonleiste**  
bill rail  
portafichas  
barre porte-bons



matt poliert, mit Kugel-Greifsystem, zur Wandmontage geeignet, auch mit Magneten nutzbar  
satin polished finish, small balls hold the bills, suited for wall fastening, can also be used with magnets  
acabado satinado, con sistema de bolas para colgar las notas para fijar en la pared, puede usarse con imán  
mat satiné, avec billes pour fixer sans effort tous types de fiches et papiers, peut se fixer sur plaque aimantée

	cm	↑ cm
88900	40 x 8	2
88901	50 x 8	2
88902	60 x 8	2



**Magnet-Messerhalter**  
magnetic knife rack  
barra magnética para cuchillos  
barre aimantée pour couteaux



mit 2 Magnetschienen und Haken, aus massivem Kunststoff, zur Wandmontage geeignet, Lieferung ohne Deko  
with 2 magnet racks and hooks, strong plastic, suited for wall fastening  
con 2 railes magnéticos y ganchos, plástico macizo, fijación en pared  
avec 2 rails aimantés et crochets, plastique robuste, fixation murale

	→ cm
88911	45
88912	60



**Folien-Abreißvorrichtung, mit Abreißkante / Säge**  
clingfilm tear-off dispenser  
dispensador de film  
dérouleur de film



mit Abreißkante / Säge-Messer, für Endlosfolie, als Tischgerät oder Wandgerät verwendbar  
with saw, for endless rolls, can be fixed on the wall  
con sierra para rollo de film continuo, se puede fijar en la pared  
avec lame dentée pour rouleau de film, peut être fixé au mur

	cm	↑ cm	
88288	34 x 16	9	für Folienbreite 30 cm / for film width 30 cm para film ancho 30 cm / pour film largeur 30 cm
88287	49 x 16	9	für Folienbreite 45 cm / for film width 45 cm para film ancho 45 cm / pour film largeur 45 cm



**Schneidbrettständer**  
cutting board rack  
soporte para tablas  
rack pour planches à découper



für 6 Schneidbretter bis 25 mm Stärke, Lieferung ohne Deko  
for 6 chopping boards up to 25 mm thickness  
para 6 tablas de corte de 25 mm  
pour 6 planches de 25 mm

	cm	↑ cm
88903	27 x 31	28



**Eiswaffel-Ständer**  
cornet stand  
soporte cucuruchos  
support à cornets



matt poliert, mit 4 Löchern, 2 x Ø 31 mm + 2 x Ø 26 mm  
satin polished finish, with 4 holes, 2 x Ø 31 mm + 2 x Ø 26 mm  
acero inoxidable con 4 agujeros 2 x Ø 31 mm + 2 x Ø 26 mm  
inox, 4 trous - 2 x Ø 31 mm + 2 x Ø 26 mm

	cm	↑ cm
11881	9,5 x 27,5	9



**Eiswaffel-Ständer**  
cornet stand  
soporte cucuruchos  
support à cornets



mit 4 Löchern, 2 x Ø 31 mm + 2 x Ø 26 mm  
with 4 holes, 2 x Ø 31 mm + 2 x Ø 26 mm  
con 4 agujeros, 2 x Ø 31 mm + 2 x Ø 26 mm  
4 trous, 2 x Ø 31 mm + 2 x Ø 26 mm

	cm	↑ cm
11894	24,5 x 9,5	9



**Eisportionierer**  
ice cream scoop  
cuchara para helado  
cuillère à glace



hochglanzpoliert, mit Edelstahlfeder (physikalisch bedingt nicht korrosionsbeständig)  
mirror polished finish, spring steel, spring is not stainless  
pulido brillante, muelle de acero especial, no resistente al óxido  
poli brillant, ressort acier spécial, non résistant à l'oxydation

	Ø cm	→ cm	ltr.
71006	6,5	23,5	1/12



**Quetschflasche „MINI“, 4er Set**

squeeze bottle, 4 pcs.  
bote dosificador flexible, 4 pz.  
bouteille verseuse souple, 4 pc.



mit Schraubdeckel und Verschlusskappe, ideal zum Servieren von Dressing und Saucen  
with tight-screw and cap, ideal for serving dressing and sauces  
tapa de rosca, con tapón, ideal para servir aliño y salsas  
bouchon à vis de étanche, avec bouchon, idéal pour servir de vinaigrette et sauces

	Ø cm	↑ cm	ltr.	pcs.
93225	3,0	8,5	0,03	4
93226	3,5	9,5	0,05	4



**Quetschflasche**

squeeze bottle  
bote dosificador flexible  
bouteille verseuse souple



ideale Größe, um Speiseteller mit Saucen zu verzieren, mit Verschlusskappe  
ideal size to garnish plates with sauces, with cap  
tamaño ideal para decorar los platos con salsas o culis, con tapón  
taille idéale pour la décoration sur assiette avec sauces ou coulis, avec bouchon

	Ø cm	↑ cm	ltr.
93154	5	18	0,2
93163	5,5	19	0,35



**Quetschflasche**

squeeze bottle  
bote dosificador flexible  
bouteille verseuse souple



mit Verschlusskappe  
with cap  
con tapón  
avec bouchon

	Ø cm	↑ cm	ltr.	Farbe / Colour
93155	6,5	25	0,65	
93156	6,5	25	0,65	
93157	6,5	25	0,65	



**Quetschflasche**

squeeze bottle  
bote dosificador flexible  
bouteille verseuse souple



	Ø cm	↑ cm	ltr.	Farbe / Colour
93222	9,5	25,5	1,1	
93223	9,5	25,5	1,1	
93224	9,5	25,5	1,1	



**Dosierspender**  
dispenser  
dispensador de salsa  
doseur à sauce



	cm	↑ cm	ltr.
93151	13 x 7,5	27	1,25
93150	11 x 11	27	1,35

**Dosierpumpe**  
dosing pump / riser tube  
bomba de salsa, sola  
pompe à sauce



**Hubvolumen 30 ml**  
swept volume 30 ml  
cada dosis 30 ml  
30 ml par dose

	Ø cm	↑ cm
88271	4,5	40



**Gewürzkasten**  
condiment container  
especiero  
boîte à épices ou ingrédients



**matt poliert, 4 herausnehmbare Einsatzschalen je 0,5 l, Scharnierdeckel aus Acryl**  
satin polished finish, 4 removable inserts each 0,5 ltr., acrylic lid  
acabado mate, 4 contenedores extraíbles de 0,5 L cada uno, tapa con bisagras de acrílico  
poli mat, 4 compartiments amovibles de 0,5 l chacun, couvercle rabattable en acrylique

	cm	↑ cm	ltr.
71700	31 x 15,5	9,5	4 x 0,5

**Einsatzschale / insert / contenedor 0,5 L / récipient 0,5 L**

	cm	↑ cm	ltr.
71701	14,2 x 7,5	7	0,5



**Universalbox**  
universal box  
caja dispensadora  
boît distributrice



**ideal für Zucker, Milch und Gebäck, 3 Fächer**  
best for sugar, milk and biscuits, 3 compartments  
la perfecta solución para a zúcar, leche y galletas, 3 compartimentos  
la solution idéale pour sucre, lait et biscuits, 3 compartiments

	cm	↑ cm
11886	41,5 x 20,5	16



Die Servierpfännchen aus emailiertem Gußeisen dienen dem portionsweisen Servieren und halten die Speisen warm.

The serving pans made of enamelled cast iron are used for serving in portions and for keeping the food warm.

Las fuentes de hierro fundido esmaltado se utilizan para servir en porciones y mantener la comida caliente.

Les plateaux de service en fonte émaillée sont utilisés pour servir en portions et garder les aliments au chaud.



Servierpfännchen „CAST IRON“  
serving pan  
fuente para servir  
plat de service



Gusseisen emailiert  
enamelled cast iron  
hierro fundido esmaltado  
fonte émaillée

	Ø cm	↑ cm	Farbe / Colour
88220	10	2	■
88225	10	2	■
88221	13	2	■
88226	13	2	■

	cm	↑ cm	Farbe / Colour
88222	13 x 13	2	■
88227	13 x 13	2	■
88223	16 x 13	2	■
88228	16 x 13	2	■
88224	20 x 13	2	■
88229	20 x 13	2	■



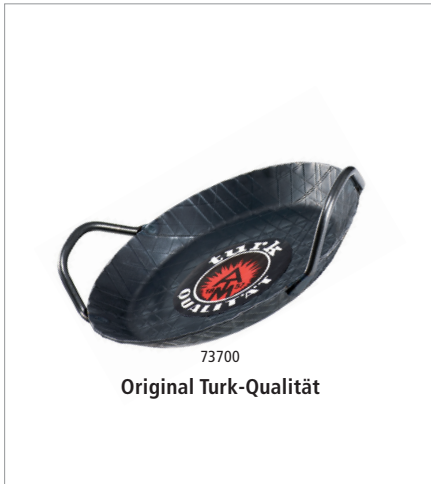

**schmiedeeiserne Servierpfanne**

pan wrought-iron  
sartén forjada  
poêle à frire forgée



mit zwei Griffen, hervorragende Brateigenschaft, Griffe und Stiele angeschweißt  
with two welded handles, best bake properties, professional quality  
con dos asas, excelentes propiedades de cocción, calidad profesional  
2 anses, qualité professionnelle, excellente diffusion de chaleur, idéale pour la cuisson

	Ø cm	↑ cm	kg
73700	14 - 20	3	0,87
73701	17 - 24	3	1,15
73702	21 - 28	3,5	1,49
73703	24 - 32	3,5	1,85



**Korkuntersetzer**

cork mat  
salvamanteles  
dessous-de-plat liège



ideal für Servier- und Eisenpfannen  
ideal for iron pan  
ideal para servir en sartenes de chapa  
idéal pour présenter les poêles forgées sur table

	Ø cm	↑ cm
73750	24	2



**schmiedeeiserne Servierpfanne**

wrought-iron pan  
sartén forjada  
poêle à frire forgée



mit geschmiedetem, angeschweißtem Hakenstiel, hervorragende Brateigenschaft  
welded handle with hook, best bake properties, professional quality  
mango soldado, con gancho al final, excelentes propiedades culinarias, calidad profesional  
manche soudé à accrocher, qualité professionnelle, excellente diffusion de chaleur, idéale pour la cuisson sur tous feux, pour le four ou pour la table

	Ø cm	↑ cm	kg
73711	14 - 20	3	0,85
73712	17 - 24	3	1,17
73713	21 - 28	3	1,53
73714	24 - 32	3	1,99



**Eisenpfanne**

iron pan  
sartén de chapa  
poêle à frire lyonnaise



schwere Ausführung, mit angeschweißtem Hakenstiel, extra hoher Rand, für den professionellen Einsatz  
heavy version, with flat welded handle with eye, extra high seam, professional quality  
pesada, con mango plano, borde alto, para uso profesional  
qualité lourde, manche plat, bord haut, pour usage professionnel

	Ø cm	↑ cm	kg
73740	17 - 24	4	1,45
73741	20,5 - 28	4,5	1,87
73742	23 - 32	5	2,41
73743	27 - 36	6	3,11



**Pizzaform**  
 pizza dish  
 molde de pizza  
 moule à pizza



Blaublech, nicht beschichtet, lange Lebensdauer, zum professionellen Pizzabacken  
 metal sheet, without coating, long endurance, baking pizza professional  
 chapa azul, sin revestimiento, muy resistente, para uso profesional, larga duración  
 métal, sans revêtement, très résistant, pour usage professionnel, très durable

	Ø cm	↑ cm
73502	18 - 16,2	2,5
73503	20 - 18,2	2,5
73504	22 - 20,2	2,5
73505	24 - 22,3	2,5
73506	26 - 24,3	2,5
73507	28 - 26,3	2,5
73508	30 - 28,3	2,5
73509	32 - 30,3	2,5
73510	36 - 34,3	2,5
73511	40 - 38,3	2,5
73513	50 - 48,4	2,5



**Pizzaform**  
 pizza dish  
 molde de pizza  
 moule à pizza



Blaublech, rechteckig, Rand umgelegt, hitzebeständig bis 260°C  
 blue steel baking sheet, rectangular  
 chapa azul rectangular, borde plgado  
 métal, rectangulaire, bord plié

	cm	↑ cm
88256	60 x 40	2,5



**Aufsteller „ACHTUNG RUTSCHGEFAHR“**  
 stand  
 letrero  
 panneau



	cm	↑ cm	Farbe / Colour
71421	30 x 63	63	<span style="background-color: yellow; border: 1px solid black; display: inline-block; width: 15px; height: 10px;"></span>







# Hauben & Zubehör

covers & accessories  
campanas & accesorios  
cloches & accessoires

# QUALITÄTSHAUBEN

11042  
GN 1/1

11041  
GN 1/2



## GN Abdeckhaube

GN cover  
GN cubierta  
GN cloche



passend für GN Tablett, glasklarer Kunststoff, nahezu unzerbrechlich  
suitable for GN trays, clear plastic, nearly unbreakable  
apto para bandejas GN, plástico transparente, muy resistente a la rotura  
pour bacs et plateaux GN, plastique transparent, très résistant à la casse

	cm	↑ cm	∅ mm	GN
11043	32,5 x 17,6	10,5	3	1/3
11044	53,0 x 16,2	10,5	3	2/4

	cm	↑ cm	∅ mm	GN
11041	32,5 x 26,5	9,5	3	1/2
11042	53,0 x 32,5	9,5	3	1/1



stapelbar  
stackable



## GN 1/1 Haube „HOCHSTAPLER“

GN 1/1 cover  
GN 1/1 campana  
GN 1/1 cloche



glasklarer Kunststoff, Tablett fixiert sich auf der Haube - kein Rutschen möglich, nahezu bruchfest  
clear plastic, tray fixes itself on the cover and can not slip off, nearly unbreakable  
plástico transparente, la bandeja se fija a la tapa para que no se deslice, muy resistente a la rotura  
en plastique transparen, le plat se fixe sur le dessous de la cloche pour ne pas glisser, très résistant à la casse

	cm	↑ cm	GN	fits to
11305	53 x 32,5	9	1/1	11300, 11290, 11295



**GN Kuppelhaube**

GN cover  
GN cúpula  
GN cloche bombée

glasklarer Kunststoff, Griff verchromt  
clear, chrome knob  
transparente, asa cromada  
transparente, anse chromée



	cm	↑ cm	GN	
11021	33 x 28	17	1/2	geschlossen / totally closed cerrada / toalemt fermée
11022	33 x 28	17	1/2	mit Front-Ausschnitt / one long side cut out gran apertura frontal grande ouverture frontale
11026	54 x 33	20	1/1	geschlossen / totally closed cerrada / toalemt fermée
11027	54 x 33	20	1/1	mit Front-Ausschnitt / one long side cut out gran apertura frontal grande ouverture frontale
11028	54 x 33	20	1/1	mit seitlichem Ausschnitt / one small side cut out pequeña apertura lateral petite ouverture latérale



stapelbar  
stackable

## Hauben & Zubehör



### GN Rolltophaube

GN rolltop cover  
GN campana rolltop  
GN cloche rolltop



patentiert, passend für GN-Behälter, -Tablets, etc., leichtgängig auf- und zuklappbar 90°  
patented, suitable for GN trays, solid quality, 90° opening  
patentada, para bandejas GN, apertura 90°  
brevetée, pour plateaux GN, ouverture 90°

	cm	↑ cm	GN	
11008	53,0 x 32,5	19	1/1	vergoldeter Griff / gold plated handle pomo dorado / bouton doré
11010	53,0 x 32,5	19	1/1	verchromter Griff / chrome plated handle pomo cromado / bouton chromé
12008	32,5 x 26,5	15	1/2	vergoldeter Griff / gold plated handle pomo dorado / bouton doré
12010	32,5 x 26,5	15	1/2	verchromter Griff / chrome plated handle pomo cromado / bouton chromé



### GN 1/1 Rolltophaube „SUNDAY“

GN 1/1 rolltop cover  
GN 1/1 campana rolltop  
GN 1/1 cloche rolltop



Griff ABS verchromt, leichtgängig auf- und zuklappbar

handle chrome plated, easy to open and close  
asa material ABS cromado, fácil de abrir y cerrar  
poignée matériel ABS chrome, ouverture et fermeture faciles

	cm	↑ cm	GN
11016	53,0 x 32,5	19	1/1



### GN 1/1 Rolltop-Haube

GN 1/1 rolltop cover  
GN 1/1 campana abatible  
GN 1/1 cloche basculante



verchromter Zinkdruckguss-Griff / chrome plated metal handle / mango cromado de fundición a presión de zinc / poignée en zinc moulé sous pression chromé

	cm	↑ cm	GN
11018	53,0 x 32,5	17	1/1



### Rolltophaube „PURE“

rolltop cover  
campana abatible  
cloche basculante



verchromter Griff / chrome plated handle / pomo cromado / bouton chromé

	cm	↑ cm
09013	44 x 33,5	17



### GN 1/1 Haube

GN 1/1 cover  
GN 1/1 campana  
GN 1/1 cloche



klappbar, passend für GN 1/1-Behälter, GN 1/1-Tablets, etc., nahezu bruchfest  
suitable for GN 1/1 chafing dish, GN 1/1 trays, GN 1/1 pans  
plegable, para cubetas GN 1/1, bandejas GN 1/1 etc., muy resistente a la rotura  
pliable, pour bacs GN 1/1, plateaux GN 1/1 etc., très résistant à la casse



klappbar  
adjustable

	cm	↑ cm	GN
11013	53,0 x 32,5	6	1/1



**Rolltophaube**  
rolltop cover  
campana abatible  
cloche basculante



glasklarer Kunststoff, leichtgängig auf- und zuklappen 90°  
solid quality, to be opened 90°  
plástico transparente, apertura 90°  
plastique transparent résistant, ouverture 90°

	Ø cm	↑ cm	
18388	38	20	mit verchromtem Kugelgriff / with chrome plated handle con pomo cromado / avec bouton chromé
18387	38	20	mit vergoldetem Kugelgriff / gold plated handle pomo dorado / bouton doré
18380	50	26	mit verchromtem Zylindergriff / chrome plated handle pomo cromado / bouton chromé



**Frischhalte-Haube**  
cover  
campana  
cloche bombée



glasklar, Griff verchromt, schwere, stabile Ausführung  
transparent, chrome knob, heavy stable quality  
transparente, asa cromada, alta estabilidad  
transparente, anse chromée, très stable

	Ø cm	↑ cm	fits to
15350	16,5	10	15130
15351	20,5	10	15131, 15141, 15136, 15271, 84241



# Hauben & Zubehör



## Frischhalte-Haube

cover  
campana  
cloche



**schwere, glasklare Qualität**  
stable, crystal clear quality  
calidad estable y transparencia cristalina  
qualité stable et clarté cristalline

	Ø cm	↑ cm	fits to
06519 <small>NEW</small>	21	17	84941, 84942
06520	30	22	85034, 84242, 84177, 83891, 83890, 83884, 15303, 998, 975, 469, 468, 463, 462 46,
06521 <small>NEW</small>	36	27	84945, 84946



**stapelbar**  
stackable



## Frischhalte-Haube

cover  
campana  
cloche



**glasklar, schwere stabile Ausführung, stapelbar**  
clear, heavy stable quality, stackable  
transparente, alta estabilidad, apilable  
transparente, très stable, empilable

	Ø cm	↑ cm	
06510	30	11,5	
06512	30	11,5	mit verchromtem Griff / with chrom plated handle con botón cromado / avec bouton chromé



## Frischhalte-Haube

cover  
campana  
cloche



**glasklar, schwere stabile Ausführung, stapelbar**  
clear, heavy stable quality, stackable  
transparente, alta estabilidad, apilable  
transparente, très stable, empilable

	Ø cm	↑ cm	
06515	33	12,5	
06517	33	12,5	mit verchromtem Griff / with chrom plated handle con botón cromado / avec bouton chromé

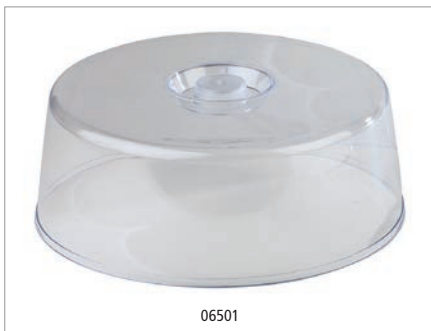

## Frischhalte-Haube

cover  
campana  
cloche



	Ø cm	↑ cm	
06501	30	11	
06504	30	9,5	
06506	30	7	



**Frischhaltehauben, 2er Set**

covers, 2 pcs. set  
campanas, set de 2  
cloches, pack de 2



	Ø cm	↑ cm
40752	30	11



**Deckel „FLOAT“ mit Löffelaussparung**

cover, with notched for spoons  
tapa, con espacio para la cuchara  
couvre-cle, avec encoche pour la louche



	Ø cm	↑ cm	fits to
83920	20,5	1,3	83908, 83909



**Deckel „FLOAT“ mit Löffelaussparung**

cover, with notched for spoons  
tapa, con espacio para la cuchara  
couvre-cle, avec encoche pour la louche



	cm	↑ cm	fits to
83921	19 x 19	1,3	83916, 83917
83922	25 x 25	1,3	83918, 83919



**Deckel „PURE“ mit Löffelaussparung**

cover with notched for spoons  
tapa con espacio para la cuchara  
couvre-cle avec encoche pour la louche



	cm	↑ cm	fits to bowls
83600	19 x 19	1,5	84410, 84417, 84422, 83409, 83572, 84468, 83573, 84429, 84244
83601	25 x 25	1,5	84408, 84418, 84423, 83469, 83574, 83575, 83408, 84430, 84245, 84561, 84562, 84563
83602	32 x 32	1,5	84425, 84427



stapelbar  
stackable



## Frischhaltedeckel

airtight cover  
tapa hermética  
couverture hermétique



mit Silikondichtung, für luftdichtes Verschließen, Lebensmittel bleiben lange frisch  
with silicone sealing ring, bowls closed airtight, to keep food fresh for a long time  
junta de silicona para cerrar herméticamente y mantener los alimentos frescos más tiempo  
joint de silicone pour fermeture hermétique et meilleure conservation des aliments

	Ø cm	fits to
10890	14	11865, 83700, 83701
10887	23	11875, 11846, 11848, 83702, 83703



zwei Öffnungspositionen des Deckels  
two opening positions of the lid

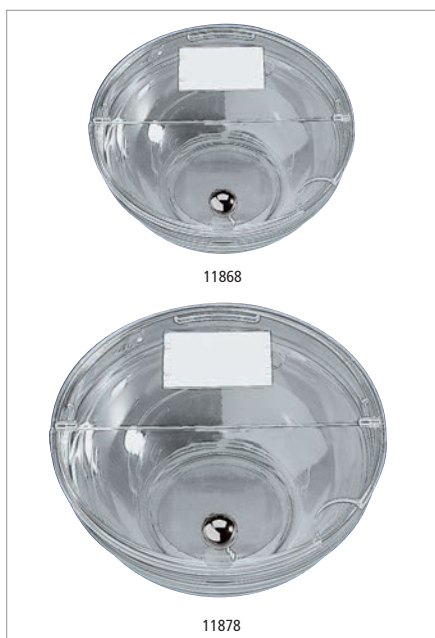

## Schutzdeckel mit Löffelaussparung

cover  
tapa  
couverture



glasklar, klappbar, mit 10 Beschriftungs-Schildern  
transparent, with 10 cards for inscription  
plástico transparente, con 10 etiquetas para inscripción  
plastique transparent, avec 10 étiquettes pour inscription

	Ø cm	
11868	14,5	mit verchromtem Griff / chrome plated handle botón cromado / bouton chromé
11878	23,5	mit verchromtem Griff / chrome plated handle botón cromado / bouton chromé

Schilder, 10er Set / signs, 10 pcs. set / set de 10 cartelitos / set de 10 étiquettes

	fits to
12879	11867, 11868
11879	11877, 11878



## Deckel klappbar mit Löffelaussparung

cover hinged  
tapa con bisagra  
couverture avec charnière



glasklar, mit Designer-Griff, verchromt, ohne Beschriftungsschild  
clear, with designer handle, chrome plated, without card for inscription  
transparente, con pomo de diseño cromado, sin tarjetas para inscripción  
transparent, avec bouton chromé de design, sans étiquette pour inscription

	Ø cm
10889	23,5



## Schale

bowl  
cuenco  
bol



	Ø cm	↑ cm	ltr.	pcs
11875	23,0	10,5	2,50	6
11865	14,0	6,5	0,50	6
11866	7,5	3,5	0,09	36
11859	6,0	2,5	0,05	36





**Kühlakku**

cooler  
 acumulador de frío  
 accumulateur de froid



gefüllt mit Kühlflüssigkeit, nicht giftig, einfach im Gefrierfach einfrieren, unbegrenzt wiederverwendbar  
 freeze it in freezer, non toxic, filled with freezer-liquid, boundless reusable  
 se enfría en el congelador, no tóxico, se puede reutilizar sin límite  
 liquide eutectique qui accumule froid une fois dans le congélateur, non toxique, réutilisable sans limites

	Ø cm	↑ cm	Farbe / Colour
10777	15	2,5	white
10781	10,5	2,5	white
10661	10,5	2,0	white
10752	10,5	2,0	black



**Kühlakku**

cooler  
 acumulador de frío  
 accumulateur de froid



gefüllt mit Kühlflüssigkeit, nicht giftig, einfach im Gefrierfach einfrieren, unbegrenzt wiederverwendbar  
 freeze it in freezer, non toxic, filled with freezer-liquid, boundless reusable  
 se enfría en el congelador, no tóxico, se puede reutilizar sin límite  
 liquide eutectique qui accumule froid une fois dans le congélateur, non toxique, réutilisable sans limites

	cm	↑ cm	Farbe / Colour
10782	41 x 21	2,5	white
10791	25 x 19	2,5	white
11101	16 x 7,5	2,0	blue



**Aufsteller „ACHTUNG RUTSCHGEFAHR“**

stand  
 letrero  
 panneau



	cm	↑ cm	Farbe / Colour
71421	30 x 63	63	yellow

# Laserlogo Individual

perfekte Lasergravuren  
perfectly Laser engravings  
grabado perfecto por láser  
marcage laser parfait



## Unverwechselbar - Einzigartig -Imagefördernd Ihre individuelle Lasergravur von APS

Wir bieten Ihnen die Möglichkeit, unsere Produkte mit Ihrem individuellen Logo per Laser zu gravieren - einzigartig, unverwechselbar und bereits ab 10 Stück je Artikel. Die perfekte Beschriftung durch modernste Lasertechnologie ist spülmaschinenfest und somit dauerhaft auf allen Edelstahl- und Naturschieferprodukten, sowie auf versilberten und verchromten Metall-Artikeln umsetzbar. Machen Sie aus Ihren Gastnorm-Behältern Ihre ganz persönlichen Unikate und werten Sie Ihre Servierartikel mit Ihrem eigenen Logo auf.

- geringe Mindestbestellmenge von nur 10 Stück
- kurze Lieferzeiten
- Logos bis zu einer Fläche von max. 10 x 10 cm realisierbar

## Distinct - Unique - Image enhancing Your individualised laser engraving by APS

We offer you the option of having your personalised logo engraved on our products - inimitable, unique, and available for delivery from only 10 pieces per product. The perfect inscription by use of the newest technology is dishwasher-safe and thus can be permanently applied to products made of stainless steel and natural slate, as well as silver-coated and chromed metal articles. Turn your gastornorm container into your individual, one of a kind article and enhance your serving items with your own logo.

- minimum order quantity of only 10 pieces
- swift delivery
- feasible logos are those with a maximum size of 10 x 10 cm

## Único, personalizado, promotor de imagen Grabado laser por APS

Podemos grabar su logo y así personalizar los productos APS a partir de mínimo 10 unidades por referencia.

Gracias a la novedosa tecnología de grabado por láser, la inscripción es perfecta y resistente al lavavajillas. Se puede aplicar a los artículos en acero inoxidable, pizarra natural, metal cromado y plateado.

- Cantidad mínima de solamente 10 unidades
- Realización rápida
- Tamaño de logos hasta máximo 10 x 10 cm





















## Unique, original, porteur d'image Marcage laser par APS

Nous pouvons graver votre logo et ainsi personnaliser les produits APS à partir de 10 pièces par référence.

Grâce à une technologie d'avant-garde de marcage par laser, l'inscription est parfaitement reproduite et résistante au lave-vaisselle. Ce type de marcage peut s'appliquer sur l'acier inoxydable, sur l'ardoise naturelle, sur le métal chromé ou argenté.

- Quantité minimum de seulement 10 unités
- Fabrication rapide
- Taille du logo jusque 10 x 10 cm

# Icon-Index / Material-Index

 <b>neuer Artikel</b> new item	 <b>spülmaschinengeeignet</b> dishwasher-proof	 <b>für Induktionsplatten</b> for induction use
 <b>niedriger Preis</b> hot price	 <b>nicht spülmaschinengeeignet</b> not dishwasher-proof	 <b>kühlbar</b> for cooling
 <b>Made in Germany</b>	 <b>abwaschbar / wasserfest</b> water-proof	 <b>doppelwandig</b> double wall
 <b>GN-Größen</b> GN norm	 <b>mikrowellengeeignet</b> microwave-proof	 <b>bruchsicher</b> shatter-proof
 <b>stapelbar</b> stackable	 <b>nicht mikrowellengeeignet</b> not microwave-proof	 <b>Eigenmontage</b> self assembly
 <b>Antirutsch-Füßchen</b> non-slip feet	 <b>keine direkte Hitze</b> not direct heat	 <b>für Lebensmittelkontakt</b> food safe
 <b>Inhaltsangabe</b> volume	 <b>nicht für Backofen</b> not for baking oven	 <b>nicht für Lebensmittelkontakt</b> non food safe

## APS - BSCI-Mitglied

APS engagiert sich für die Verbesserung von Arbeitsbedingungen. Wir sind Partner der europäischen Organisation BSCI. Die "Business Social Compliance Initiative" (BSCI) ist eine Initiative von Unternehmen zur Verbesserung der Arbeitsbedingungen in der globalen Versorgungskette.



## APS is a member of BSCI

APS is committed to the improvement of working conditions. We are a partner of the European organization BSCI. The "Business Social Compliance Initiative" is an initiative of enterprises to improve working conditions in the global supply chain.

## APS Melamin - Garantierte Qualität

APS-Melaminprodukte entsprechen den Richtlinien (EG) 1935/2004 und (EU) 10/2011 der Europäischen Kommission. Diese enthalten Bestimmungen für Materialien aus Kunststoffen, welche mit Lebensmitteln in Berührung kommen. Wir arbeiten sehr eng mit den Zertifizierungsinstitutionen Intertek und TÜV zusammen und können somit die Lebensmittelsicherheit (LFGB Regulation) der APS-Melaminartikel garantieren.

## APS Melamine - Guaranteed quality

APS melamine products comply with directives (EG) 1935/2004 and (EU) 10/2011 of the European Commission. This contain provisions for plastic materials which come into contact with foodstuffs. We work very closely together with the certification institutions Intertek and TÜV and are therefore able to guarantee the compatibility with foodstuffs (German LFGB regulation) of APS melamine.

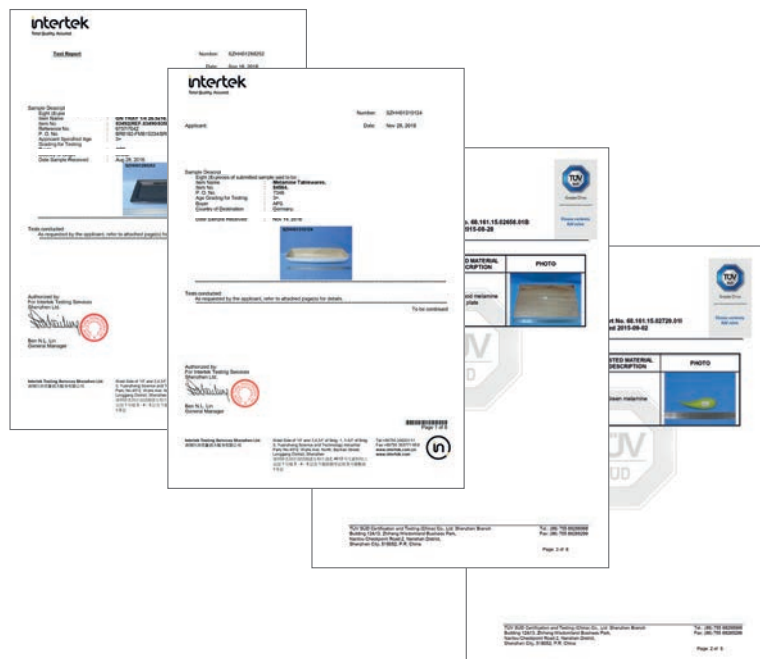

**Edelstahl 18/10 / Stainless steel 18/10**

Werkstoff 1.4301; rostfrei; langlebig; gute isolierende Eigenschaften; absolut hygienisch und nicht toxisch; recyclebar; nicht resistent gegen dauerhaften Kontakt mit Chloriden und Säuren (z. B. Kochsalz und Fruchtsäuren); sterilisierbar; Oberfläche lässt sich vielfältig polieren; nicht magnetisch; Gebrauchstemperatur bis ca. 400 °C

Pflege: pflegeleicht; maschinell oder per Hand mit milden Spülmitteln; möglichst keine Stahlwolle u. ä. verwenden; nach Erhitzung Schockabkühlung vermeiden

**Edelstahl (unspezif.) / Stainless steel (unspecific)**

niedrig nickelhaltige Edelstähle wie 14/4; nicht magnetisch; geringere allgemeine Resistenz als Edelstahl 18/10; Pflege: s. Edelstahl 18/10

**Edelstahl 18/0 / Stainless steel 18/0**

Werkstoff 1.4016; rostfrei; langlebig bei entsprechender Pflege; absolut hygienisch und nicht toxisch; gut härtbar, daher idealer Stahl für Tafelmesser, Tablett, Schneidewerkzeuge u. ä.; lässt sich hochglanzpolieren; für Nickelallergiker geeignet; magnetisch; nicht so chemikalienresistent wie Edelstahl 18/10; Gebrauchstemperatur bis ca. 400 °C

Pflege: maschinell oder per Hand mit milden Spülmitteln; Ablagerungen von Kalk und Reinigerresten nach dem Spülen unbedingt entfernen; niemals mit Stahlwolle reinigen

**Eisen / Iron**

nicht rostfrei; charakteristische, strukturierte Oberfläche mit unterschiedlichen Schattierungen; durch wiederholten Schmiedevorgang ist das Material stark verdichtet und sehr hart; langlebig bei entsprechender Pflege, Pflege: vor erstem Einsatz mit Öl und Kartoffelschalen „einbraten“; später nach jeder Reinigung einfetten; stets trocken lagern

**Gusseisen / Cast Iron**

langlebig bei entsprechender Pflege; geeignet für alle Herdarten (inkl. Induktion); speichert lange Wärme und gibt sie gleichmäßig ab; absolut hygienisch bei unbeschädigter Oberfläche; relativ schweres Material; Überhitzung fast nicht möglich; nicht schlagfest; magnetisch, Pflege: nach Gebrauch sofort mit heißem Wasser reinigen; bei Fleckenbildung mit Essig nachreinigen; niemals mit Stahlwolle reinigen; milde Spülmittel verwenden; stets trocken lagern

**Versilberter Stahl / Silver plated steel**

Edelmetallüberzug; nicht völlig säurefest; nicht über längere Zeit Sonnenlicht aussetzen

Pflege: niemals scheuernde Hilfsmittel verwenden; nur mit weichem Lappen und Spezialmitteln reinigen; keine Spülmaschinenreinigung!

**Verchromter Stahl / Chrome plated steel**

nichtedles Metall mit hartem Chromüberzug; nicht säurefest; nach Beschädigung der Chromschicht kein Schutz gegen Umwelteinflüsse

Pflege: niemals scheuernde Hilfsmittel verwenden; nur mit weichem Lappen

**Aluminium**

sehr leichtes Material; sehr gute elektrische und thermische Leitfähigkeit; korrosionsbeständig; nicht spülmaschinengeeignet; Gebrauchstemperatur bis ca. +500 °C

**Porzellan**

spülmaschinengeeignet; hitzebeständig bis ca. +220 °C

**GFK – Glasfaserverstärkter Kunststoff**

starr; nahezu unzerbrechlich; spülmaschinengeeignet; Gebrauchstemperatur bis ca. +100 °C

**ABS – Acrylnitril-Butadien-Styrol**

sehr gute Oberflächenhärte; temperaturwechselfest; spülmaschinengeeignet; Gebrauchstemperatur bis ca. +100 °C

**ACRYL – künstliches Harz**

farblos; glasartig; durchsichtig; nicht splitternd; chemisch modifiziert als Plexiglas®; wichtiger Pflegehinweis: nur handelsübliche Acrylspezialreiniger oder milde alkohol- und ammoniakfreie Reinigungsmittel verwenden; nicht spülmaschinengeeignet; Gebrauchstemperatur ca. -40 °C bis ca. +50 °C

**EVA - Ethylenvinylacetat**

weich elastisch; glänzend; abwaschbar / wasserfest

Gebrauchstemperatur bis ca. +60 °C

**MF - Melamin**

sehr hart; stoß- und kratzfest; hygienisch; säurebeständig; spülmaschinengeeignet; Gebrauchstemp. ca. -30 °C bis +70 °C

**MS - Kunststoff**

farblos; glasartig; durchsichtig; nicht spülmaschinengeeignet; Gebrauchstemperatur ca. 0 °C bis ca. +70 °C

**PA - Polyamid**

starr; bruch- und schlagfest; mattglänzend; spülmaschinengeeignet; Gebrauchstemperatur bis ca. +220 °C

**PC - Polycarbonat**

starr; nahezu unzerbrechlich; sehr stabil; formbeständig in kochendem Wasser; spülmaschinengeeignet; mikrowellengeeignet; Gebrauchstemperatur ca. -30 °C bis ca. +100 °C

**PE - Polyethylen****HDPE – hochdichtes Polyethylen**

hart elastisch; unzerbrechlich; ausreichend formbeständig in heißem Wasser; glänzend; spülmaschinengeeignet; Gebrauchstemperatur ca. -40 °C bis ca. +120 °C

**NDPE – niederdichtes Polyethylen**

weich elastisch; unzerbrechlich; kurzzeitig formbeständig in heißem Wasser; nicht glänzend; spülmaschinengeeignet; Gebrauchstemperatur ca. -40 °C bis ca. +95 °C

**PP - Polypropylen**

hart elastisch; unzerbrechlich; umweltschonend recyclebar; spülmaschinengeeignet; mikrowellengeeignet; Gebrauchstemperatur ca. -30 °C bis ca. +75 °C

**PS - Polystyrol**

starr; kratzfest; formbeständig in kochendem Wasser; nicht spülmaschinengeeignet; Gebrauchstemperatur bis ca. +70 °C

**PVC - Polyvinylchlorid**

säurebeständig; schwer entflammbar; nicht spülmaschinengeeignet; Gebrauchstemperatur ca. -50 °C bis ca. +60 °C

**SAN - Styrol-Acrylnitril**

gute Oberflächenhärte; temperaturwechselfest; spülmaschinengeeignet; Gebrauchstemperatur bis ca. +100 °C

**Silikon**

hohe thermische Beständigkeit; gute Kälteflexibilität; spülmaschinengeeignet; Gebrauchstemp. ca. -70 °C bis ca. +180 °C

**Tritan®**

starr; unzerbrechlich; absolut formbeständig; sehr hohe Chemikalienbeständigkeit; spülmaschinenfest; Gebrauchstemperatur ca. -30 °C bis ca. +95 °C; nicht mikrowellengeeignet

**Schiefer®**

Naturschiefer versiegelt; lebensmittelecht; nicht spülmaschinengeeignet;

**Beton®**

Werkstoff Beton, coole Optik; nicht spülmaschinengeeignet; handgefertigt

**Tetron**

Maschinenwaschbar bis 30 Grad, 65% Polyester, 35% Viskose



10749	6	81	11016	8	58, 532	11538	5	75	11766	2	149	11990	1	137	13987	9	27, 132
10750	2	99	11018	2	19, 20, 365, 532	11540	8	70	11767	9	149	11991	8	137	13990	9	25
10752	6	81, 537	11020	5	30	11541	5	70	11768	6	149	11994	9	143, 419	13995	4	27
10755	7	100	11021	2	58, 365, 531	11542	2	71	11775	4	141	11997	0	143, 419	14940	3	17
10756	4	100	11022	9	58, 365, 374, 531	11543	9	71	11776	1	141	11998	7	143, 301, 419	14941	0	17
10757	1	100	11023	6	29	11553	8	366	11778	5	151	11999	4	143, 301, 419	14953	3	20
10758	8	100	11024	3	29	11555	2	366	11780	8	151	12000	6	29	14954	0	20
10759	5	100	11025	0	29	11556	9	140	11781	5	150	12008	2	58, 532	14956	4	20
10760	1	95	11026	7	58, 365, 531	11557	6	59, 119	11795	2	126	12010	5	58, 532	14965	6	131
10761	8	81	11027	4	58, 354, 364, 365, 374, 531	11558	3	59, 119	11805	8	131	12040	2	30	14966	3	110
10762	5	81	11028	1	58, 365, 531	11562	0	140	11807	2	131	12050	1	130	14970	0	19
10764	9	82	11032	8	29	11563	7	140	11808	9	131, 132	12051	8	130	14980	9	26
10765	6	97	11038	0	29	11570	5	141	11810	2	77	12054	9	130	14981	6	26
10766	3	82	11040	3	30	11571	2	141	11811	9	76, 77	12055	6	130	14985	4	28
10769	4	82	11041	0	32, 190, 365, 411, 530, 531	11572	9	140	11812	6	76, 77	12065	5	30	14987	8	28, 132
10770	0	82	11042	7	32, 190, 354, 365, 374, 411, 530, 531	11573	6	140	11813	3	76, 77	12100	3	29	14990	8	25
10771	7	83	11043	4	32, 190, 365, 411, 530	11574	3	141	11815	7	77	12221	5	393	14995	3	28
10772	4	83	11044	1	21, 32, 104, 174, 190, 365, 374, 411, 530	11575	0	141	11816	4	76, 77	12222	2	393	15100	0	157
10773	1	83	11048	9	29	11576	7	141	11817	1	76	12225	3	393	15101	7	157
10774	8	83	11065	6	30	11579	8	469	11818	8	76	12228	4	396	15102	4	157
10775	5	83	11100	4	29, 74	11590	3	74	11833	1	131	12232	1	393	15103	1	157
10776	2	83	11101	1	67, 68, 73, 75, 537	11595	8	123, 124	11834	8	132	12233	8	390	15104	8	157
10777	9	26, 76, 77, 78, 87, 96, 537	11110	3	29	11596	5	124	11845	4	78	12235	2	393	15105	5	157
10778	6	133	11111	0	34	11597	2	124	11846	1	76, 77, 536	12236	9	390	15106	2	157
10781	6	537	11115	8	34	11598	9	124	11847	8	77	12240	6	390	15108	6	157
10782	3	537	11118	9	18	11599	6	124	11848	5	76, 77, 536	12243	7	396	15110	9	157
10788	5	97	11119	6	18, 239	11600	9	338	11849	2	77	12244	4	396	15111	6	157
10789	2	97	11150	9	30	11601	6	338	11859	1	136, 137, 536	12245	1	390	15112	3	157
10791	5	69, 70, 71, 72, 74, 75, 537	11155	4	30	11602	3	338	11865	2	125, 536	12249	9	389, 390	15113	0	157
10792	2	79	11156	3	31	11603	0	338	11866	9	137, 536	12260	4	390	15114	7	157
10793	9	101	11159	0	32, 409	11604	7	338	11868	3	76, 77, 125, 536	12285	7	398	15115	4	157
10794	6	101	11210	0	31	11605	4	338	11875	1	78, 124, 536	12287	1	94, 397, 398	15116	1	156
10795	3	101	11220	9	31	11606	1	112	11878	2	76, 77, 124, 536	12290	1	399	15117	8	156
10796	0	101	11244	5	396	11607	8	112	11879	9	311, 536	12291	8	387, 388, 398	15135	2	159
10797	7	101	11290	2	30, 32, 411, 530	11608	5	335	11881	2	522	12292	5	399	15136	9	159, 163, 533
10798	4	101	11295	7	31, 32, 411, 530	11609	2	335	11882	3	139	12294	9	399	15137	6	159, 163
10799	1	101	11300	8	30, 32, 411, 530	11610	8	335	11885	0	139	12295	6	383, 384, 386, 387, 388, 398	15142	0	159, 163
10800	4	95	11302	2	32, 411	11612	2	336	11886	7	140, 524	12296	3	386, 398	15165	9	159
10801	1	96	11305	3	32, 530	11613	9	336	11887	4	127	12299	4	399	15166	6	159
10803	5	96	11422	7	134	11614	6	336	11888	1	127	12300	7	389	15167	3	159
10804	2	96	11424	1	134	11615	3	336	11889	8	127	12307	6	396	15200	7	158
10805	9	98	11426	5	134	11616	0	23	11891	1	127	12310	6	396	15201	4	158
10806	6	98	11427	2	134	11617	7	23	11892	8	127	12322	9	382	15204	5	158
10807	3	96	11432	6	134	11620	7	22, 23, 24	11893	5	126	12323	6	382	15205	2	158
10808	0	96	11433	3	134	11621	4	22, 23	11894	2	522	12324	3	383	15215	1	158
10809	7	96	11434	0	134	11622	1	22, 111	11899	7	395	12325	0	383	15216	8	158
10810	3	101	11435	7	134	11623	8	22	11901	7	395	12350	2	389	15217	5	158
10812	7	96	11437	4	134	11625	2	340	11903	1	394	12352	6	385	15218	2	158
10814	1	96	11438	8	134	11626	9	22, 23	11906	2	394	12353	3	385	15219	9	158
10820	2	95	11439	5	134	11627	6	22, 23, 24, 93	11907	9	394	12354	0	385	15220	5	158
10825	7	100	11442	1	134	11628	3	22	11909	7	394	12355	7	392	15225	0	161
10830	1	99	11424	1	134	11629	0	22	11910	9	395	12356	4	392	15226	7	161
10833	2	99	11426	5	134	11630	6	337	11911	6	395	12357	1	392	15227	4	161
10835	6	100	11427	2	134	11631	3	151, 337	11912	3	395	12360	1	392	15228	1	161
10840	0	100	11428	1	134	11632	0	337	11913	0	395	12366	3	385, 388	15230	4	158
10850	9	100	11429	5	134	11633	7	151, 337	11915	4	394	12370	0	385	15231	1	158
10851	6	90, 91, 93	11431	9	134	11634	4	111, 336	11916	1	394	12371	7	385	15232	8	158
10853	0	93	11432	6	134	11635	1	338	11917	8	394	12372	4	385	15233	5	158
10855	4	93, 97	11433	3	134	11636	8	338	11921	5	148, 304, 422	12385	4	388	15234	2	158
10859	2	100	11434	0	134	11637	5	338	11922	2	148, 304, 422	12386	1	386	15235	9	158
10860	8	98	11435	7	134	11638	2	338	11930	7	146, 299	12390	8	388	15250	2	160, 161
10862	2	98	11437	4	134	11639	9	338	11931	4	146, 299	12391	5	386	15251	9	160
10864	6	98	11438	8	134	11640	5	338	11935	2	144, 300, 420	12393	9	388	15252	6	160, 161
10865	3	98	11439	5	134	11647	4	341	11936	9	144, 300, 420	12394	6	386	15253	3	160
10867	7	96, 98	11442	1	134	11648	1	341	11937	6	144, 300, 420	12396	0	387	15300	4	162, 163
10870	7	27, 99	11443	6	134	11649	8	339	11938	3	144, 300, 421	12397	7	385, 387	15301	1	162, 163
10871	4	27, 99	11444	9	135	11650	4	340	11939	0	144, 300, 420	12398	4	387	15302	8	162, 163
10872	1	28, 99	11446	3	135	11651	1	340	11940	6	423	12399	1	387	15303	5	162, 163, 216, 534
10873	8	28, 99	11447	4	135	11653	5	109	11941	3	422, 516, 526	12403	2	386	15310	3	162
10887	5	26, 536	11449	4	135	11654	2	110	11942	0	422, 516, 526	12415	8	107	15311	0	160, 162, 163
10889	9	536	11451	7	136	11660	3	109	11943	7	422, 516, 526	12483	7	389	15312	7	162
10890	5	26, 536	11455	5	136	11661	0	110	11945	1	417	12484	4	389	15313	4	160, 162, 163
10907	0	96, 100	11456	2	136	11667	2	94, 397	11946	8	417	12879	8	311, 536	15320	2	161, 378
10910	0	103	11466	1	126, 147, 418	11671	9	94, 397	11947	5	417	12940	5	17	15321	9	378
10911	7	103	11467	8	126, 147, 418	11672	6	94, 397, 398	11950	5	423	12941	2	17	15322	6	160, 161, 378
10912	4	103	11495	1	122, 125	11675	7	391	11955	0	27, 28, 142, 418	12990	0	455	15323	3	378
10913	1	102	11496	8	125	11678	8	391	11960	4	142, 418	13122	4	37	15324	0	161, 378
10914	8	102	11497	5	125	11683	2										

15401	8	168	15509	1	166, 173, 377	30114	6	43, 472	33214	0	115	36056	3	432	40245	4	361
15402	5	168	15510	7	173, 377	30115	3	42, 473	33215	7	116	36057	0	431	40246	1	362
15403	2	168	15511	4	172, 173, 377	30116	0	42, 473	33216	4	115, 169	36062	4	433	40247	8	361
15404	9	167, 168	15512	1	172, 173, 377	30117	7	42, 473	33217	1	115, 169	36063	1	433	40248	5	362
15405	6	168	15513	8	107, 167, 169, 173	30118	4	43, 472	33219	5	116	36066	2	427	40249	2	361
15406	3	168				30119	1	43, 472	33220	1	116	36068	6	428	40250	8	362
15407	0	168	15514	5	107, 172, 173	30120	7	43, 249	33221	8	366	36069	3	428	40260	7	362
15408	7	168	15515	2	107, 165, 172, 173	30121	4	43, 249	33222	5	120	36074	7	432	40262	1	362, 366
15409	4	168				30123	8	42, 473	33225	6	115	36075	4	434	40263	8	362
15410	0	168	15516	9	107, 165, 173	30126	9	473	33226	3	120	36077	8	430	40264	5	362
15411	7	168	15517	6	107, 165, 173	30130	6	44, 269, 471, 516	33227	0	120	36081	5	428	40266	9	362
15412	4	168	15518	3	107, 165, 173				33228	7	120	36082	2	431	40268	3	362
15413	1	168	15519	0	107, 165, 173	30131	3	44, 269, 471, 516	33231	7	118	36083	9	434	40270	6	362
15414	8	168	15520	6	107, 165, 173				33232	4	111, 367	36087	7	431	40272	0	362, 366
15415	5	168	15521	3	107, 165, 173	30132	0	44, 269, 471, 516	33235	5	116	36090	7	434	40274	4	362
15416	2	168	15522	0	107, 165, 173				33238	6	118	36092	1	426	40276	8	362
15417	9	168	15523	7	164, 165	30133	7	44, 269, 471, 516	33240	9	116	36093	8	426	40278	2	362
15418	6	168	15524	4	164, 165				33241	6	121	36095	2	429	40280	5	362
15419	3	168	15525	1	164, 165	30200	6	375	33242	3	121	36096	9	429	40290	4	19, 123
15420	9	168	15526	8	164, 165	30205	1	375	33243	0	119	36099	0	434	40291	1	123, 361
15421	6	168, 172	15530	5	165	30206	8	375	33246	1	282	36100	3	84, 429	40292	8	19, 361
15422	3	168, 172, 377	15531	2	165, 172	30207	5	376	33247	8	282	36101	0	84, 429	40293	5	19, 361
15423	0	168	15532	9	165	30208	2	376	33248	5	118	36111	9	84, 429	40294	2	19, 365
15424	7	169	15533	6	165	30210	5	375	33249	2	105	36112	6	84, 429	40295	9	19, 364
15425	4	169	15534	3	165	30220	4	375	33250	8	105	36233	8	297	40296	6	357
15426	1	169	15535	0	165	30230	3	375	33251	5	105	36323	6	297	40297	3	357
15427	8	169	15600	5	155	30240	2	375	33252	2	105	38202	2	34	40299	7	372
15428	5	169	15601	2	104, 155, 174	30250	1	375	33255	3	14, 15, 106	<b>4</b>			40300	0	329
15429	2	169	15602	9	154, 155	30260	0	518	33256	0	14, 15, 106	40007	8	299, 368, 421	40310	9	325
15430	8	169	15603	6	154, 155	30263	1	524	33260	7	105	40009	2	299, 368, 421	40311	6	325
15431	5	169	15604	3	154, 155	30266	2	524	33261	4	105	40010	8	299, 368, 421	40312	3	325
15432	2	169	15605	0	155	30270	9	375	33262	1	105	40011	5	299, 368, 421	40313	0	325
15433	9	169, 172, 377	15606	7	155	30276	1	376	33269	0	105	40012	2	299, 368, 421	40320	8	325
15434	6	169	15607	4	155	30277	8	376	33270	6	105	40013	9	299, 368, 421	40330	7	328
15435	3	169	15608	1	155	30279	2	369	33271	3	105	40110	5	34, 376	40331	4	328
15436	0	169	15609	8	155	30280	8	369	33272	0	106	40115	0	34, 376	40403	8	339
15437	7	169	15610	4	104, 154, 174	30281	5	369	33273	7	106	40129	7	364	40404	5	339
15438	4	169	15611	1	104, 154, 174	30282	2	369	33280	5	106	40130	3	299, 368, 421	40405	2	339
15439	1	167	15612	8	154	30283	9	369	33281	2	106	40131	0	299, 368, 421	40410	6	324
15440	7	167	15613	5	154	30284	6	369	33285	0	111	40132	7	363	40411	3	324
15441	4	167	15614	2	154	30285	3	369	33286	7	111	40135	8	363	40412	0	324
15442	1	167	15615	9	154	30286	0	366, 369	33290	4	45, 117, 293	40137	2	363	40413	7	324
15443	8	167	15620	3	21, 104, 154, 155, 174	30287	7	369	33291	1	45, 117, 293	40139	6	363	40414	4	330
15444	5	167				30288	4	366, 369	33292	8	45, 117, 293	40140	2	363	40415	1	325
15445	2	167	15621	0	21, 104, 155, 174	30299	0	372	33293	5	45, 117, 293	40144	0	111, 363, 367	40424	3	328
15446	9	167				30310	2	376	33294	2	45, 117, 293	40148	8	363	40425	0	310
15447	6	167	15622	7	21, 104, 155, 174	30320	1	376	33295	9	45, 117, 293	40149	5	364	40435	9	323
15448	3	167				30325	6	113	33296	6	45, 117, 293	40150	1	365	40436	6	323
15449	0	166	15623	4	21, 104, 155, 174, 271	30332	4	428	33297	3	45, 117, 293	40152	5	363	40437	3	323
15450	6	166, 170, 172				30333	1	435	34247	7	118, 238	40153	2	364	40438	0	323
15451	3	166	15921	1	294, 334	30340	9	372	34248	4	118, 238	40159	4	363, 366	40439	7	323
15452	0	166, 170	15925	9	294, 334	30341	6	372	35050	2	391	40179	2	367	40440	3	325
15453	7	166	15926	6	294, 334	30345	4	371	35065	6	391	40182	2	367	40441	0	325
15454	4	166	17910	3	18	30346	1	371	35343	5	391	40185	3	276	40442	7	323
15455	1	166	17922	6	18	30347	8	371	35350	3	294	40186	0	42, 276	40443	4	329
15456	8	166, 170, 172, 377	18380	3	59, 533	30348	5	371	35711	2	298	40187	7	42, 276	40445	8	329
			18387	2	71, 364, 533	30350	8	372	35720	4	297	40188	4	42, 276	40446	5	329
			18388	9	71, 73, 75, 163, 257, 364, 533	30351	5	372	35730	3	297	40189	1	376	40450	2	325
15457	5	166				30355	3	339, 371	35734	1	297	40190	7	376	40453	3	328
15458	2	166, 170, 172	18389	6	19, 364	30356	0	339, 371	35735	8	297	40191	4	363	40454	0	328
15459	9	166, 172	<b>2</b>			30360	7	372	35912	3	298	40192	1	363	40455	7	326
15460	5	166, 170	23642	4	38	30361	4	372	36003	7	426	40193	8	363	40457	1	326
15461	2	171	24330	9	113	30370	6	372	36004	4	426	40194	5	363	40458	8	326
15462	9	169, 171	24331	6	113	30371	3	372	36010	5	443	40195	2	363	40460	1	326
15467	4	171	24332	3	113	30380	5	372	36011	2	443	40196	9	363	40461	8	326, 327
15468	1	170, 171	24334	7	113	30385	0	372	36013	6	453	40198	3	367	40462	5	326, 327
15473	5	170, 171	24335	4	113	30390	4	372	36015	0	453	40200	3	295	40463	2	326
15474	2	170, 171	24336	1	113	30410	9	374	36017	4	455	40201	0	295	40464	9	326
15475	9	171	24338	5	113	30411	6	374	36020	4	427	40202	7	295	40470	0	327
15476	6	171	24339	2	113	30412	3	374	36021	1	427	40203	4	295	40472	4	327
15477	3	170, 171	<b>3</b>			30413	0	374	36022	8	453	40204	1	295	40474	8	327
15478	0	171	30000	2	14, 15	30414	7	374	36024	2	453	40205	8	295	40475	5	305
15479	7	170, 171	30001	9	14, 15	30415	4	374	36025	9	426	40206	5	295	40476	2	327
15480	3	171	30002	6	14, 15	30416	1	374	36026	6	427	40207	2	295	40478	6	327
15483	4	171	30020	0	16	30440	6	370	36027	3	453	40208	9	295	40480	9	327
15484	1	171	30021	7	16	30441	3	370	36028	0	426, 428	40210	2	368	40482	3	328
15485	8	171	30043	9	66	30442	0	370	36029	7	453	40211	9	368	40485	4	329
15486	5	170, 171	30045	3	514	30443	7	370	36030	3	432	40212	6	368	40486	1	332, 466
15487	2	171	30														

40511	0	330			50906	1	355	71474	8	311	75909	1	493	81910	8	404	
40520	2	318	40686	5	276	50907	8	355	71480	9	311	75910	7	491	81911	5	404
40521	9	318	40690	2	277, 373	50908	5	355	71482	3	311	75911	4	491	81996	2	405
40522	6	318	40691	9	277, 373	50910	8	355	71483	0	311	75912	1	493	81997	9	405
40524	0	318	40692	6	277, 373	50911	5	355	71487	8	310	77315	8	470, 510	81998	6	405
40530	1	318, 319	40693	3	277, 373	50912	2	355	71489	2	310	77338	7	513	81999	3	405
40531	8	318, 319	40694	0	277, 373	50913	9	355	71490	8	312	77350	9	518	82001	2	406
40532	5	318	40695	7	277, 373	50915	3	356	71491	5	312	77352	3	518	82003	6	406
40534	9	318	40752	7	535	50916	0	356	71492	2	308	79553	2	59, 119	82004	3	406
40535	6	317	<b>5</b>			50917	7	356	71493	9	308	<b>8</b>			82005	0	406
40536	3	318	50002	0	59	50918	4	356	71494	6	308	80023	6	405	82006	7	406
40537	0	317	50100	3	358	<b>6</b>			71495	3	310	80024	3	405	82007	4	406
40538	7	316	50105	8	358	60002	7	349	71496	0	305	80025	0	405	82008	1	406
40539	4	316	50110	2	358	60012	6	349	71497	7	305	80026	7	405	82010	4	406
40540	0	317	50205	5	358	60014	0	349	71498	4	310	80027	4	405	82012	8	406
40541	7	317	50210	9	358	60015	7	349	71499	1	310	80028	1	405	82013	5	406
40544	8	319	50215	4	358	60016	4	349	71510	3	306	80029	8	405	82014	2	406
40545	5	319	50300	7	358	60018	8	349	71511	0	306	81000	6	403	82016	6	406
40546	2	317	50305	2	358	60019	5	349	71512	7	306	81095	2	403	82017	3	406
40547	9	318	50310	6	358	60020	1	351	71513	4	306	81100	3	403	82018	0	406
40548	6	317	50315	1	358	60022	5	351	71514	1	306	81101	0	403	82019	7	406
40549	3	314	50400	4	358	60023	2	351	71515	8	306	81102	7	403	82020	3	406
40550	9	314	50500	1	357	60024	9	351	71516	5	306	81104	1	403	82022	7	406
40551	6	314	50501	8	357	60037	9	347	71517	2	306	81106	5	403	82023	4	406
40552	3	314	50510	0	357	60038	6	347	71518	9	306	81108	9	403	82028	9	406
40553	0	315	50600	8	359	60040	9	347	71520	2	305	81109	6	403	82029	6	406
40554	7	315	50601	5	359	60041	6	349	71700	8	524	81116	4	400	82030	2	406
40555	4	315	50602	2	359	60042	3	349	71701	5	524	81117	1	405	82032	6	406
40556	1	315	50603	9	359	60044	7	348	73502	6	527	81118	8	405	82034	0	406
40557	8	316	50605	3	359	60045	4	348	73503	3	527	81191	1	404	82036	4	406
40558	5	316	50606	0	359	60046	1	348	73504	0	527	81195	9	404	82037	1	406
40559	2	317	50607	7	359	60270	0	35	73505	7	527	81198	0	408	82038	8	406
40560	8	317	50608	4	359	60310	3	35	73506	4	527	81199	7	408	82040	1	406
40600	1	56, 272	50610	7	359	60502	2	347	73507	1	527	81200	0	403	82042	5	406
40601	8	272	50611	4	359	60503	9	347	73508	8	527	81201	7	403	82050	0	406
40602	5	273	50612	1	359	60505	3	347	73509	5	527	81202	4	403	82051	7	406
40603	2	273	50613	8	359	60506	0	350	73510	1	527	81204	8	403	82059	3	406
40604	9	277, 373	50620	6	360	60507	7	350	73511	8	527	81206	2	403	82100	2	409
40605	6	274	50621	3	360	60508	4	350	73513	2	527	81208	6	403	82101	9	407
40606	3	274	50622	0	360	60509	1	349	73700	6	526	81209	3	403	82104	0	407
40607	0	274	50623	7	360	60510	7	350	73701	3	526	81292	5	404	82106	4	407
40610	0	272	50624	4	360	60511	4	350	73702	0	526	81295	6	404	82108	8	407
40611	7	272	50625	1	360	60512	1	349	73703	7	526	81296	3	408	82110	1	407
40612	4	273	50626	8	360	60520	6	349	73711	2	526	81300	7	403	82112	5	407
40613	1	273	50627	5	360	60521	3	349	73712	9	526	81302	1	403	82113	2	407
40616	2	274	50628	2	360	60522	0	349	73713	6	526	81304	5	403	82114	9	407
40617	9	274	50629	9	360	60523	7	349	73714	3	526	81306	9	403	82116	3	407
40618	6	274	50630	5	360	60524	4	349	73740	2	526	81308	3	403	82117	0	407
40620	9	272	50631	2	360	60525	1	348	73741	9	526	81391	5	404	82118	7	407
40621	6	272	50632	9	360	60526	8	348	73742	6	526	81395	3	404	82119	4	407
40622	3	273	50633	6	360	60527	5	348	73743	3	526	81400	4	403	82120	0	407
40623	0	273	50634	3	360	60528	2	348	73750	1	526	81401	1	403	82122	4	407
40630	8	272, 274	50635	0	360	60530	5	350	74201	7	510	81402	8	403	82123	1	407
40631	5	274	50640	4	354	60531	2	350	74207	9	35	81404	2	403	82128	6	407
40632	2	279	50641	1	354	60532	9	350	74402	8	512	81406	6	403	82129	3	407
40633	9	279	50642	8	354	60533	6	350	74403	5	512	81408	0	403	82130	9	407
40634	6	279	50643	5	354	60534	3	350	74404	2	512	81492	9	404	82132	3	407
40635	3	279	50644	2	354	60535	0	348	74700	5	511	81495	0	404	82134	7	407
40636	0	279	50645	9	354	60536	7	348	74701	2	511	81502	5	403	82136	1	407
40637	7	279	50700	5	356	60537	4	348	74702	9	511	81504	9	403	82137	8	407
40638	4	279	50701	2	356	60540	4	350	74703	6	511	81506	3	403	82138	5	407
40640	7	272, 275	50702	9	356	60541	1	350	74705	0	511	81591	9	404	82140	8	407
40642	1	296	50703	6	356	60542	8	349	74706	7	511	81595	7	404	82142	2	407
40643	8	296	50705	0	356	60550	3	351	74721	0	511	81602	2	403	82150	7	407
40644	5	296	50706	7	356	60551	0	351	74722	7	511	81604	6	403	82151	4	407
40645	2	279	50707	4	356	60552	7	351	74731	9	513	81606	0	403	82159	0	407
40646	9	279	50708	1	356	60554	1	351	74750	0	85, 470	81608	4	403	82200	9	409
40647	6	279	50710	4	355	61190	0	35	75001	2	294	81692	3	404	82201	6	61, 409
40655	1	44, 269, 276, 471	50711	1	355	61280	8	35	75002	9	294	81695	4	404	82202	3	61, 409
40656	8	44, 269, 276, 471	50712	8	355	61400	0	35	75600	7	500	81700	5	403	82203	0	61, 409
40657	5	276	50713	5	355	<b>7</b>			75800	1	499	81701	2	403	82204	7	61, 409
40658	2	276	50714	2	355	71001	6	500	75801	8	496	81702	9	403	82205	4	61, 409
40660	5	275	50720	3	356	71002	3	500	75803	2	500	81704	3	403	82210	8	383, 388
40661	2	278	50721	0	356	71003	0	500	75804	9	500	81706	7	403	82215	3	383, 388
40662	9	278	50722	7	356	71004	7	500	75805	6	456	81707	4	403	82250	4	138, 519
40663	6	278	50723	4	356	71005	4	500	75806	3	499	81791	3	404	82251	1	138, 519
40664	3	278	50800	2	359	71006	1	500	75807	0	499	81795	1	404	82252	8	138, 519
40665	0	278	50801	9	359	71400	7	483, 510	75808	7	497	81796	8	408	82253	5	138, 519
40666	7	278	50802	6	359	71421	2	527, 537	75809	4	497	81800	2	403	82255	9	138, 519
40667	4	278, 334	50803	3	359	71425	0	312	75810	0	496	81801	9	403	82256	6	138, 519
40668	1	278, 334	50805	7	359	71426	7	312	75820	9	497	81802	6	403	82257	3	138, 519
40669	8	278	50806	4	359	71427	4	312	75821	6	497	81804	0	403	82300	6	



82316	7	340 50, 51, 281, 283, 284, 288, 289, 341	83570	2	246	83770	6	411	83926	7	243	84174	1	225	84367	7	207
82318	1	283	83571	9	246	83772	0	411	83928	1	226	84177	2	209, 216, 534	84377	6	207
82319	8	283	83572	6	246, 247, 535	83773	7	411	83929	8	226	84178	9	209	84378	3	207
82328	0	131, 139, 520	83573	3	246, 247, 535	83777	5	254	83932	8	229	84179	6	209	84379	0	207
82338	9	283	83574	0	246, 247, 535	83779	9	237	83933	5	229	84180	2	219	84380	6	207
82345	7	281, 283	83575	7	246, 247, 535	83780	5	254	83934	2	229	84181	9	219	84381	3	207
82346	4	281, 283	83587	0	238	83781	2	254	83935	9	229	84182	6	219	84387	5	237
82347	1	281, 283	83588	7	244	83782	9	254	83940	3	230	84183	3	219	84400	1	193
82355	6	18, 61, 409	83589	4	244	83783	6	254	83941	0	230	84184	0	219	84401	8	193
82356	3	18, 61, 409	83592	4	244	83784	3	254	83946	5	229	84185	7	24, 60, 219	84402	5	193
82357	0	18, 61, 409	83593	1	244	83785	0	237	83947	2	229	84186	4	24, 60, 219	84403	2	193
82359	4	281	83594	8	244	83786	7	237	83948	9	229	84187	1	24, 60, 219	84404	9	193
82370	9	281	83597	9	244	83787	4	237	83949	6	229	84188	8	24, 60, 219	84408	7	247, 535
82371	6	281	83598	6	244	83788	1	237	83955	7	214	84189	5	24, 60, 219	84409	4	247
82394	5	283	83599	3	244	83789	8	237	83956	4	214	84195	6	24, 60, 219	84410	0	247, 535
82395	2	283	83600	6	215, 247, 535	83790	4	237	83957	1	214	84196	3	24, 60, 219	84414	8	247, 249
82419	5	422	83601	3	204, 215, 247, 535	83798	0	245	83958	8	214	84197	0	24, 60, 219	84415	5	247, 249
82420	1	422	83602	0	247, 535	83799	7	237	83960	1	240	84198	7	24, 60, 219	84416	2	247
83309	8	66	83610	5	480	83800	0	236	83961	8	241	84199	4	24, 60, 219	84417	9	247, 535
83310	4	66	83611	2	480	83801	7	259, 400	83962	5	240	84200	7	238	84418	6	247, 535
83311	1	65, 66	83612	9	480	83803	1	259, 400	83963	2	240	84202	1	238	84420	9	247, 249
83400	2	245	83613	6	480	83808	6	236	83964	9	240	84205	2	211	84421	6	247
83401	9	244	83614	3	480	83810	9	236	83965	6	240	84206	9	211	84422	3	247, 535
83402	6	245	83615	0	128, 379	83812	3	236	83966	3	241	84207	6	211	84423	0	247, 535
83403	3	245	83616	7	480	83814	7	236	83967	0	240	84208	3	211	84424	7	246
83404	0	245	83620	4	481	83816	1	236	83971	7	214	84209	0	211	84425	4	246, 247, 535
83405	7	245	83621	1	481	83818	5	236	83980	9	214	84215	1	255	84426	1	246
83406	4	245	83625	9	235, 245	83820	8	236	83981	6	214	84216	8	255	84427	8	246, 247, 535
83407	1	245	83629	6	235	83826	0	236	83992	2	215	84217	5	234, 265	84431	5	208
83408	8	246, 247, 535	83639	6	235	83828	4	236, 239	83994	6	215	84218	2	234, 265	84432	2	208
83409	5	111, 246, 247, 535	83640	2	235	83830	7	236	83999	1	146, 304	84220	5	255	84433	9	208
83410	1	246	83642	6	235	83832	1	236	84017	1	265	84221	2	255	84434	6	208
83411	8	249	83643	3	235	83834	5	236	84018	8	265	84222	9	255	84435	3	208
83412	5	249	83648	8	235	83842	0	261	84022	5	231	84229	8	232	84440	7	248
83414	9	246, 248, 249	83649	5	235	83843	7	261	84023	2	231	84230	4	232	84441	4	248
83415	6	246	83651	8	235	83844	7	261	84024	9	231	84231	1	232	84444	5	264
83417	0	50, 120, 245	83652	5	235	83847	5	145, 303	84025	6	231	84232	8	232	84445	2	264
83418	7	120, 245	83654	9	235	83848	2	259	84039	3	319	84233	5	232	84446	9	265
83419	4	246, 248	83655	6	235	83851	2	259	84040	9	258	84234	2	232	84448	3	264
83424	8	261	83696	9	78, 254	83862	8	250	84041	6	258	84235	9	255	84449	0	264
83426	2	261	83697	6	78, 254	83864	2	250	84042	3	258	84236	6	255	84450	6	265
83433	0	50, 244	83698	3	78, 254	83865	9	251	84043	0	258	84241	0	216, 533	84452	0	265
83434	7	244	83699	0	78, 254	83867	3	65, 66, 111	84045	4	62, 474	84242	7	216, 534	84454	4	265
83435	4	251	83700	3	78, 254	83868	0	66	84046	1	18, 61, 249	84244	1	215, 247, 535	84456	8	265
83437	8	251	83701	0	78, 254	83869	7	245, 257	84047	8	18, 20, 61, 249	84245	8	215, 247, 535	84458	2	265
83438	5	251	83702	7	78, 254	83875	8	251	84048	5	18, 61, 249	84246	5	218	84460	5	265
83440	8	251	83703	4	78, 254	83876	5	251	84080	5	250	84247	2	218	84462	9	237
83441	5	251	83704	1	78, 254	83877	2	251	84082	9	250	84248	9	218	84464	3	237
83443	9	246, 248, 249	83705	8	78, 254	83878	9	239	84083	6	250	84251	9	43, 472	84466	7	237
83444	5	251	83710	2	226	83879	6	239	84085	0	250	84253	3	43, 472	84470	4	206
83445	2	246	83712	6	226	83880	2	136, 137, 254	84086	7	250	84256	4	213	84471	1	206
83447	7	251	83714	0	227	83881	9	137, 254	84088	1	250	84257	1	217	84472	8	206
83449	1	251	83716	4	227	83882	6	244	84100	0	221	84258	8	217	84473	5	206
83450	7	246	83718	8	228	83884	0	216, 245, 534	84101	7	221	84259	5	217	84474	2	206
83451	4	246	83720	1	228	83886	4	245	84103	1	221	84260	1	232	84475	9	206
83452	1	246	83721	8	228	83887	1	261	84104	8	221	84261	8	232	84476	6	206
83453	8	246	83722	5	228	83888	8	261	84105	5	221	84262	5	210	84478	0	206
83454	5	246	83723	2	228	83889	5	261	84106	2	221	84263	2	210	84479	7	206
83455	2	246	83724	9	228	83890	1	48, 216, 257, 291, 534	84107	9	222	84264	9	210	84481	0	206
83456	9	246	83725	6	227	83891	8	48, 216, 257, 291, 534	84108	6	222	84265	6	210	84482	7	206
83457	6	246	83726	3	228	83892	5	48, 257, 291	84109	3	222	84266	3	213	84484	1	206
83466	8	246, 249	83727	0	227	83893	2	48, 257, 291	84110	9	223	84267	0	213	84490	2	253
83467	5	246	83728	7	228	83894	9	251	84111	6	223	84268	7	213	84491	9	253
83468	2	246, 247	83729	4	228	83896	3	251	84112	3	223	84269	4	213	84492	6	253
83469	9	246, 247, 535	83730	0	228	83897	0	259, 400	84113	0	223	84295	3	255	84493	3	253
83479	8	244	83732	4	228	83900	7	242	84114	7	223	84300	4	410	84494	0	253
83480	4	50, 244	83734	8	230	83901	4	242	84115	4	223	84301	1	410	84509	1	188
83481	1	244	83735	5	227	83902	1	242	84116	1	223	84302	8	410	84510	7	188
83482	8	244	83736	2	230	83903	8	242	84117	8	223	84303	5	410	84511	4	188
83483	5	245	83737	3	227	83904	5	242	84118	5	223	84304	2	122, 410	84512	1	188
83484	2	245	83738	6	230	83905	2	242	84119	2	223	84305	9	122, 410	84514	5	188
83486	6	261	83739	3	227	83906	9	242	84124	6	233	84306	6	410	84515	2	188
83487	3	261	83740	9	230	83907	6	242	84125	3	233	84307	3	410	84517	6	188
83488	0	480	83744	7	230	83908	3	242, 243, 535	84126	0	233	84308	0	410	84519	0	190
83489	7	480	83748	5	122, 410	83909	0	242, 243, 535	84127	7	233	84309	7	410	84520	6	190
83490	3	244	83749	2	122, 410	83910	6	243	84128	4	233, 260	84310	3	122, 410	84521	3	190
83491	0	244	83750	8	410	83911	3	243	84130	7	234	84311	0	122, 410	84522	0	190
83492	7	244	83751	5	410	83912	0	239, 243	84131	4	234	84327	1	191	84523	7	188, 189</

84561	9	204, 535	84724	8	208	84863	4	65, 66	85033	0	48, 183, 291	88855	5	521	93212	8	443
84562	6	204, 535	84725	5	184	84875	7	220	85034	7	48, 183, 291, 534	88900	2	521	93214	2	482, 518
84563	3	205, 535	84726	2	184	84876	4	220				88901	9	521	93220	3	454
84564	0	203	84727	9	184	84880	1	187	85035	4	48, 183, 291	88902	6	521	93222	7	523
84565	7	203	84728	6	222	84881	8	187	85040	8	258	88903	3	522	93223	4	523
84566	4	205	84729	3	222	84882	5	187	85041	5	258	88911	8	521	93224	1	523
84567	1	194	84730	9	222	84883	2	187	85042	2	258	88912	5	521	93225	8	523
84568	8	194	84731	6	222	84884	9	187	85043	9	258	88920	0	506	93226	5	523
84569	5	195	84732	3	222	84885	6	187	85044	6	257, 291	88921	7	506	93230	2	84, 454
84570	1	195	84733	0	222	84886	3	187	85045	3	257, 291	88922	4	506	93300	2	449
84571	8	194, 195	84740	8	185	84890	0	213	85046	0	48, 216, 291	88923	1	506	93301	9	464
84572	5	195	84741	5	185	84891	7	213	85047	7	48, 216, 291	88928	6	506	93302	6	464
84573	2	195	84742	2	185	84892	4	213	85048	4	48, 216, 291	88929	3	508	93303	3	458
84574	9	195	84743	9	185	84893	1	212	85049	1	46, 58, 256, 292	88930	9	508	93304	0	458
84575	6	194	84744	6	185	84894	8	212				88932	3	506	93306	4	451
84576	3	194	84745	3	185	84895	5	212	85050	7	46, 58, 256, 292	88933	0	506	93307	1	451
84577	0	195	84746	0	185	84900	6	224				88935	4	507	93308	8	330, 461
84578	7	195	84747	7	185	84901	3	224	85051	4	46, 58, 256, 292	88937	8	507	93309	5	330, 461
84579	4	195	84748	4	185	84902	0	224				88938	5	507	93310	1	438
84580	0	195	84749	1	185	84903	7	224	85052	1	46, 58, 256, 292	88939	2	507	93311	8	438
84581	7	194, 195	84750	7	263	84904	4	224				88940	8	507	93312	5	449
84582	4	195	84751	4	263	84905	1	224, 225	85053	8	46, 58, 256, 292	88941	5	507	93313	2	449
84583	1	203	84752	1	263	84906	8	224, 225				88942	2	507	93314	9	458
84584	8	203	84753	8	263	84907	5	224, 225	85054	5	46, 58, 256, 292	88946	0	508	93315	6	458
84585	5	205	84754	5	263	84908	2	225				88947	7	508	93317	0	452
84586	2	203	84760	6	263	84909	9	224, 225	88080	1	509, 517	88948	4	508	93318	7	451
84587	9	203	84761	3	263	84910	5	224, 225	88081	8	509, 517	88949	1	509	93321	7	143, 419
84588	6	205	84762	0	263	84911	2	224, 225	88090	0	517	<b>9</b>			93322	4	438
84589	3	203	84763	7	263	84912	9	224, 225	88099	3	510	90901	4	67	93323	1	438
84590	9	203	84764	4	263	84913	6	225	88144	0	408	90902	1	67, 68	93324	8	446
84591	6	205	84770	5	218	84914	3	225	88200	3	401	93034	6	448	93325	5	444
84592	3	204	84771	2	218	84915	0	224, 225	88201	0	401	93101	5	461	93326	2	443
84593	0	204	84772	9	218	84920	4	196, 198	88202	7	401	93102	2	456	93327	9	442
84594	7	204	84773	6	218	84921	1	198	88204	1	401	93105	3	83, 435	93328	6	442
84595	4	204	84774	3	218	84922	8	198	88205	8	401	93110	7	462	93329	3	442
84596	1	204	84775	0	264	84923	5	197, 198	88206	5	401	93111	4	462	93330	9	426, 437
84597	8	205	84776	7	264	84924	2	196, 198	88207	2	401	93112	1	447	93331	6	439
84598	5	204	84777	4	264	84925	9	197, 198	88208	9	401	93114	5	462	93332	3	439
84599	2	204	84778	1	264	84926	6	196, 199	88209	6	401	93115	2	462	93333	0	439
84600	5	205	84779	8	264	84927	3	197, 198, 199	88210	2	401	93116	9	447	93334	7	441
84601	2	200	84780	4	264	84928	0	196, 198, 199	88211	9	401	93120	6	447	93335	4	441
84602	9	200	84781	1	264	84929	7	197, 199	88212	6	401	93121	3	447	93336	1	442
84603	6	200	84782	8	264	84930	3	196, 202	88220	1	270, 271, 525	93122	0	464	93337	8	442
84604	3	200	84783	5	264	84931	0	197, 202	88221	8	270, 525	93123	7	463	93338	5	442
84605	0	200, 201	84785	9	237	84932	7	196, 202	88222	5	271, 525	93124	4	464	93339	2	441
84606	7	201	84786	6	237	84933	4	197, 202	88223	2	271, 525	93125	1	464	93340	8	441
84607	4	200, 201	84787	3	237	84934	1	202	88224	9	271, 525	93126	8	463	93341	5	441
84608	1	201	84788	0	237	84935	8	197, 202	88225	6	270, 525	93127	5	463	93342	2	439
84609	8	201	84789	7	237	84936	5	196, 202	88226	3	270, 525	93129	9	448	93343	9	439
84610	4	201	84790	3	237	84937	2	197, 202	88227	0	271, 525	93134	3	448	93344	6	439
84611	1	201	84800	9	181	84938	9	196, 202	88228	7	271, 525	93138	1	444	93345	3	438
84612	8	201	84801	6	181	84939	6	203	88229	4	271, 525	93139	8	444	93346	0	437
84613	5	201	84802	3	181	84940	2	203	88244	7	408	93140	4	444	93347	7	449
84614	2	200, 201	84803	0	180, 181	84941	9	198, 199, 534	88245	4	408	93141	1	461	93348	4	449
84615	9	201	84804	7	180, 181	84942	6	197, 198, 199, 534	88246	1	408	93144	2	461	93349	1	449
84616	6	201	84805	4	181				88256	0	527	93145	9	461	93350	7	444
84620	3	63, 259	84806	1	181	84943	3	196, 198, 199, 534	88271	3	524	93146	6	461	93351	4	445
84621	0	63, 259	84807	8	180, 181				88285	0	408	93147	3	461	93352	1	445
84622	7	238	84808	5	180, 181	84944	0	198, 199	88287	4	521	93148	0	461	93353	8	445
84623	4	238	84809	2	180	84945	7	198, 199, 534	88288	1	521	93150	3	524	93354	5	445
84624	1	251	84810	8	180, 181	84946	4	198, 199, 534	88598	1	501	93151	0	524	93355	2	446
84625	8	262	84811	5	181	84950	1	252	88608	7	487	93152	7	448	93356	9	447
84626	5	262	84812	2	181	84951	8	252, 253	88609	4	501	93153	4	448	93357	6	447
84627	2	262	84813	9	181	84952	5	253	88617	9	511	93154	1	523	93358	3	450
84650	0	201	84814	6	180, 181	84953	2	253	88618	6	511	93155	8	523	93360	6	450
84651	7	201	84815	3	180	84954	9	253	88626	1	501	93156	5	523	93361	3	450
84652	4	201	84816	0	180	84955	6	252	88627	8	501	93157	2	523	93364	4	440
84653	1	201	84817	7	180	84956	3	252	88628	5	501	93160	2	462	93365	1	440
84654	8	201	84818	4	180	84957	0	252	88636	0	501	93161	9	463	93366	8	443
84655	5	201	84819	1	180	84958	7	252	88637	7	487	93162	6	463	93367	5	437
84670	8	176	84820	7	192	84959	4	252	88640	7	486	93163	3	523	93368	2	448
84671	5	176	84821	4	192	84960	0	215, 248	88642	1	486	93164	0	446	93369	9	448
84672	2	176	84822	1	192	84961	7	215, 248	88643	8	499	93165	7	446	93370	5	439
84673	9	176	84823	8	193	84990	7	186	88644	5	499	93166	4	458	93371	2	440
84674	6	176, 177	84824	5	192	84991	4	186	88645	2	499	93167	1	458	93372	9	440
84675	3	176, 177	84825	2	192	85000	2	175	88688	9	513	93168	8	458	93373	6	440
84676	0	176, 177	84826	9	192	85002	6	175	88701	5	509	93169	5	458	93374	3	440
84677	7	176, 177	84827	6	192	85003	3	175	88717	6	512	93170	1	463	93375	0	441
84678	4	176, 177	84828	3	193	85005	7	175	88718	3	512	93171	8	459	93380	4	457
84680	7	178	84829	0	193	85006	4	175	88727	5	509	93173	2	458	93		

**DE Impressum**

Herausgeber: Assheuer + Pott GmbH & Co. KG, Talweg 11, 59846 Sundern, Tel. +49 2933 97350, info@aps-germany.de, www.aps-germany.de

Gestaltung: Assheuer + Pott GmbH & Co. KG · Druck: Druck- und Verlagshaus Fromm GmbH & Co. KG, Breiter Gang 10-16, 49074 Osnabrück

Wir behalten uns das Recht vor, die angegebenen Spezifikationen jederzeit zu ändern. Irrtum, Druckfehler und technische Änderungen vorbehalten. Artikelbeschreibungen sowie Abbildungen und Fotodarstellungen sind ohne Gewähr. Alle Angebote ohne Dekoration. Alle Preise verstehen sich unverbindlich (UVP) in Euro zuzüglich der gesetzlichen Mehrwertsteuer.

© 2020 - Die Vervielfältigung dieses Kataloges - auch wenn partial - muss ausschließlich von der Assheuer + Pott GmbH & Co. KG genehmigt werden.

Bildnachweis: Niklas Thiemann Fotodesign · Shutterstock

**GB Imprint**

Editor: Assheuer + Pott GmbH & Co. KG, Talweg 11, 59846 Sundern, Germany, Tel. +49 2933 97350, info@aps-germany.de, www.aps-germany.de

Design: Assheuer + Pott GmbH & Co. KG - Print: Druck- und Verlagshaus Fromm GmbH & Co. KG, Breiter Gang 10-16, 49074 Osnabrück, Germany

We reserve the right to alter at any time the specifications stated without notice. Errors, printing error and technical changes reserved. Item description as well as images and illustrations are without guaranty. All offers are without decoration. All prices are without commitment (RRP) in Euro and exclude the legal VAT prescribed by law.

© 2020 - This catalogue may not be reproduced in whole or in part unless specific prior written authorization of Assheuer + Pott GmbH & Co. KG.

Picture credits: Niklas Thiemann Fotodesign · Shutterstock

**ES Impressum**

Editor: Assheuer + Pott GmbH & Co. KG, Talweg 11, 59846 Sundern, Alemania, Tel. +49 2933 97350, info@aps-germany.de, www.aps-germany.de

Diseño gráfico: Assheuer + Pott GmbH & Co. KG - Impresión: Druck- und Verlagshaus Fromm GmbH & Co. KG, Breiter Gang 10-16, 49074 Osnabrück, Alemania

Nos reservamos el derecho de efectuar modificaciones en cualquier momento, sin aviso previo. Salvo errores de imprenta o impresión o cambios técnicos. La descripción de los artículos, sus imágenes e ilustraciones son sin garantía. Los artículos se ofrecen sin decoración. Todos los precios indicados son precios sugeridos (PVR) en euros y a dichos precios se deberá añadir el impuesto sobre el valor añadido legal vigente.

© 2020 - Todas las reproducciones, aunque parciales, de este catálogo tienen que ser autorizadas por escrito por Assheuer + Pott GmbH & Co. KG.

Derechos de la imagen: Niklas Thiemann Fotodesign · Shutterstock

**FR Impressum**

Éditeur: Assheuer + Pott GmbH & Co. KG, Talweg 11, 59846 Sundern, Allemagne, Tel. +49 2933 97350, info@aps-germany.de, www.aps-germany.de

Design: Assheuer + Pott GmbH & Co. KG - Impression: Druck- und Verlagshaus Fromm GmbH & Co. KG, Breiter Gang 10-16, 49074 Osnabrück, Allemagne

Nous nous réservons le droit de modifier à tout moment les spécifications. Toutes erreurs, fautes d'impression et modifications techniques sont réservées. Les descriptions d'articles, les illustrations et les photos sont sans garantie. Toutes les articles s'entendent hors décoration. Tous les prix sont donnés sans engagement (PVC) et s'entendent en Euro et T. V. A. légale en vigueur non incluse.

© 2020 - Toute reproduction même partielle de ce catalogue est interdite sauf autorisation expresse de Assheuer + Pott GmbH & Co. KG.

Crédit photo: Niklas Thiemann Fotodesign · Shutterstock



buffet | tabletop | bar

**Assheuer + Pott GmbH & Co. KG**

Talweg 11 | 59846 Sundern

Germany

Phone: +49 (0) 29 33 / 97 35 - 0

E-Mail: [info@aps-germany.de](mailto:info@aps-germany.de)

[aps-germany.de](http://aps-germany.de)

KATALOG NR 47

CATALOG NO 47

CATÁLOGO N° 47

CATALOGUE N° 47



Follow us on  
[aps\\_germany](https://www.instagram.com/aps_germany)

